

A technical drawing of a trapezoidal shape, possibly a piece of paper or a component. The shape is outlined in black. A red line is drawn across the upper portion of the shape, indicating a fold line. The text "Flop and use for the other side" is written in black, italicized font, positioned below the red line and above the bottom edge of the shape.

Flop and use for the other side

Copyright ©2020 13thSquadron. All Rights Reserved.
Commercial use of our plans are prohibited.

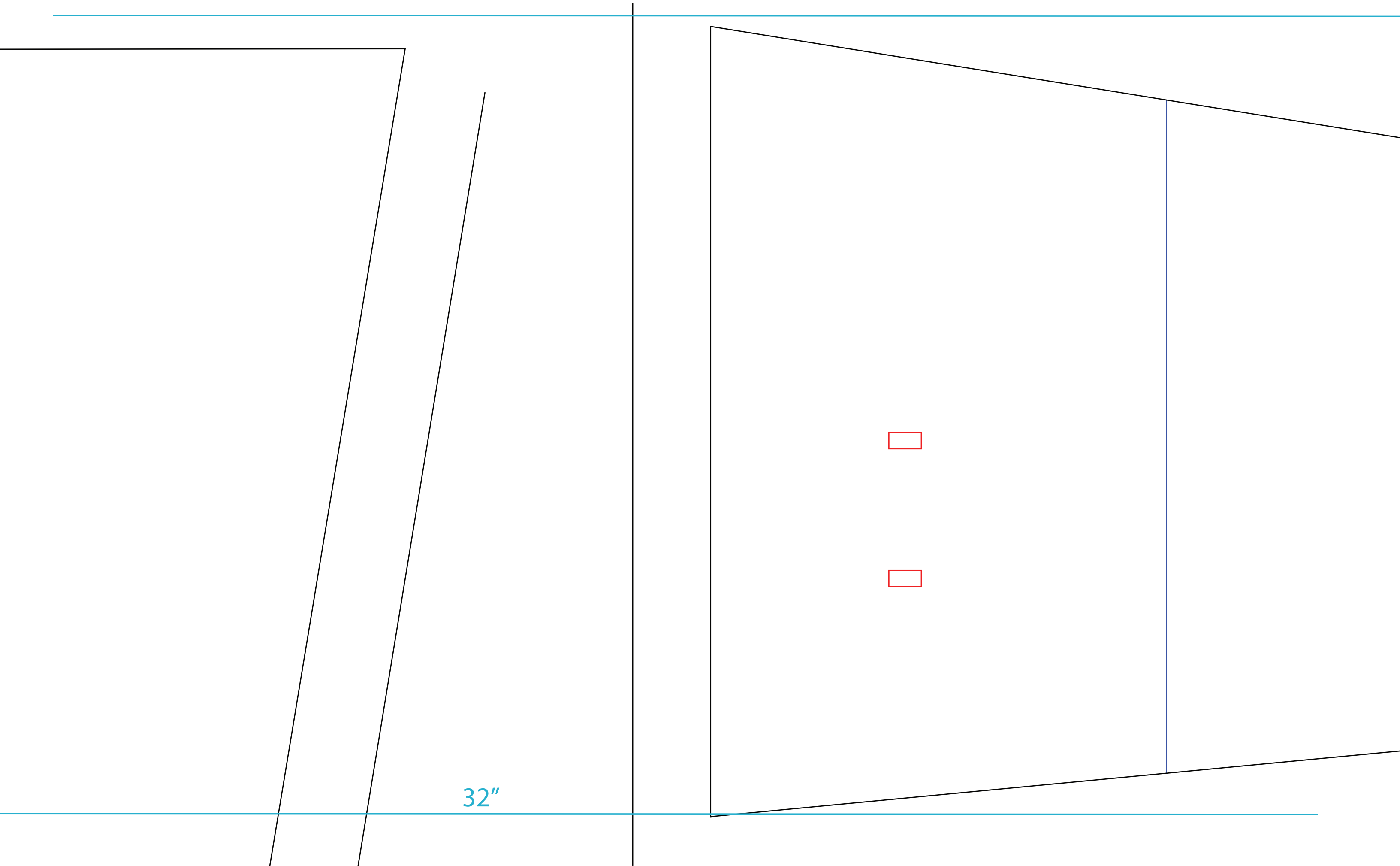

32"

32"

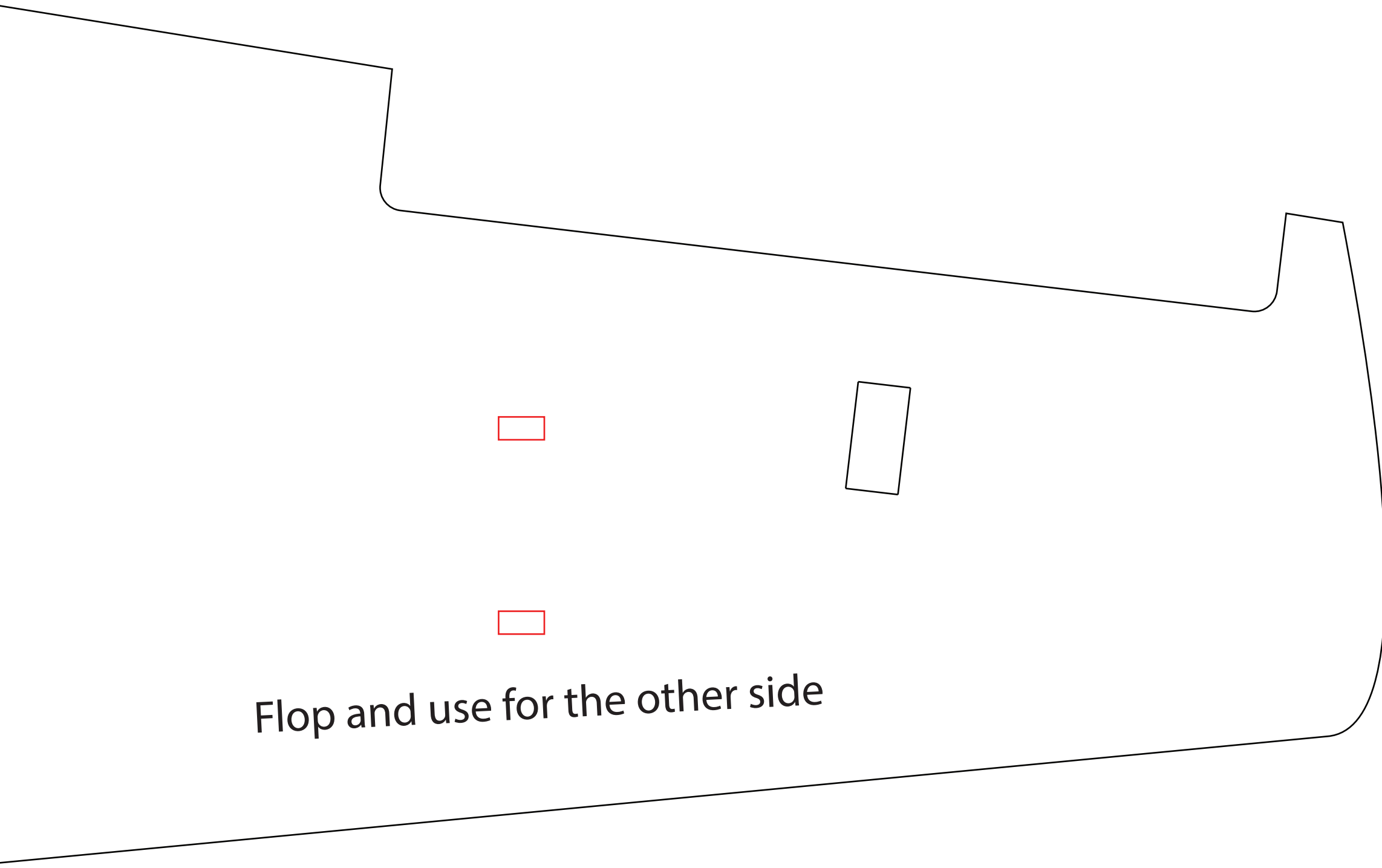

Flop and use for the other side

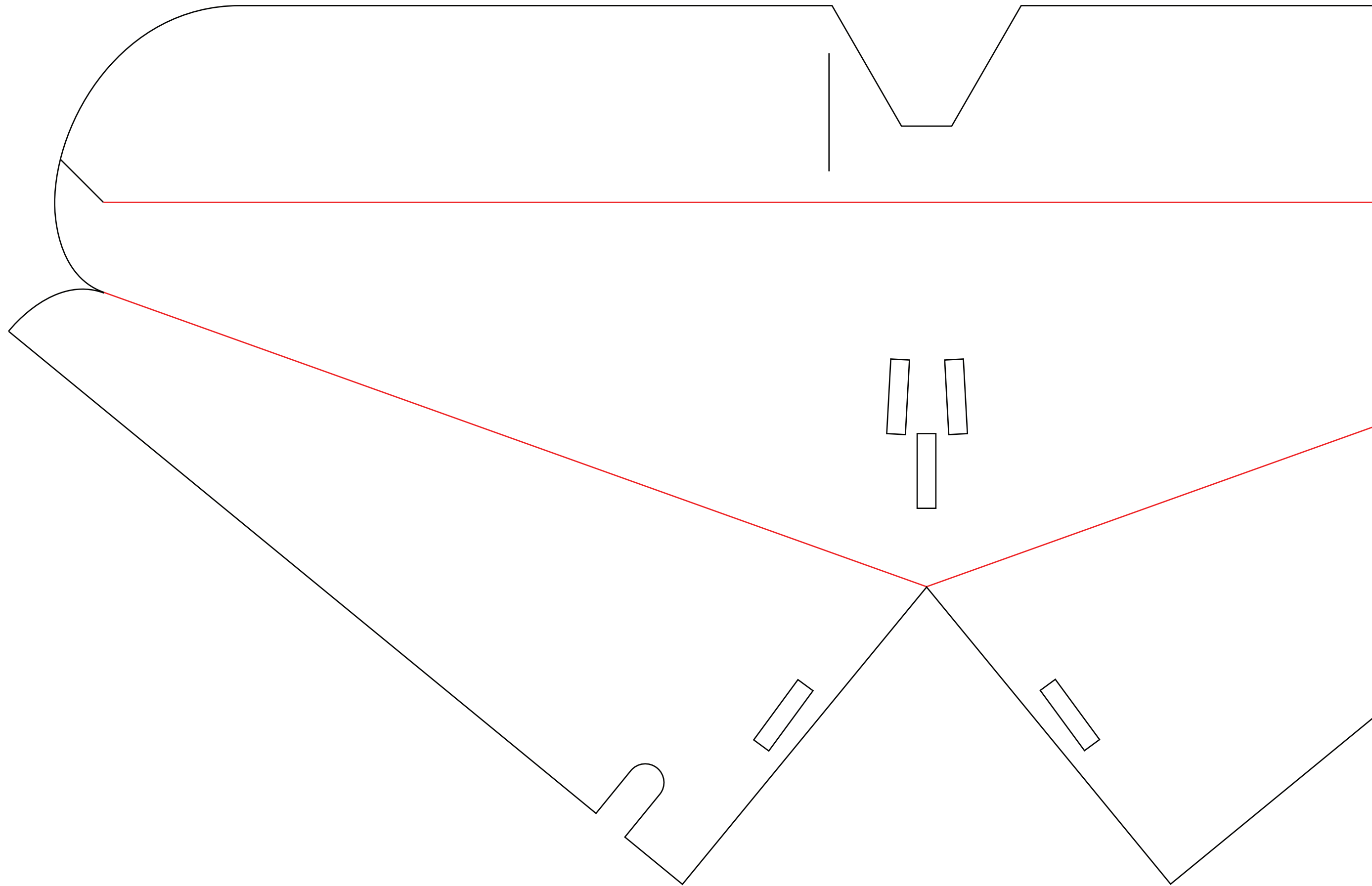

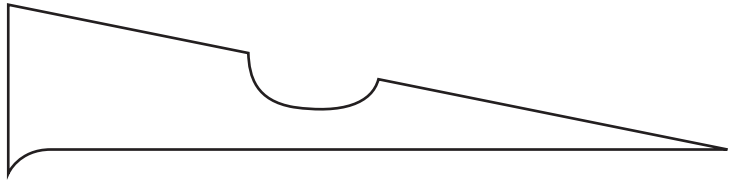
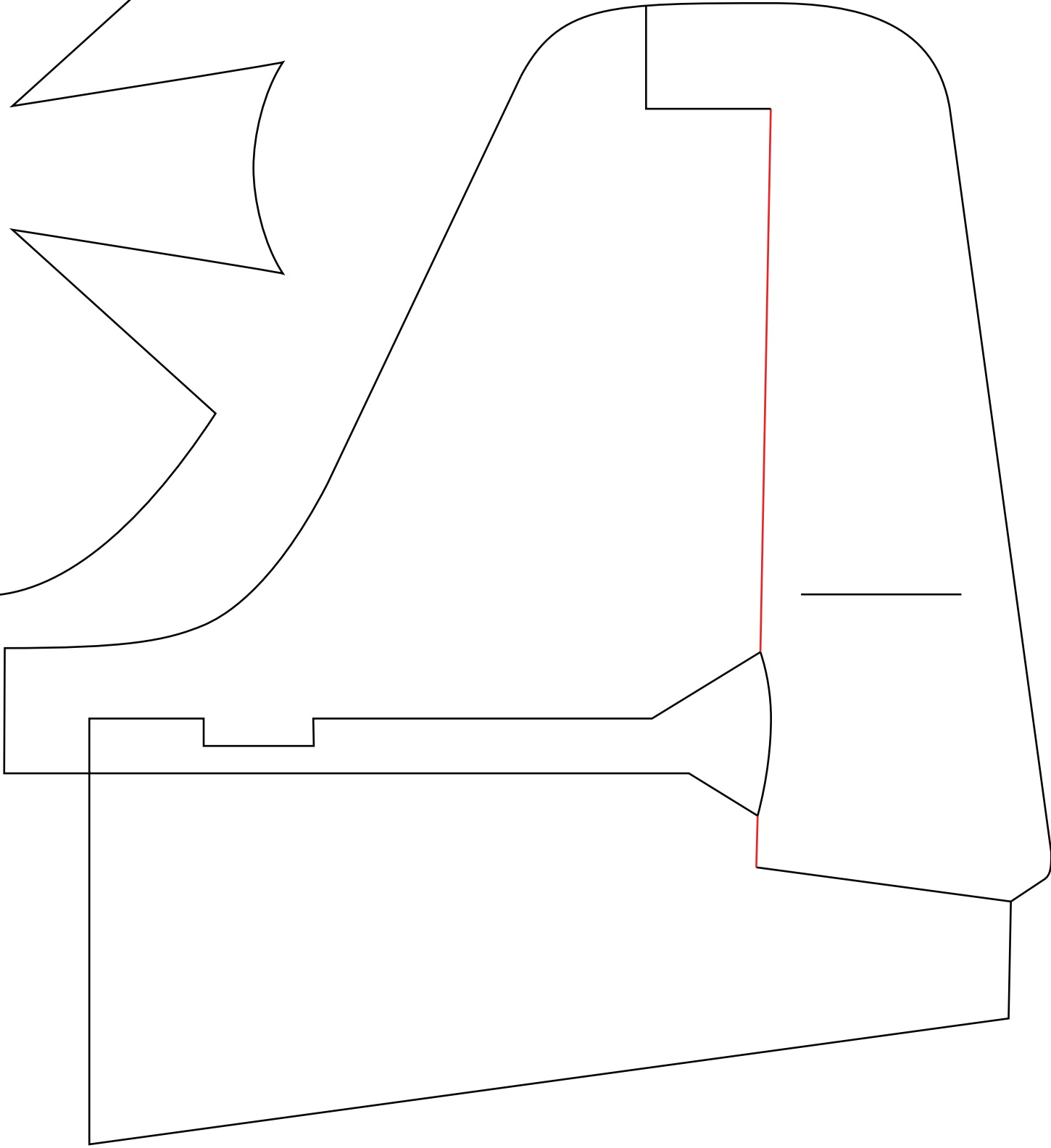
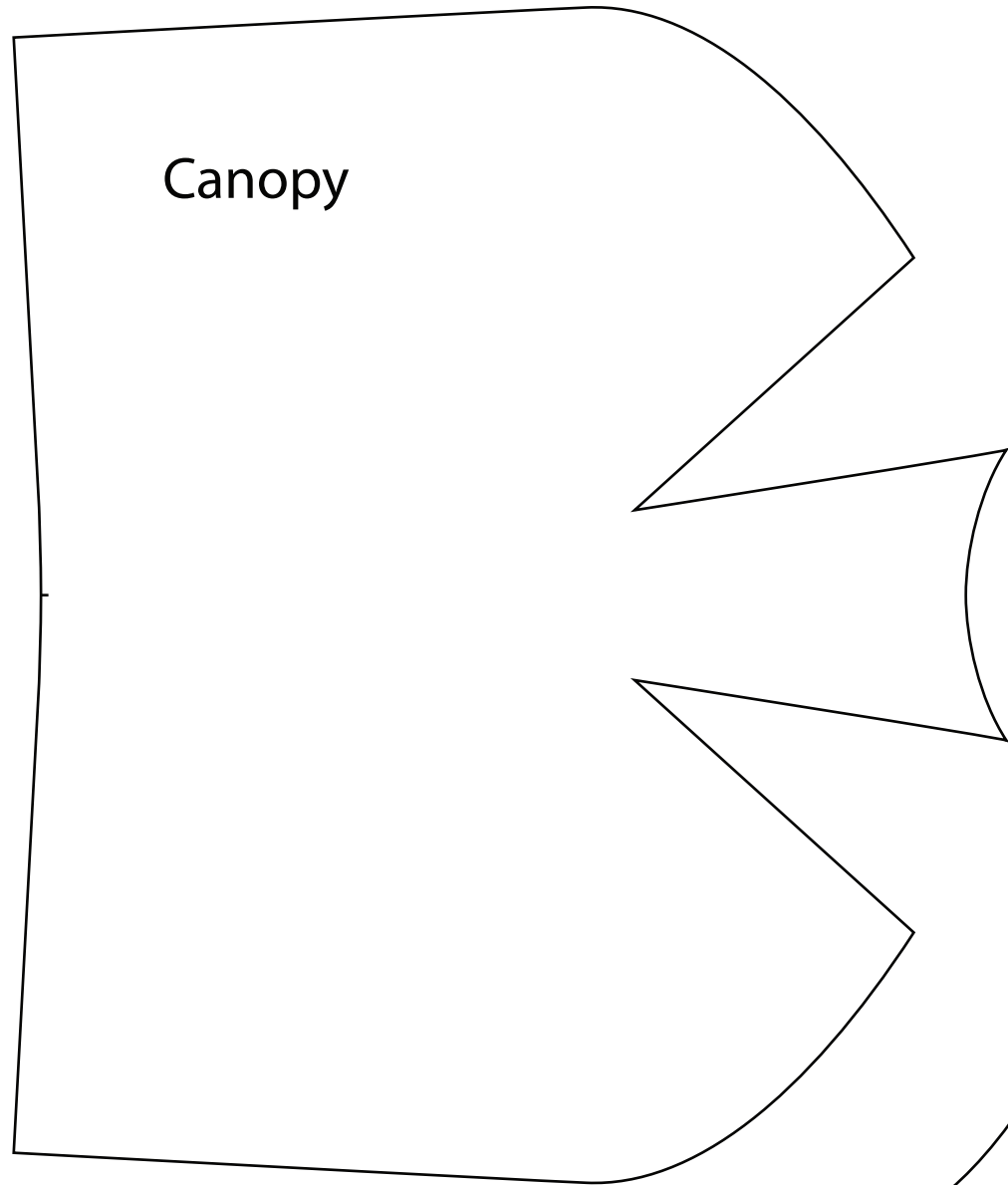
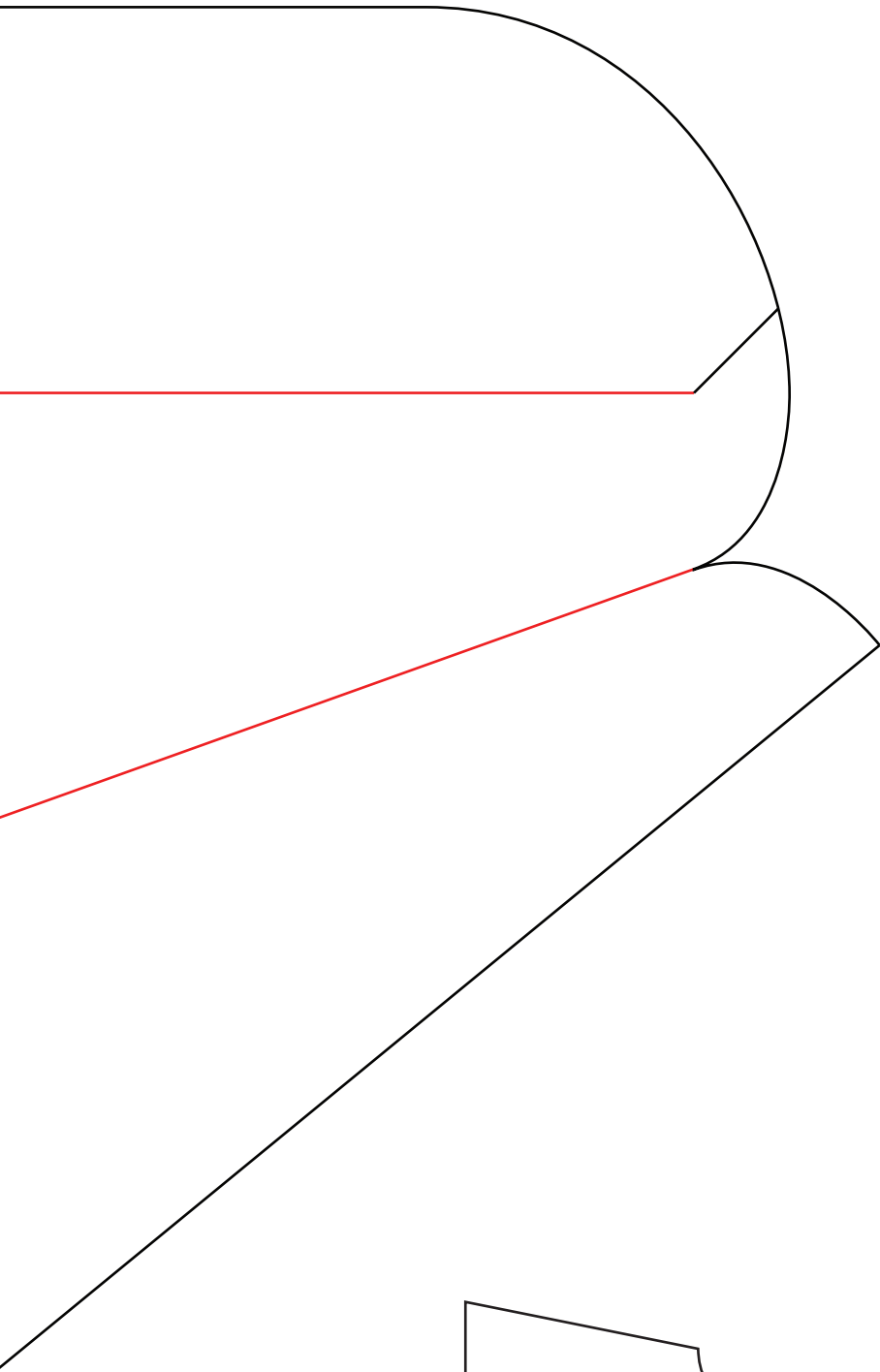

These are the fairings between the rudder and the elevator.

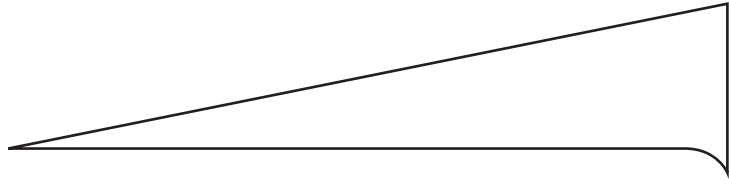

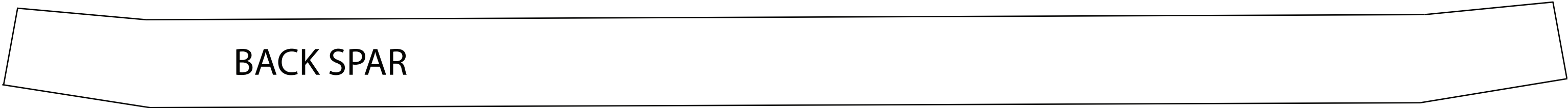
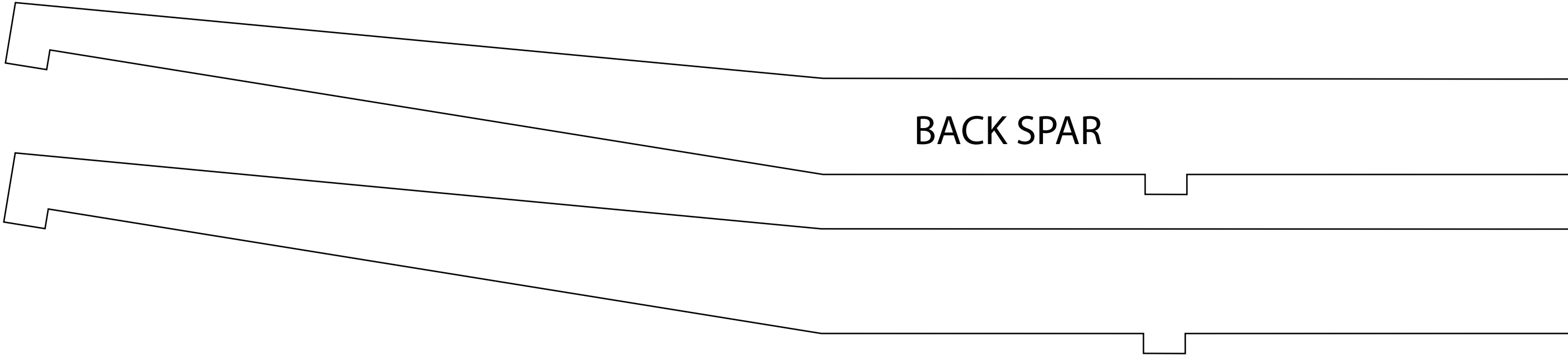

32"

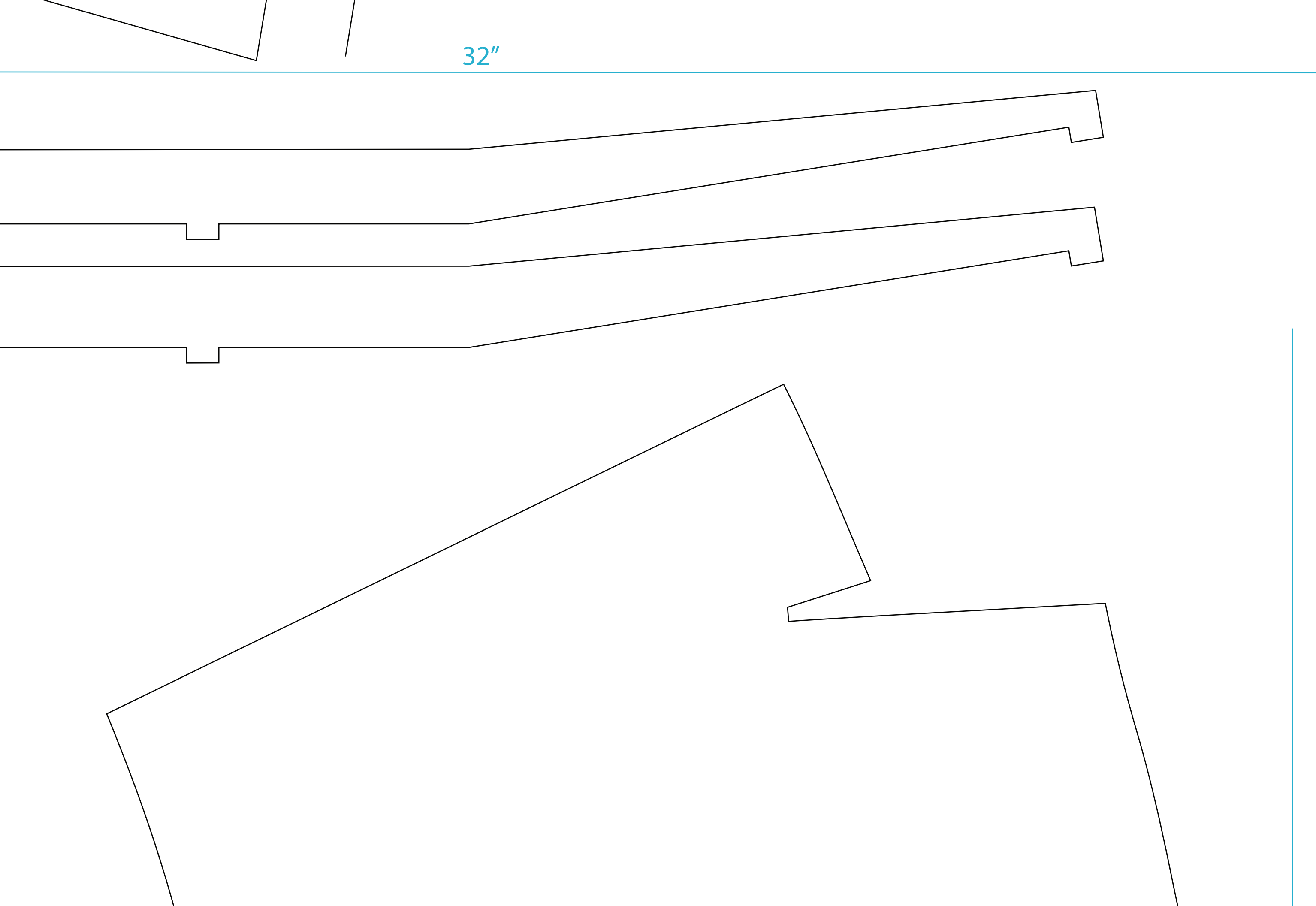

17"

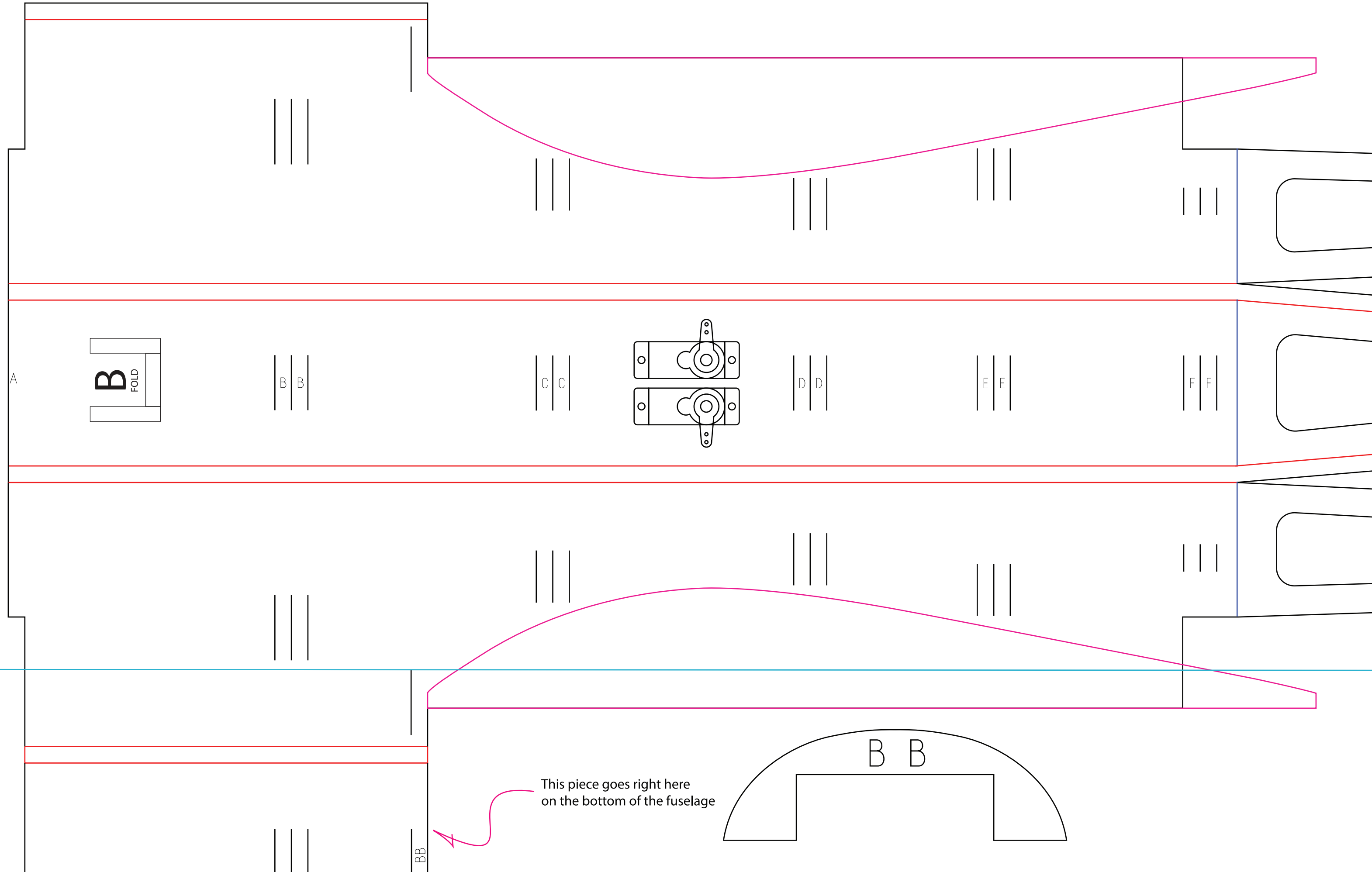

This piece goes right here
on the bottom of the fuselage

BB

B B

B

FOLD

B B

C C

D D

E E

F F

|||

|||

|||

|||

|||

|||

|||

|||

|||

|||

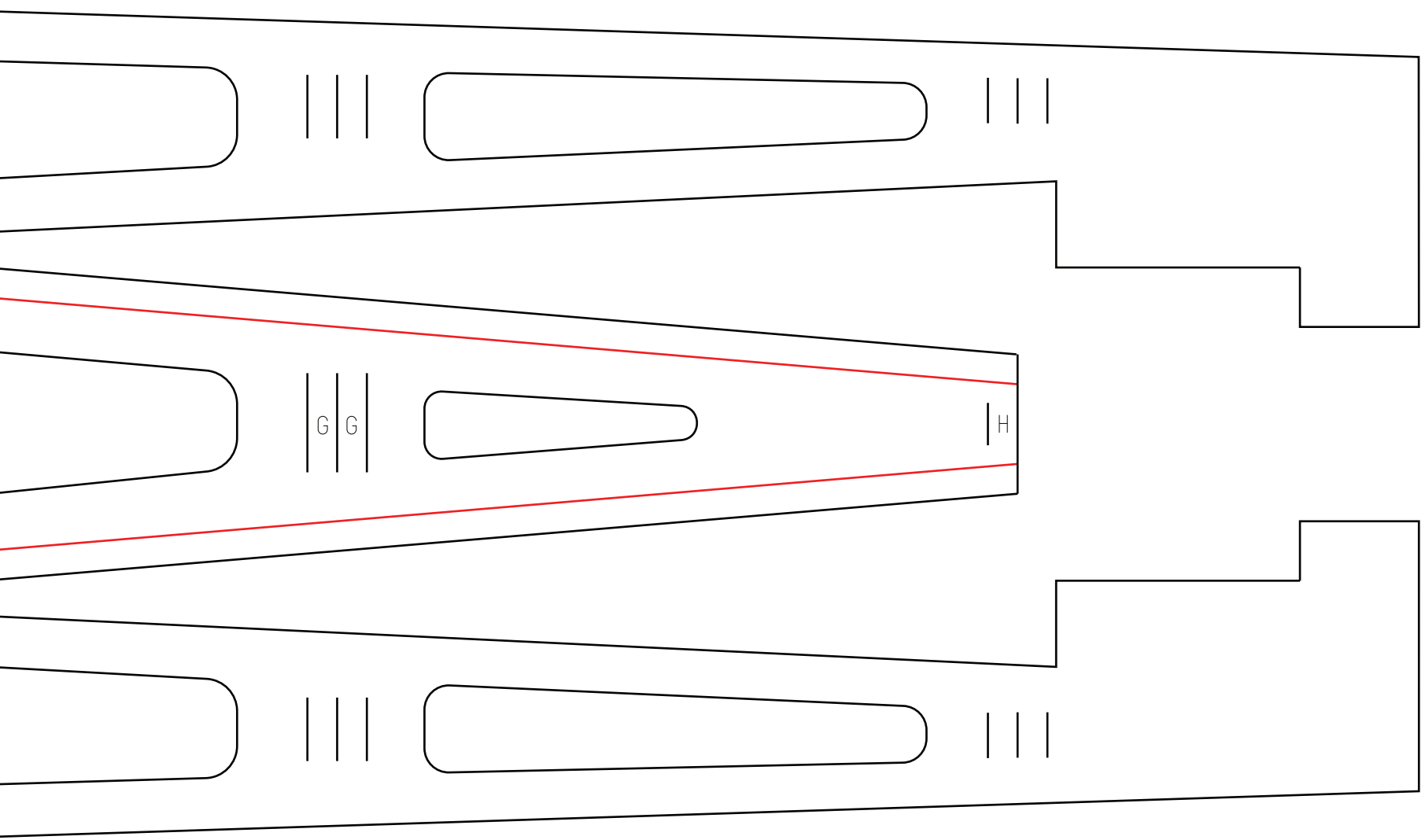

32"

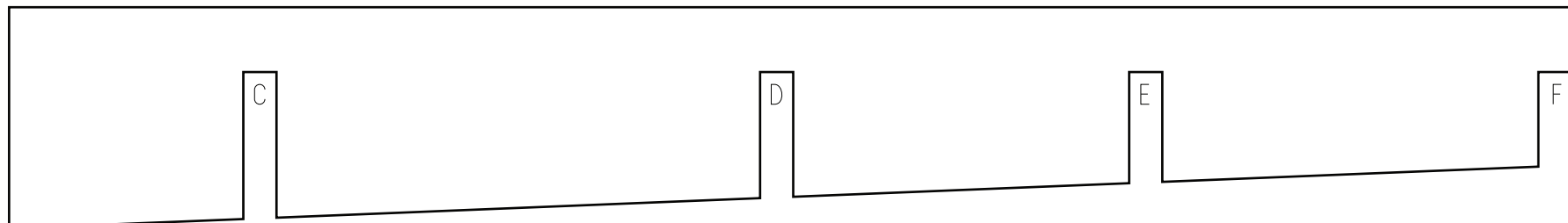

FF

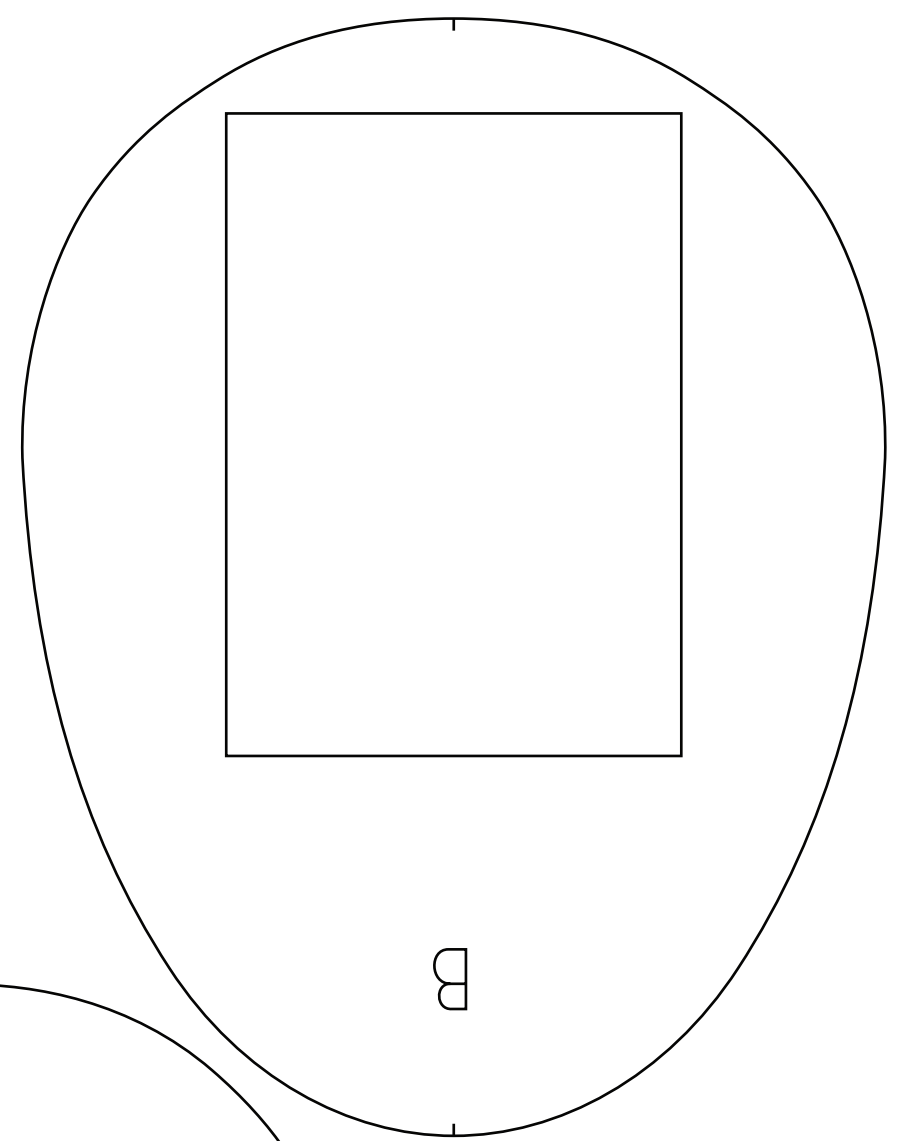
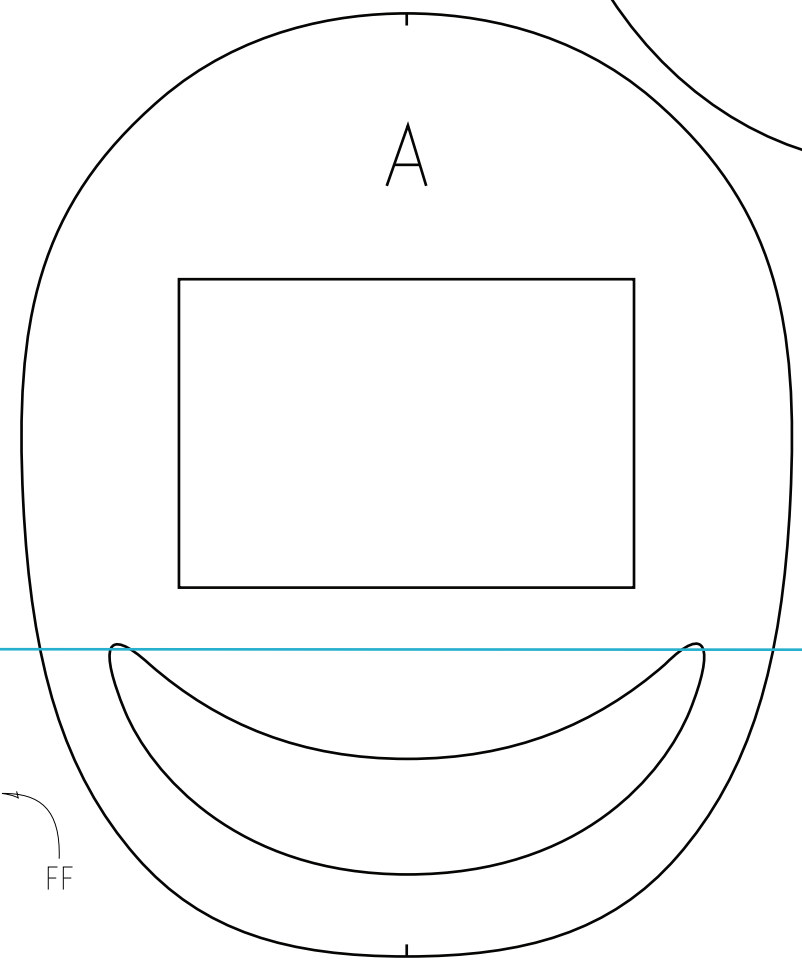

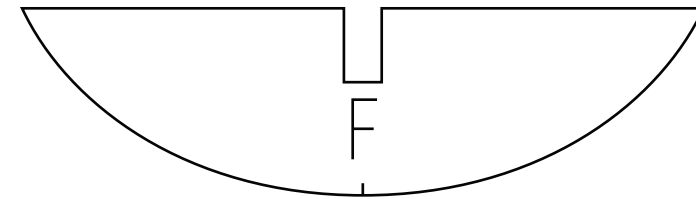
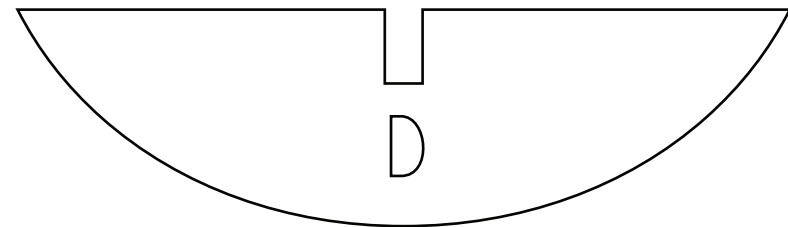
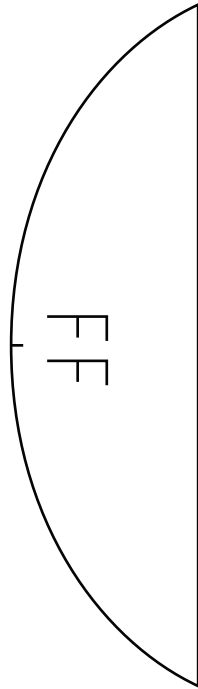
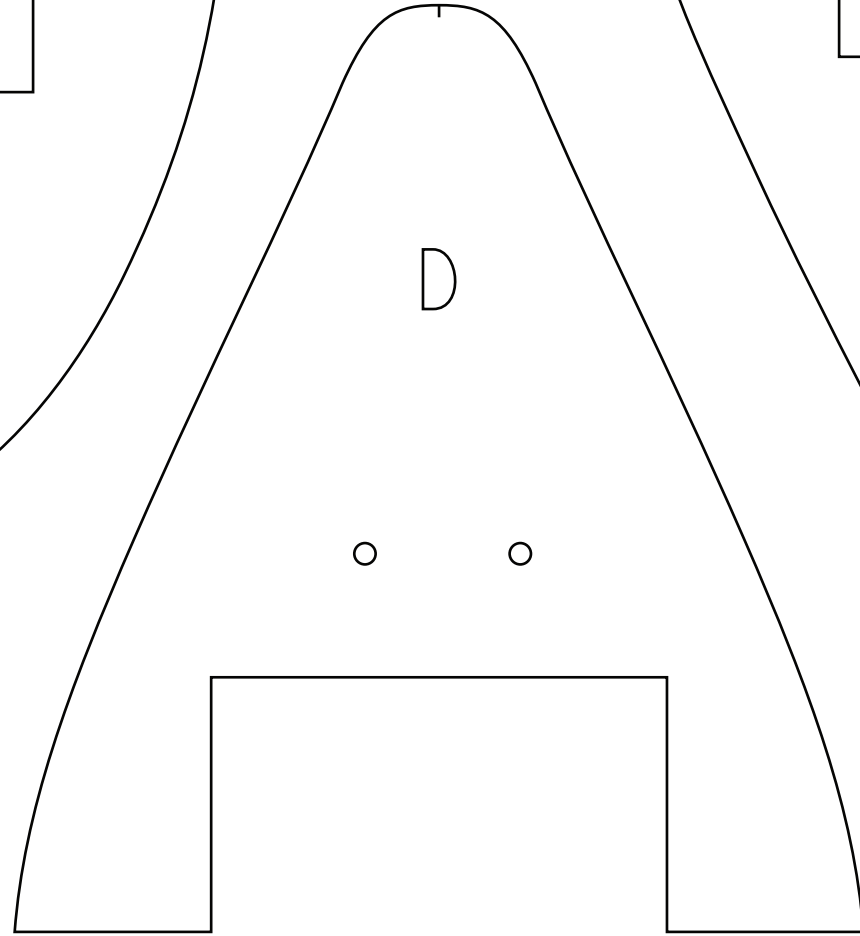
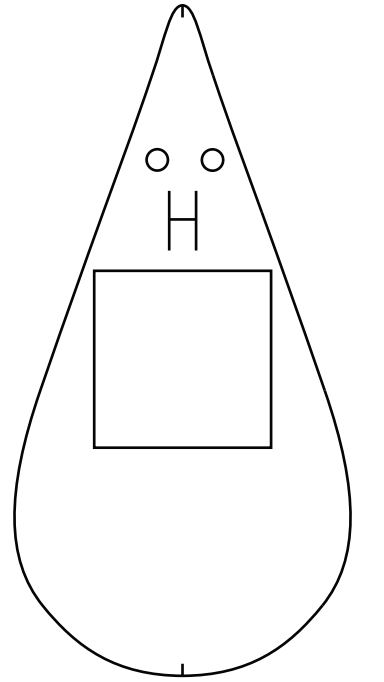
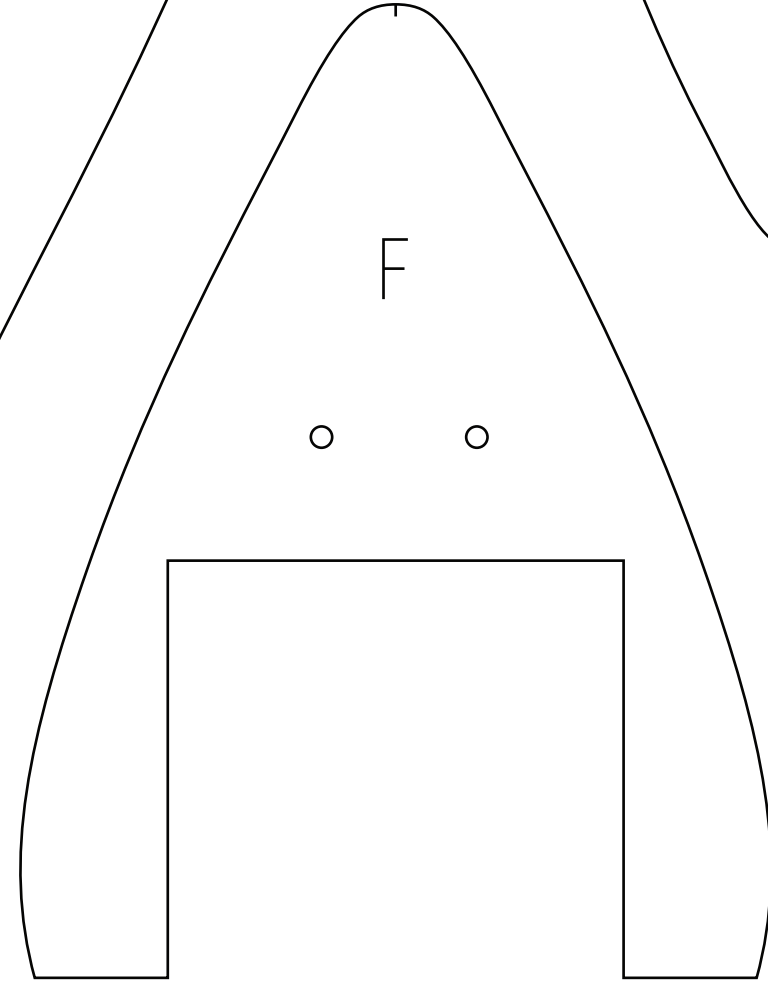
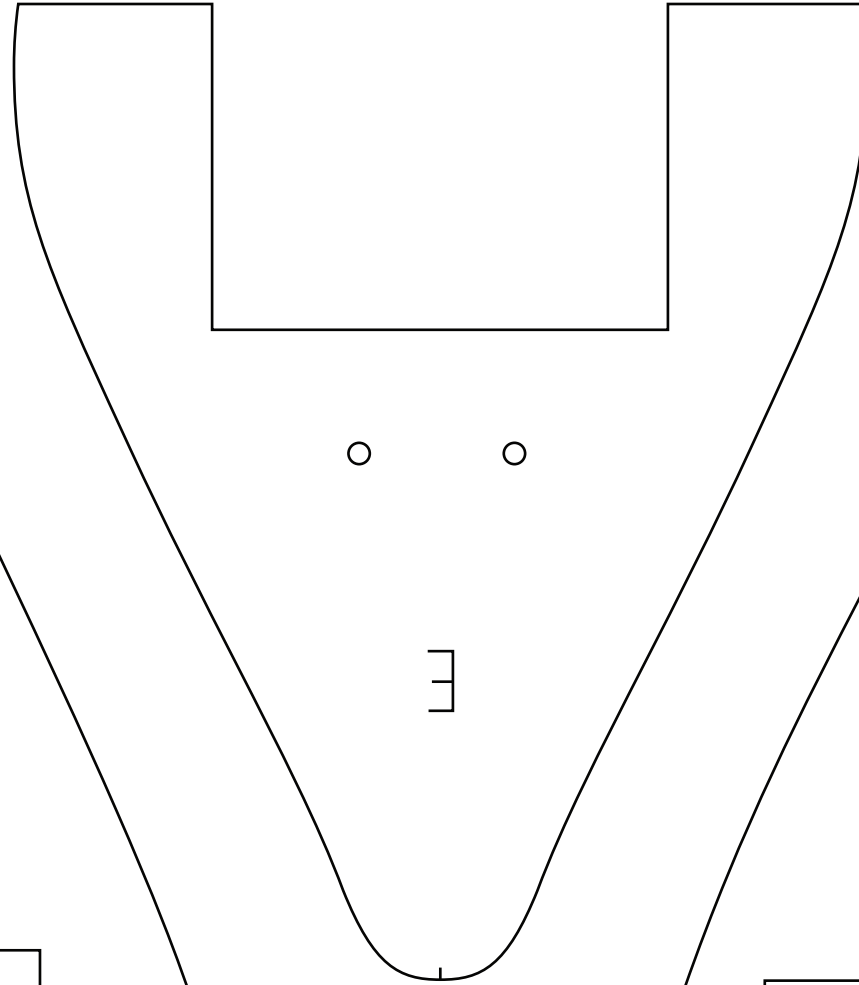
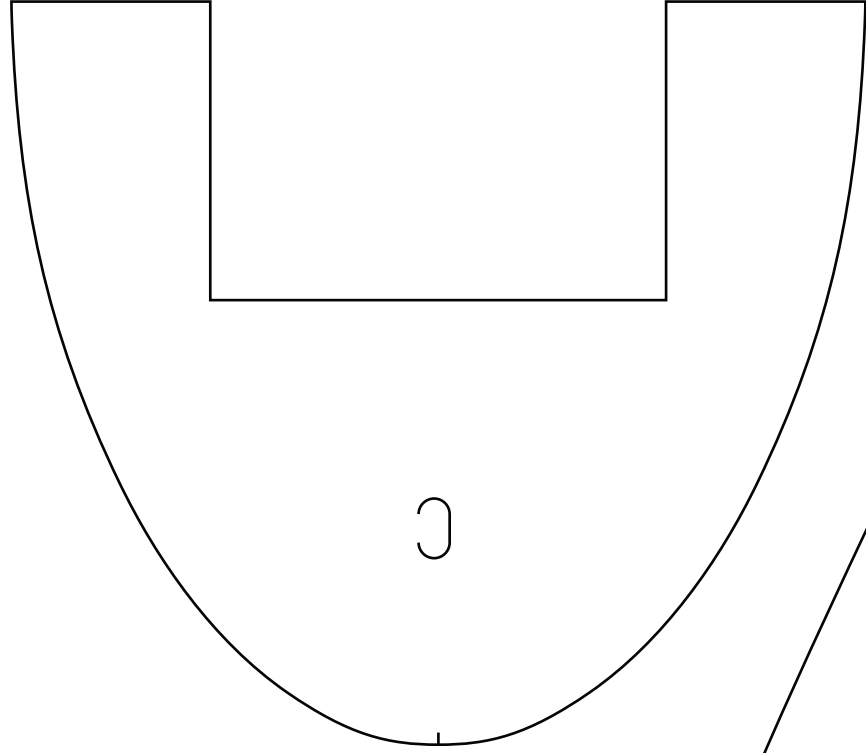
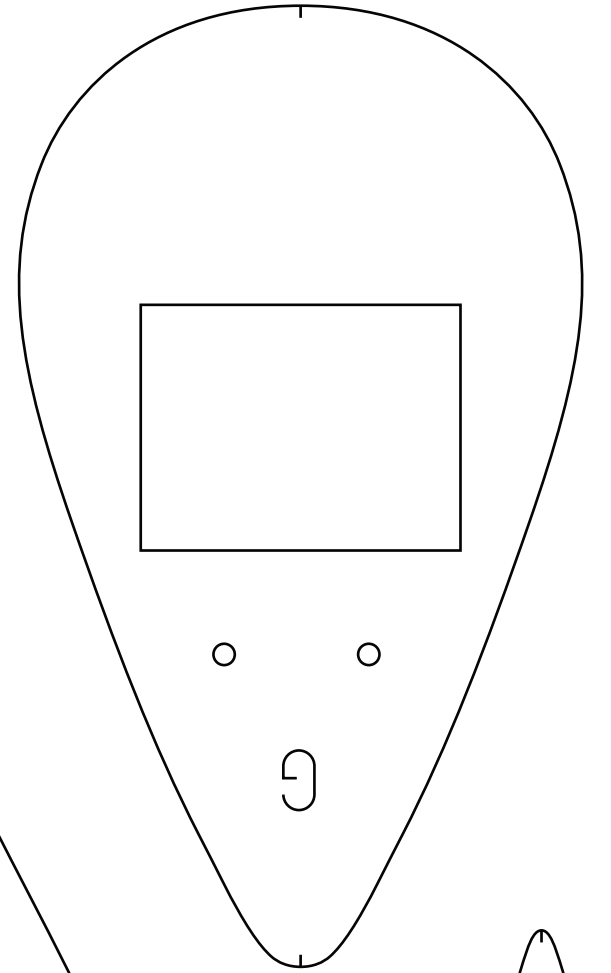
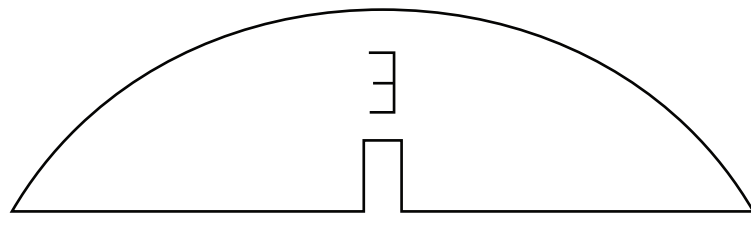
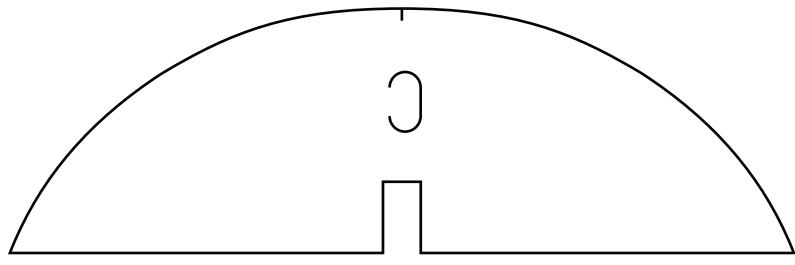

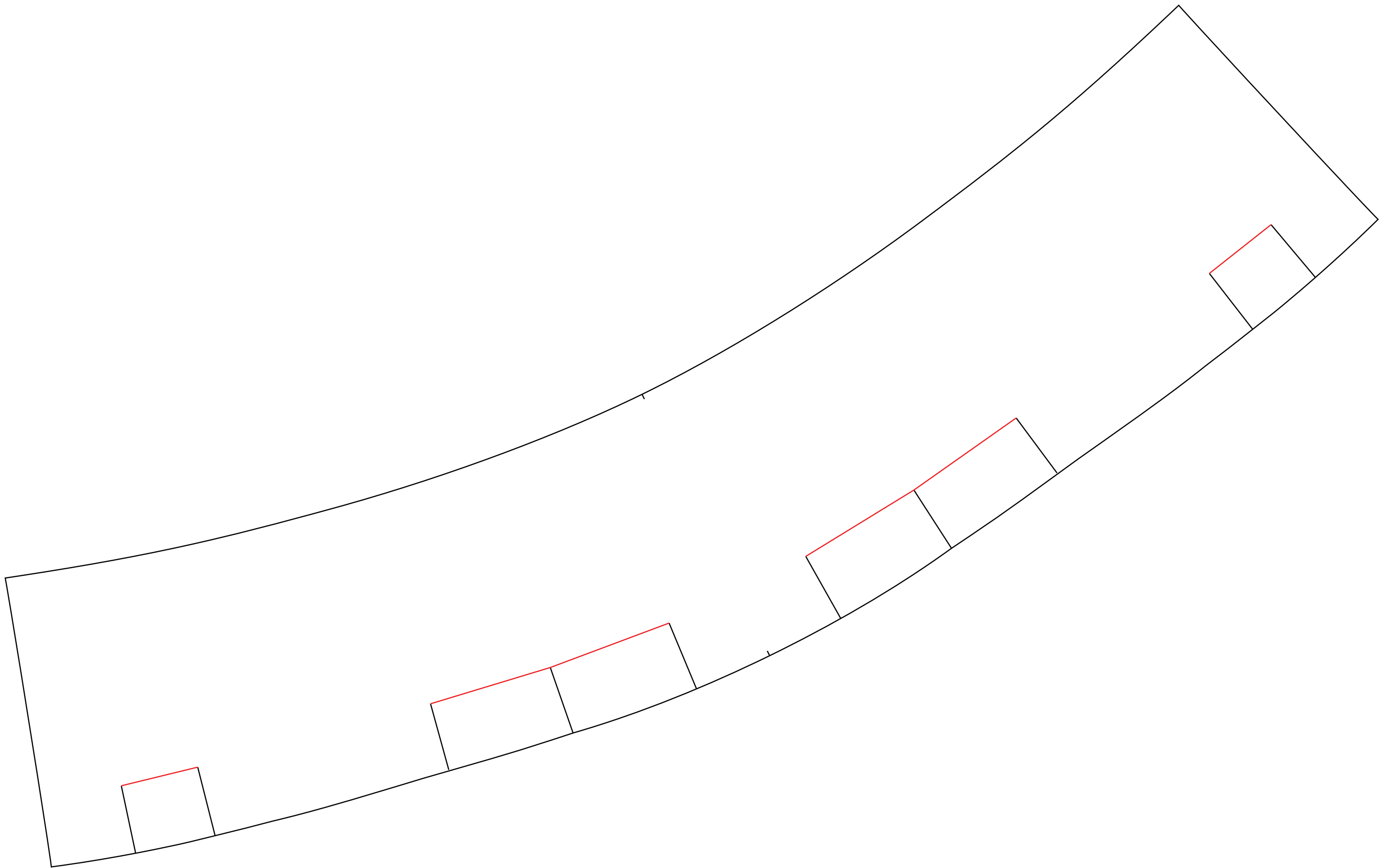

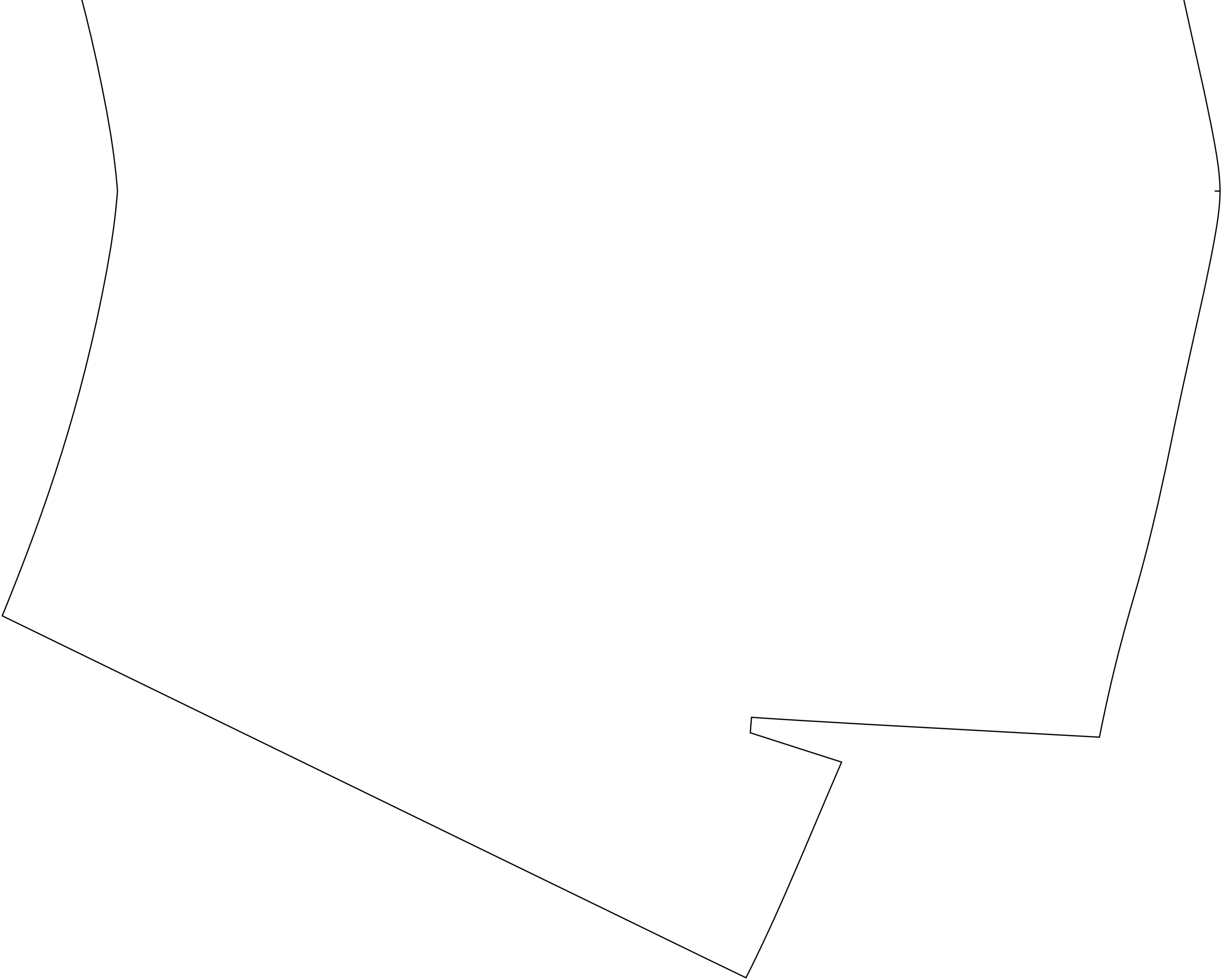

17"

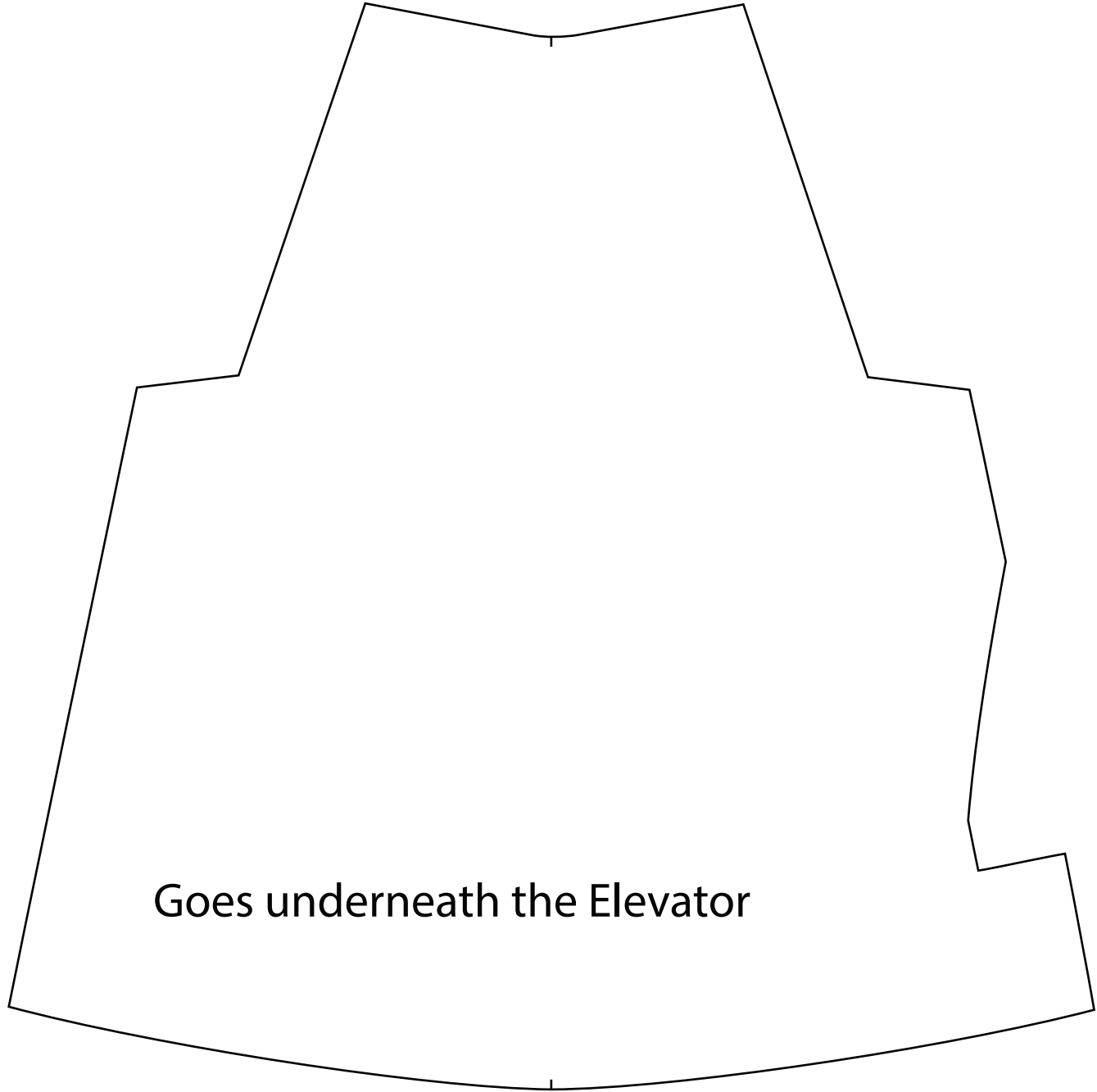

Goes underneath the Elevator

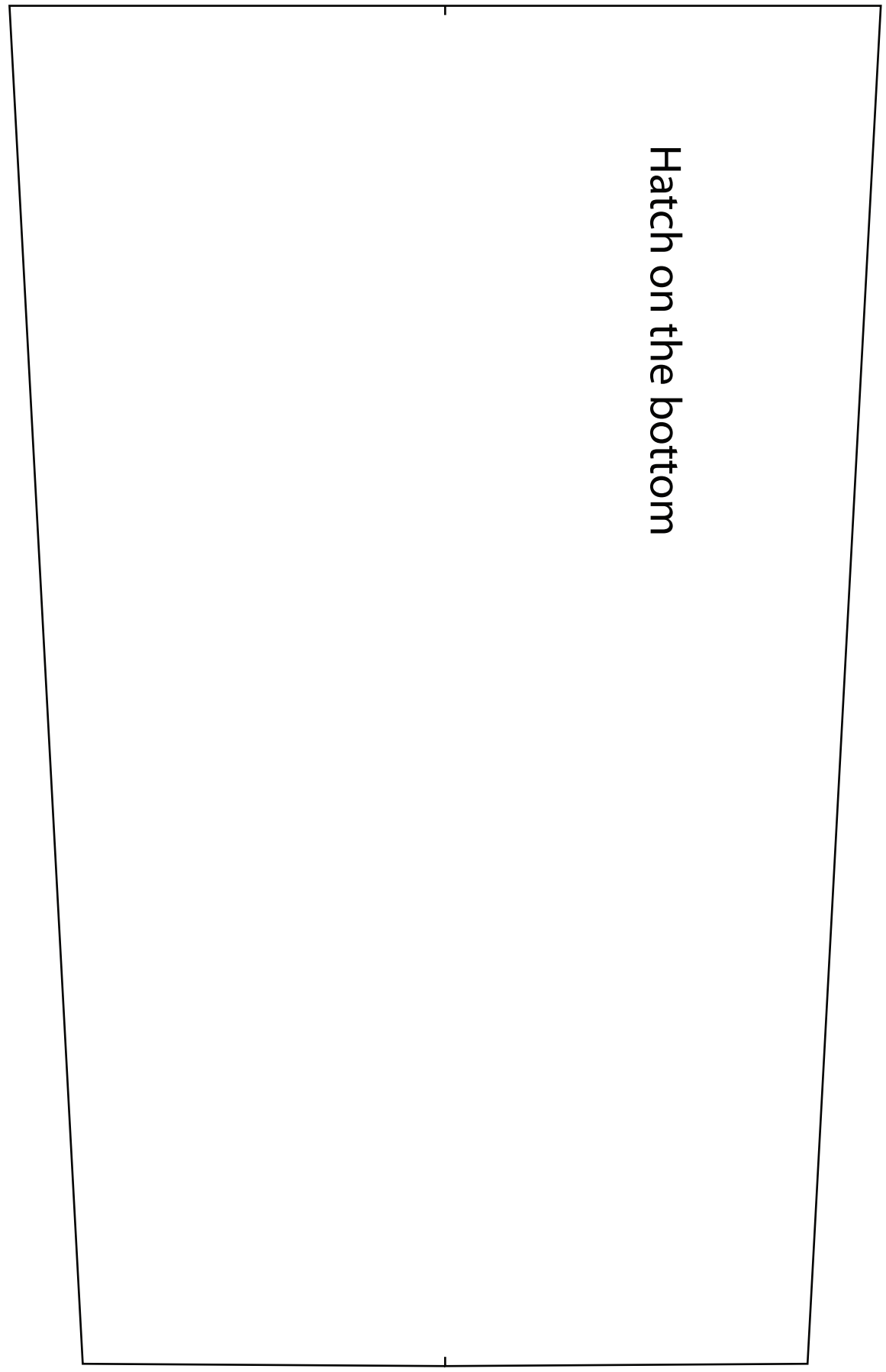

Hatch on the bottom

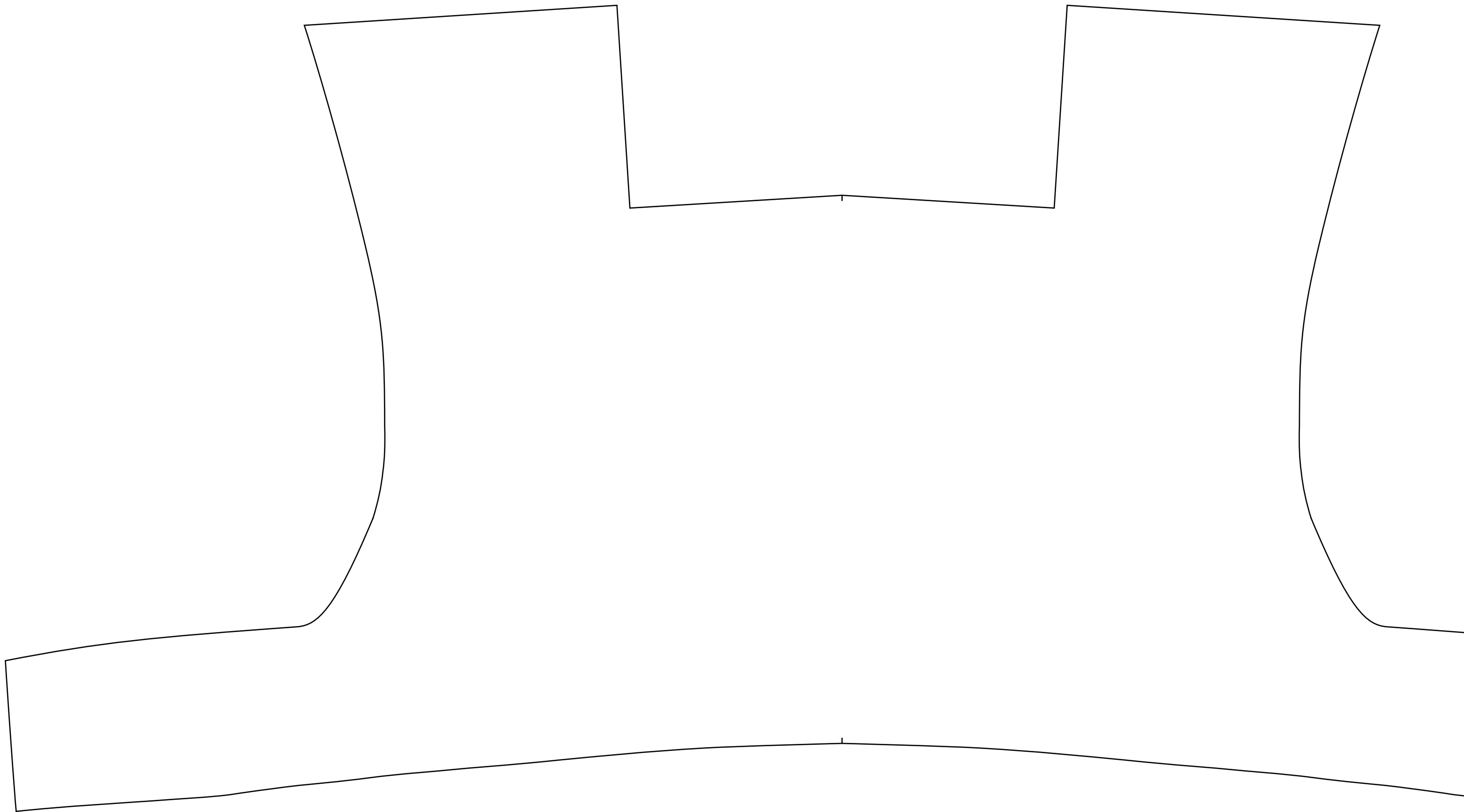

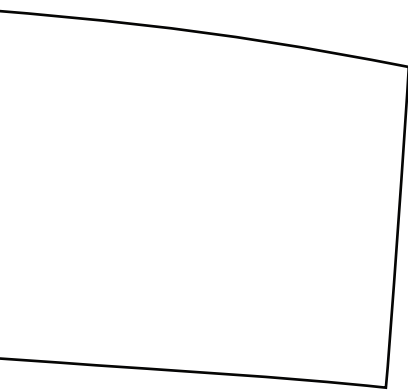
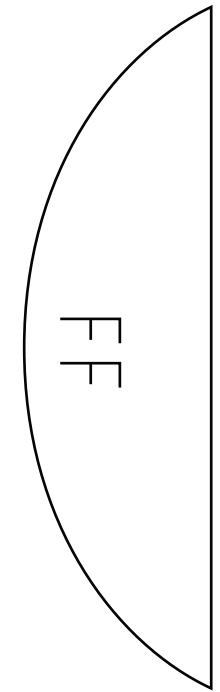
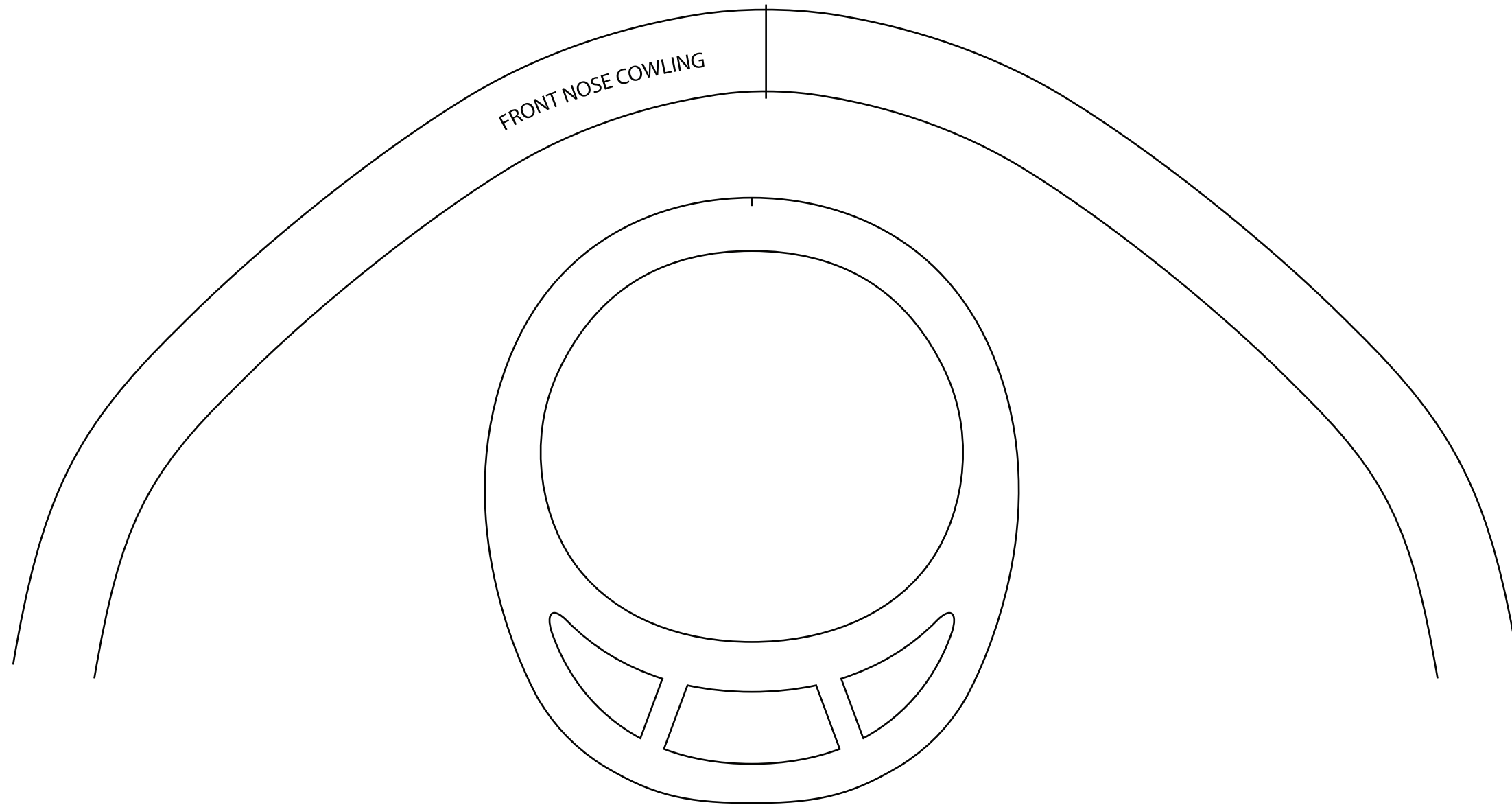

32"