

A technical drawing of a trapezoidal shape, possibly a piece of paper or a component. The shape is outlined in black. A red line is drawn across the upper portion of the shape, indicating a fold line. The text "Flop and use for the other side" is written in black, italicized font, centered within the shape.

Flop and use for the other side

Copyright ©2020 13thSquadron. All Rights Reserved.
Commercial use of our plans are prohibited.

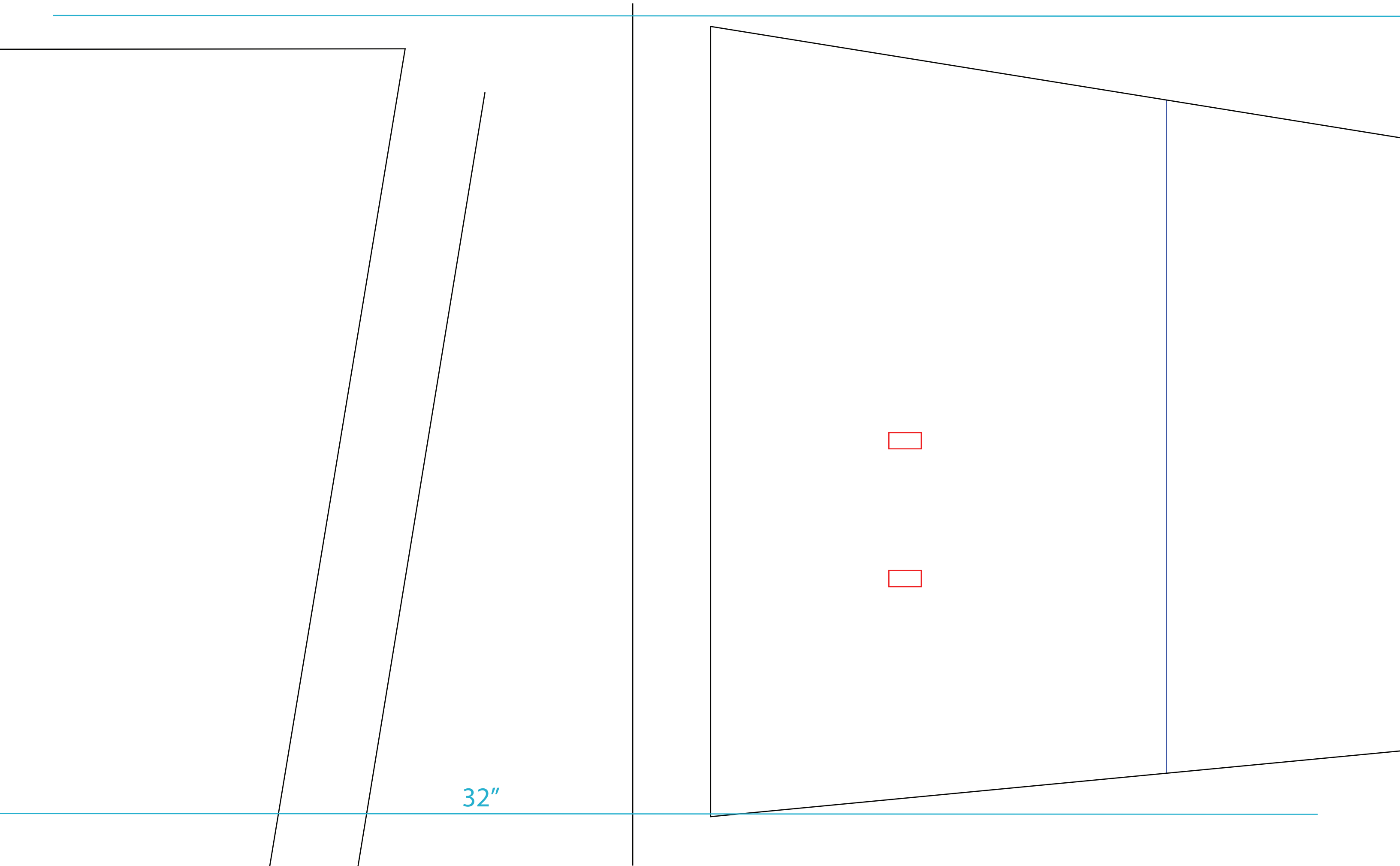

32"

32"

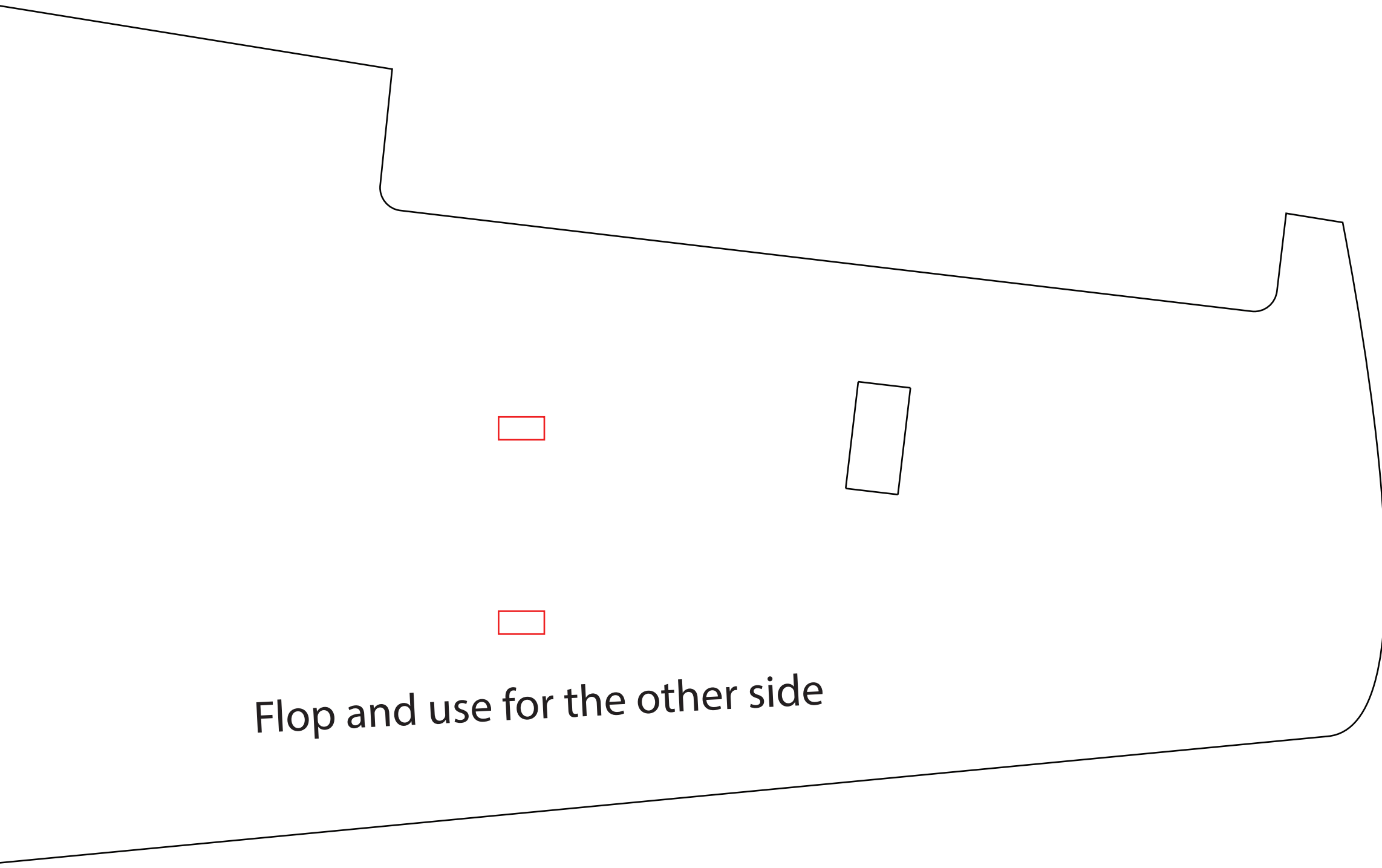

Flop and use for the other side

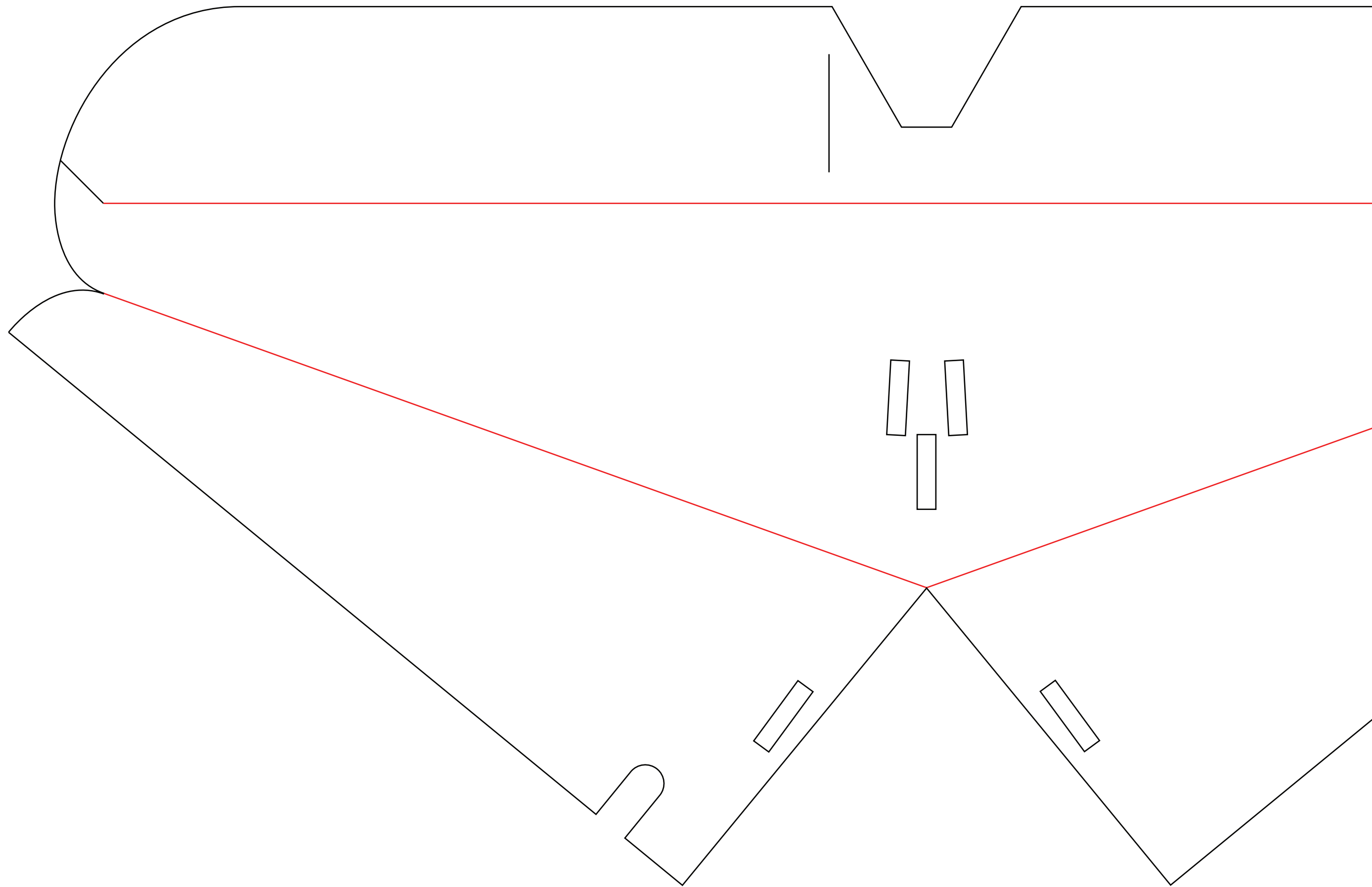

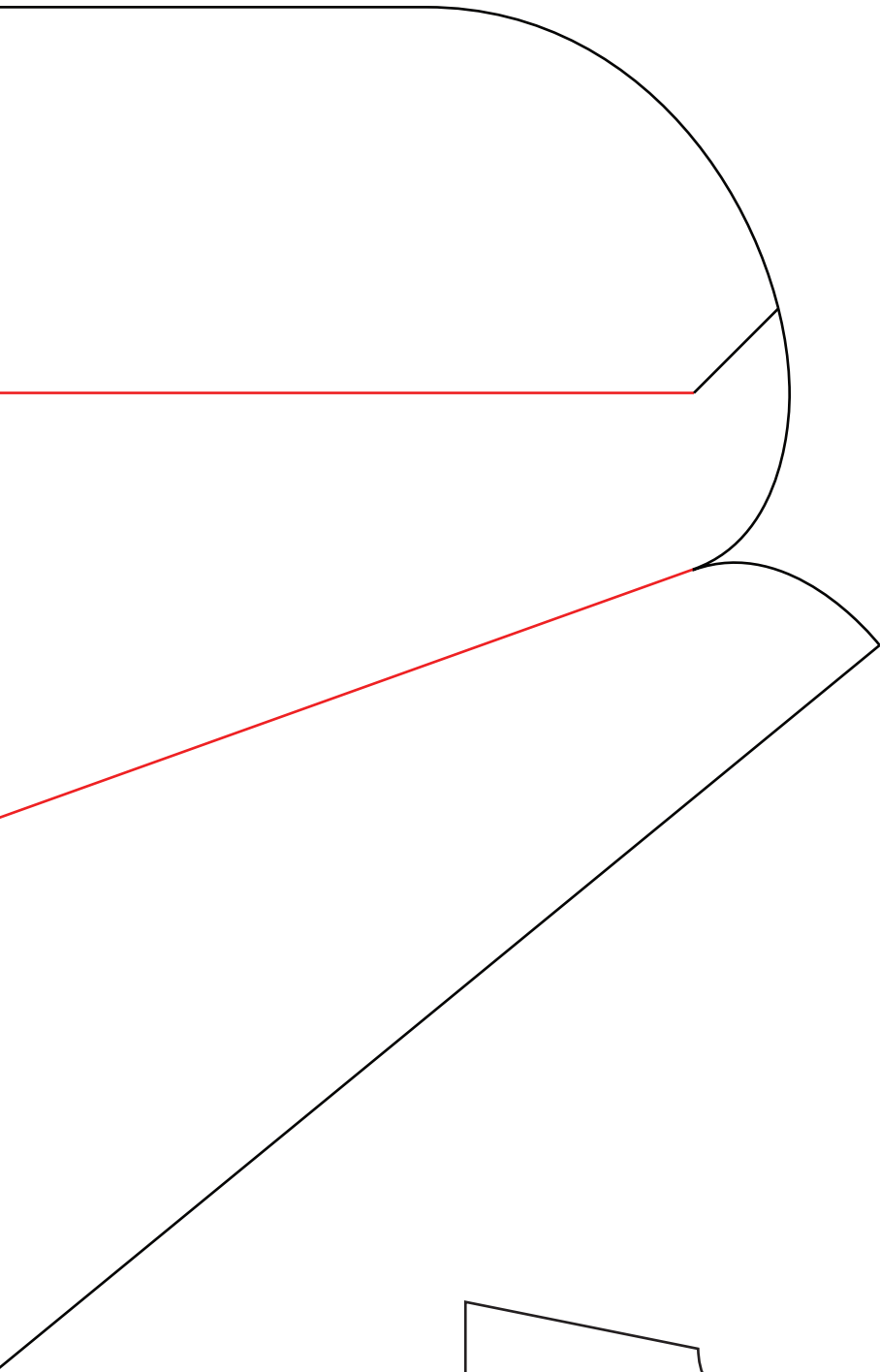

Canopy

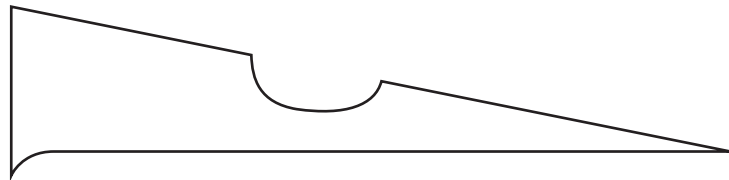
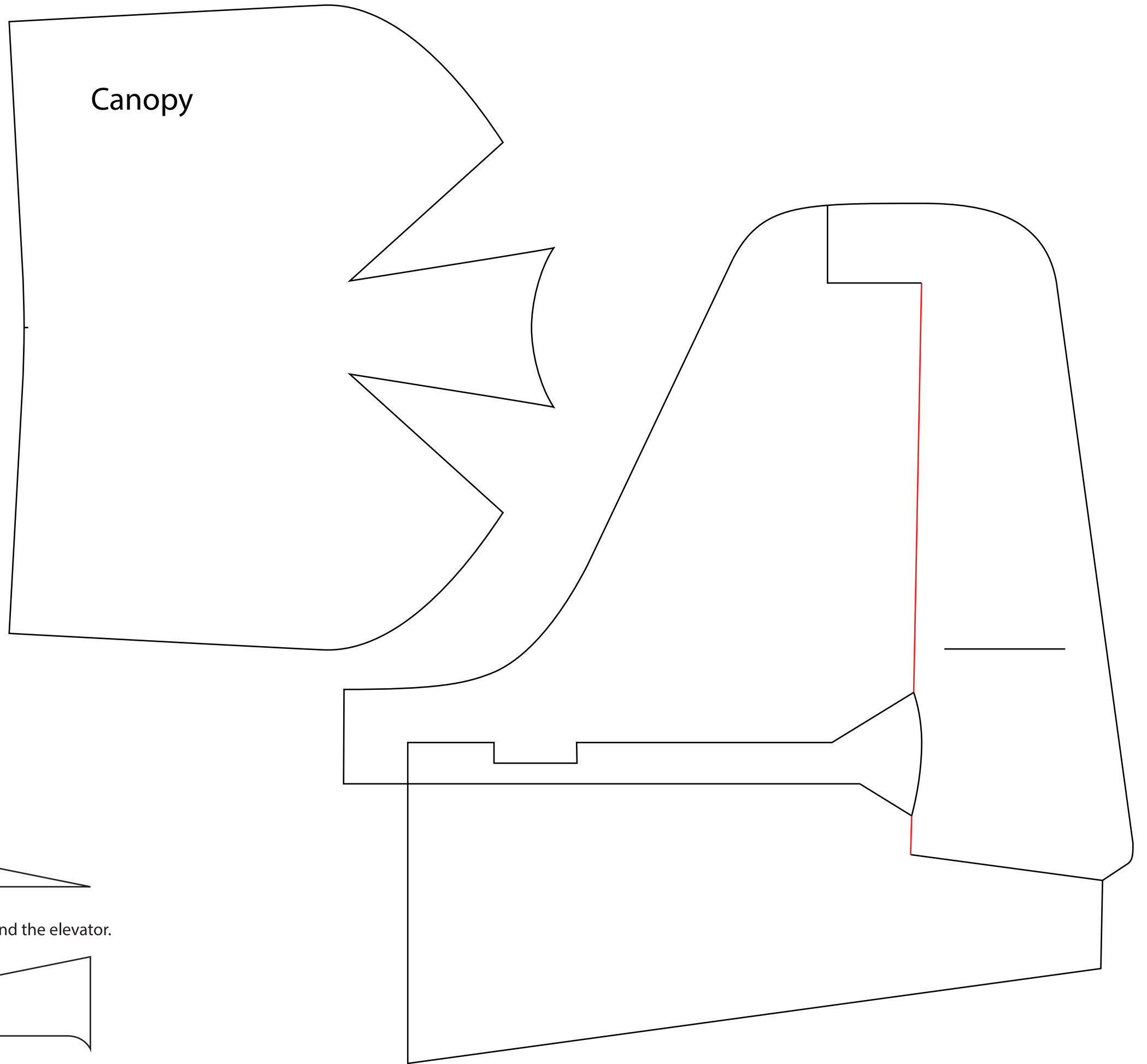

These are the fairings between the rudder and the elevator.



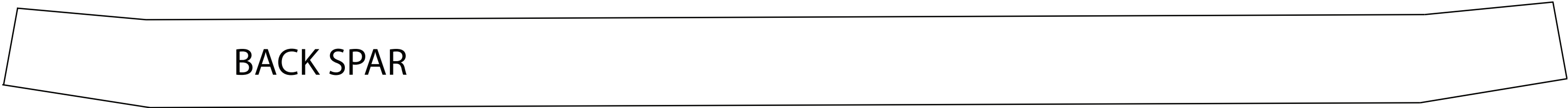
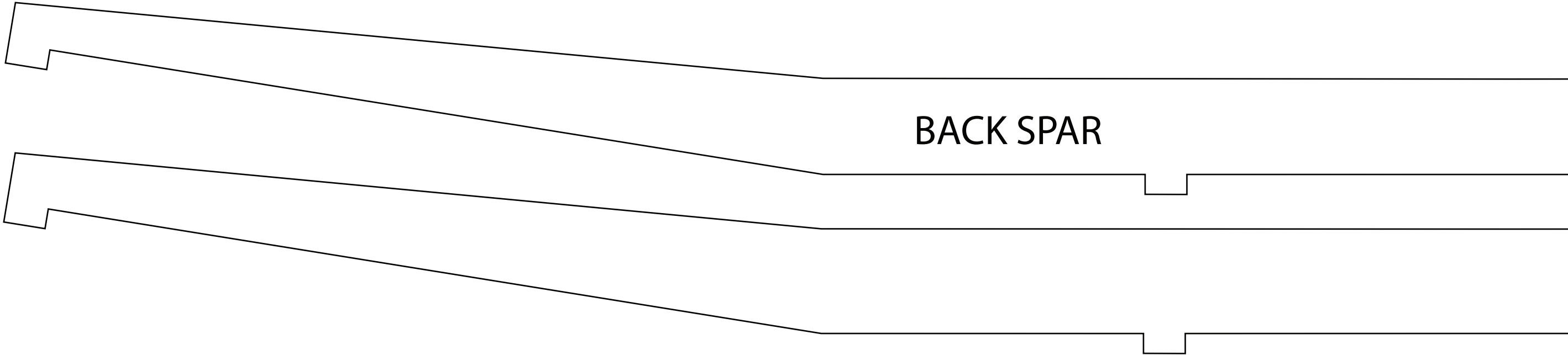

32"

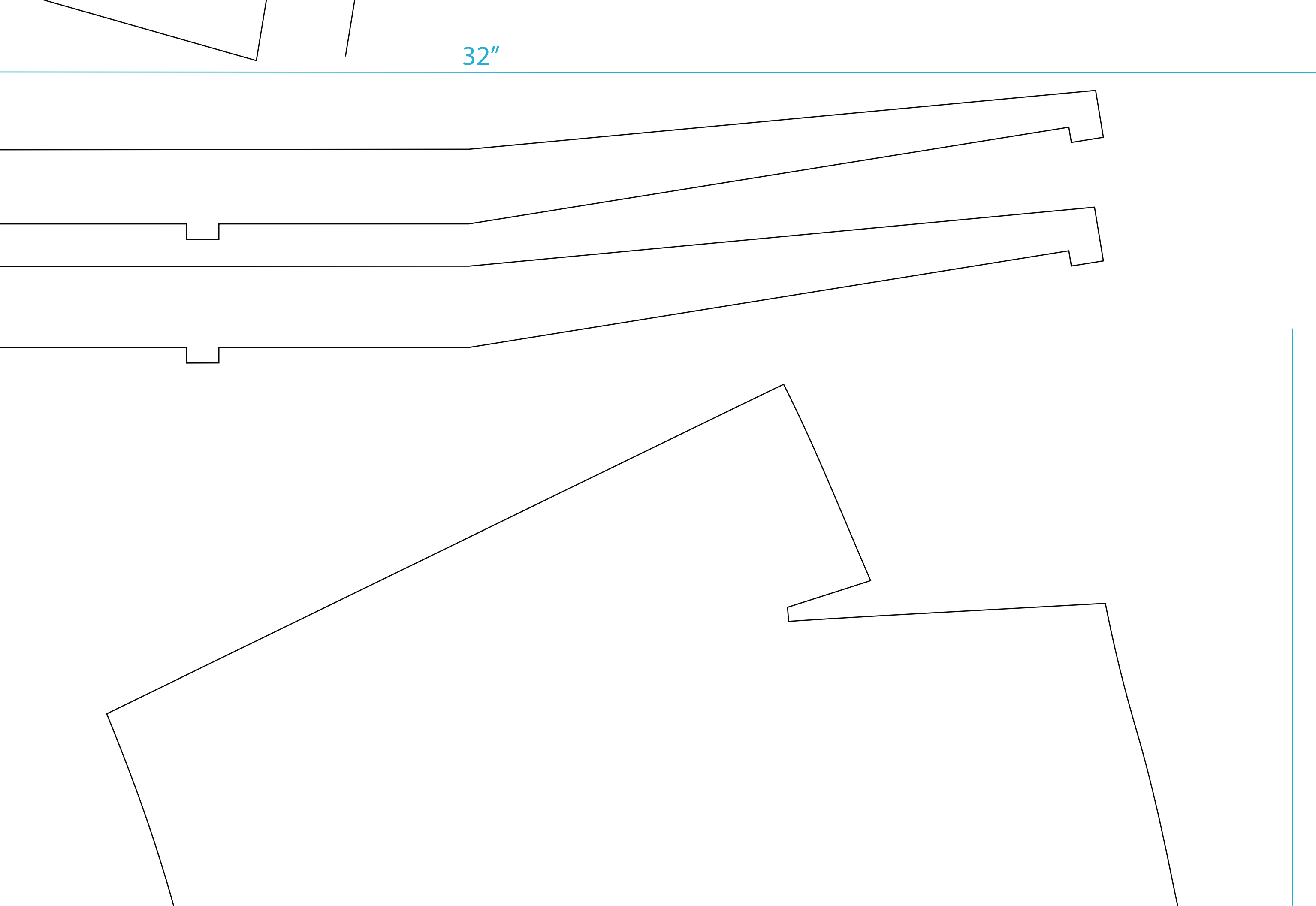

17"

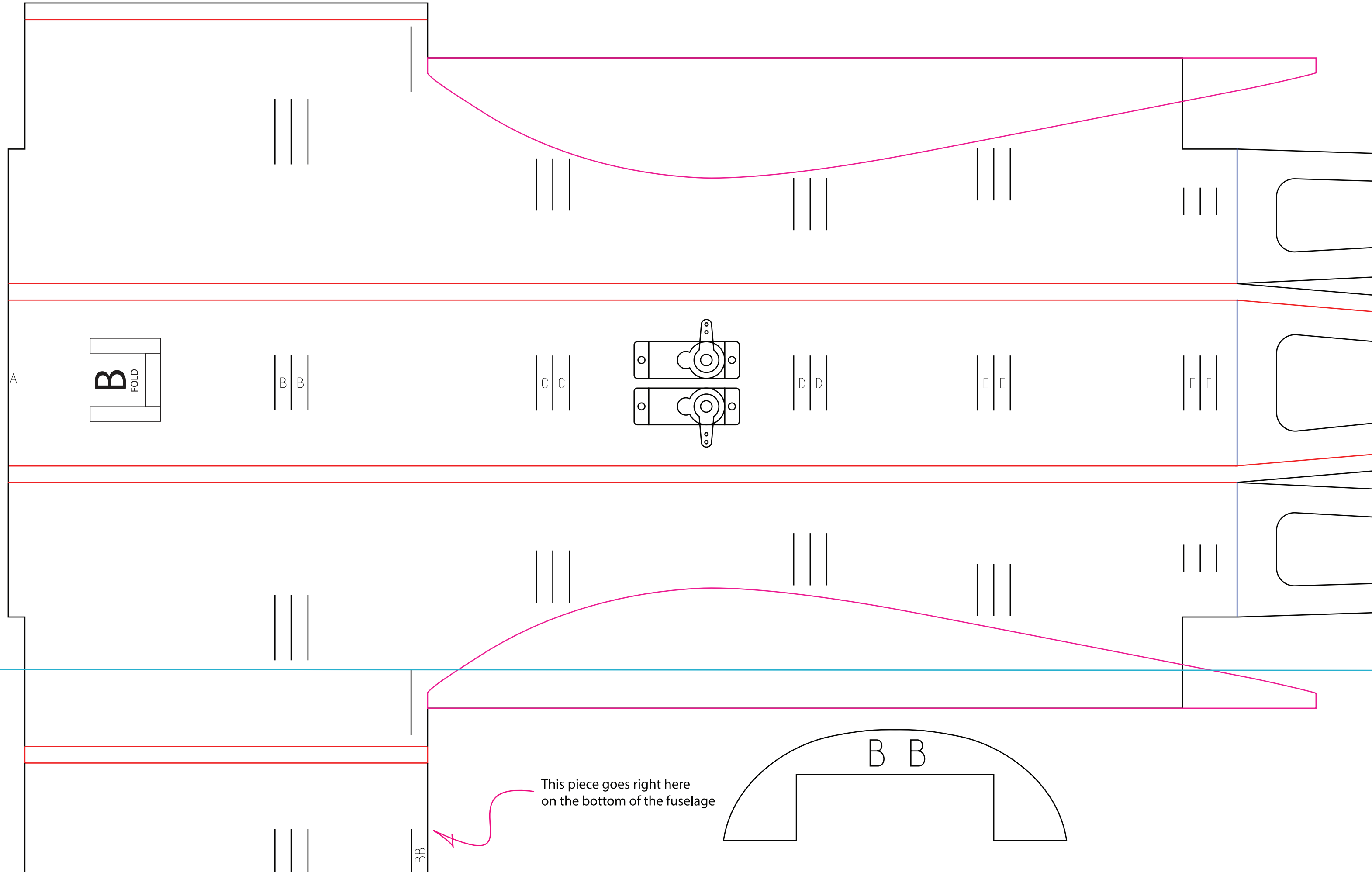

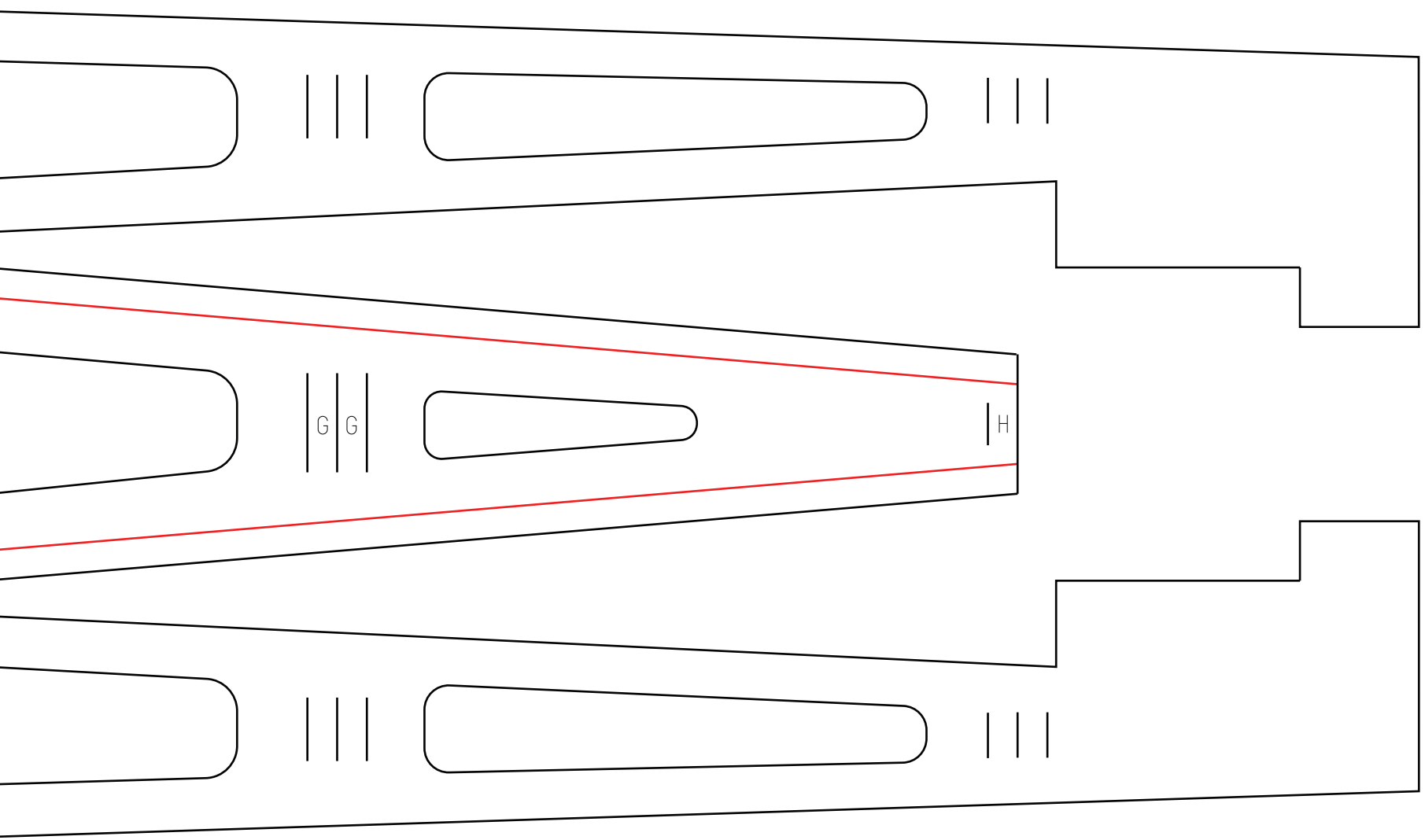

32"

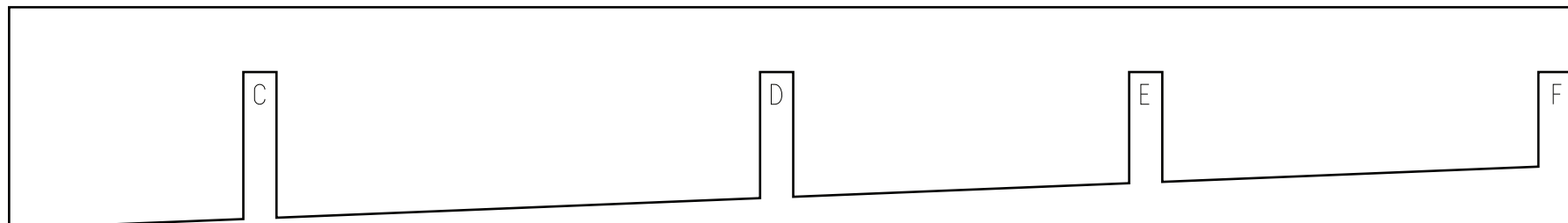

FF

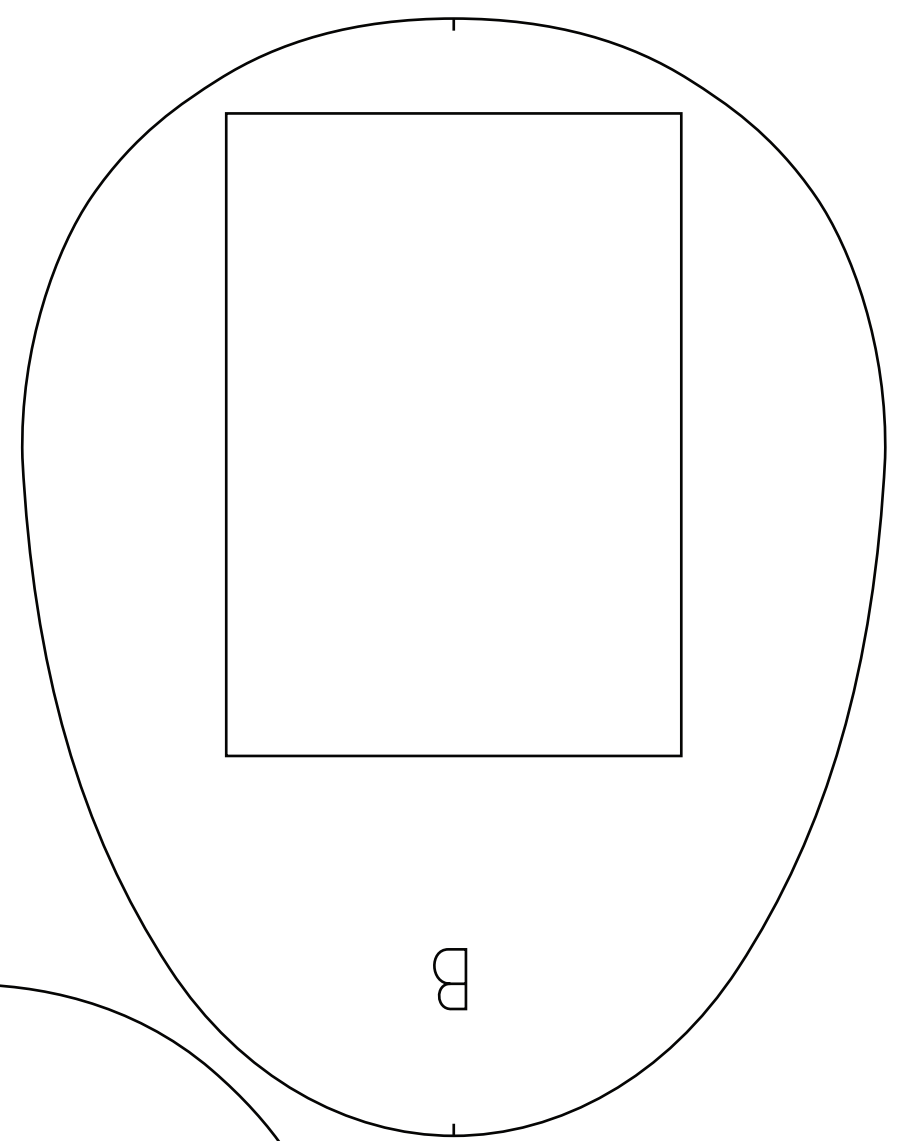
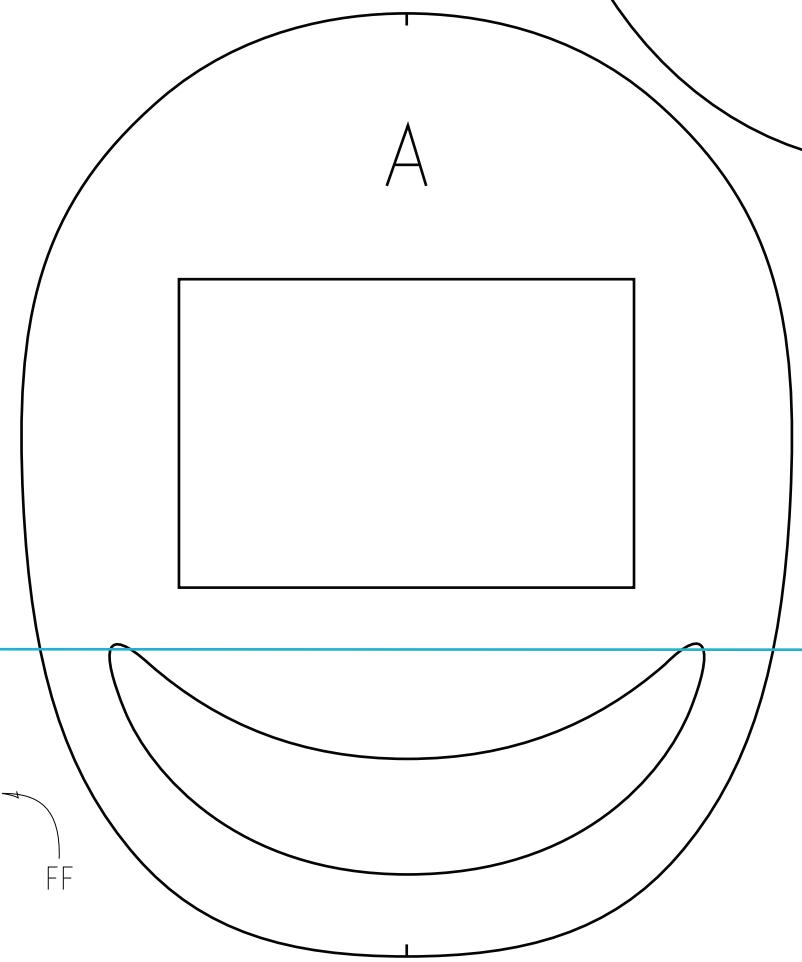

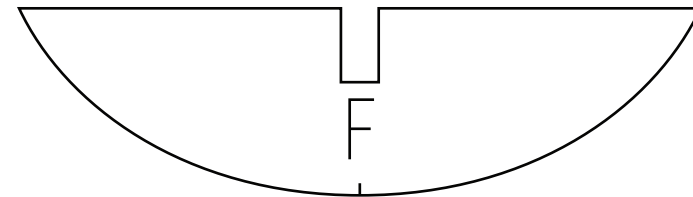
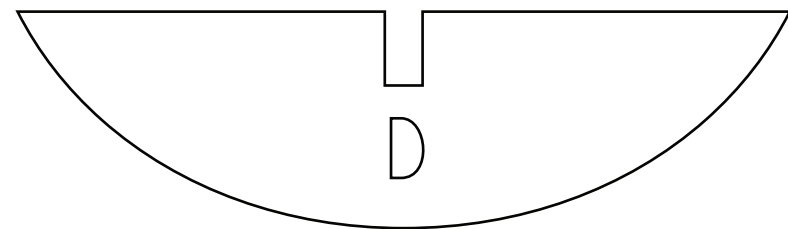
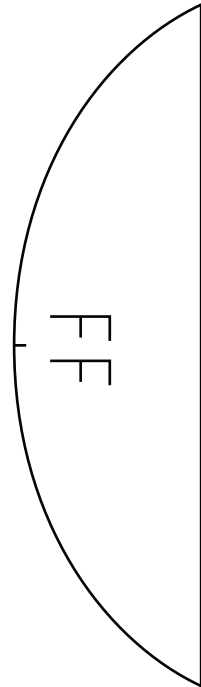
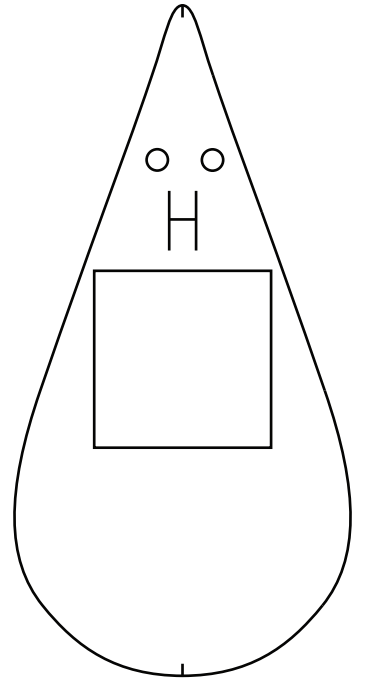
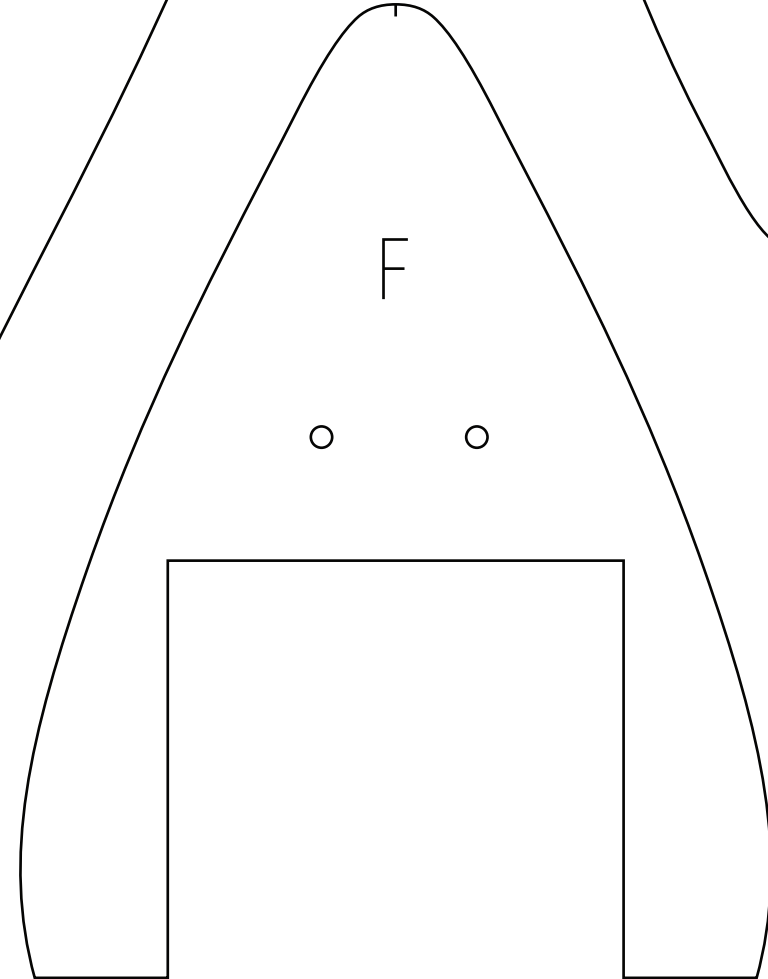
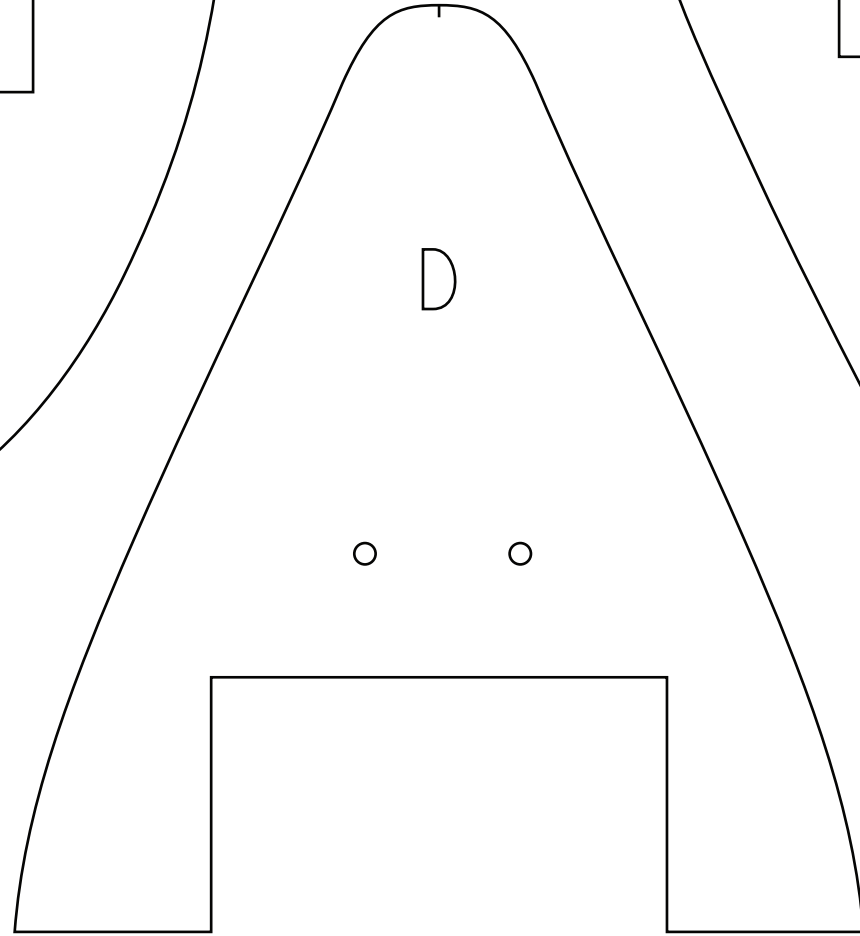
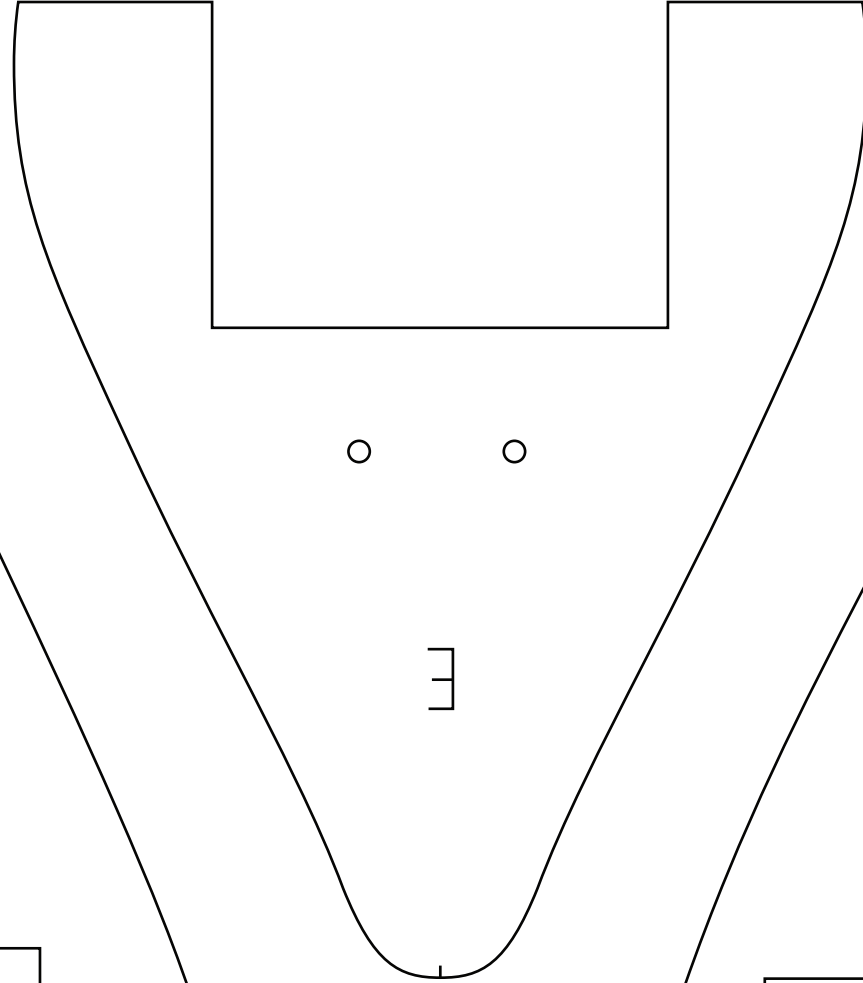
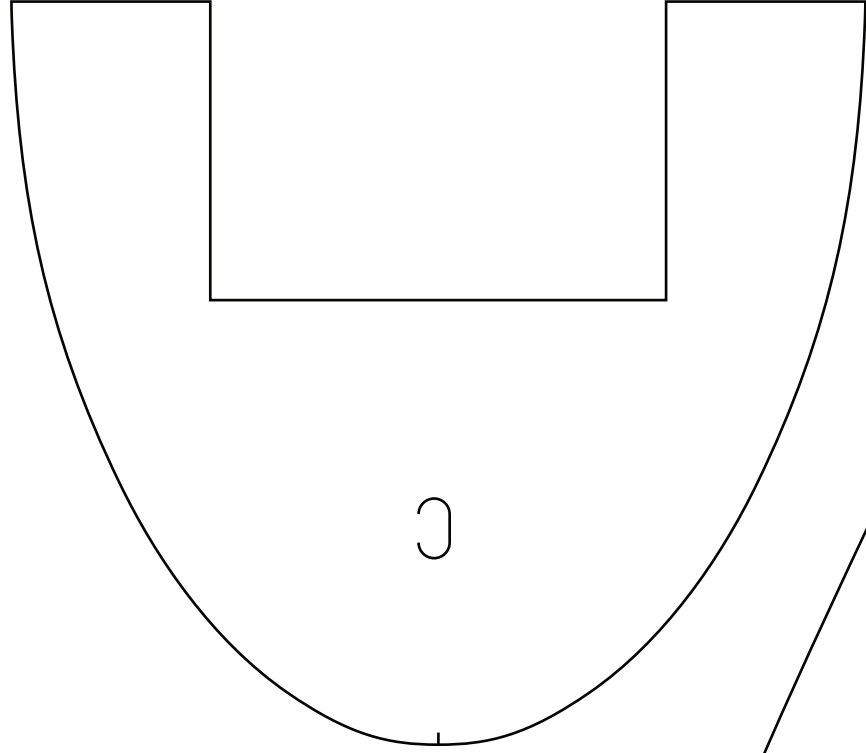
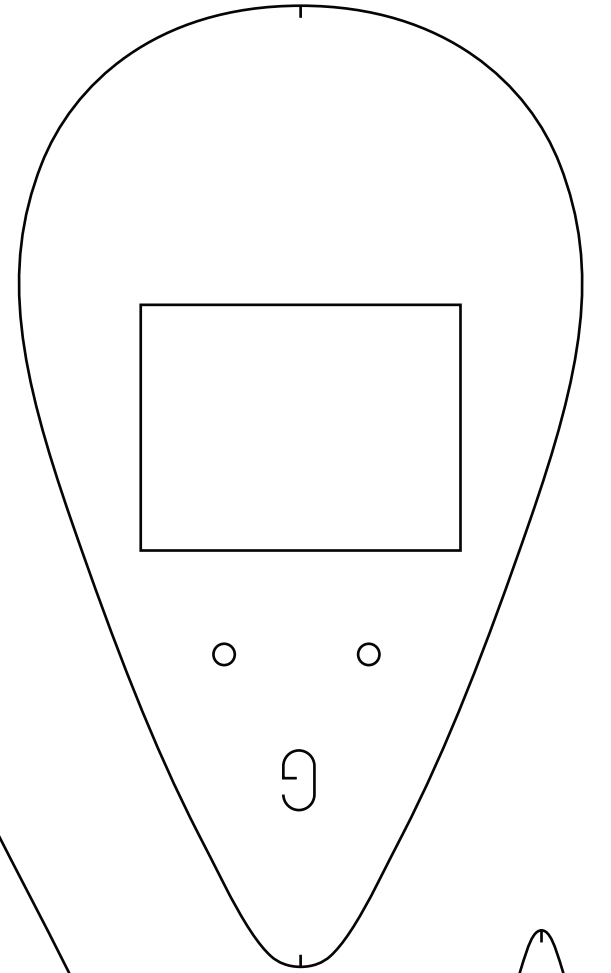
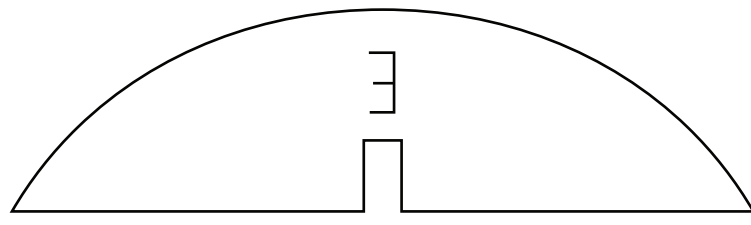
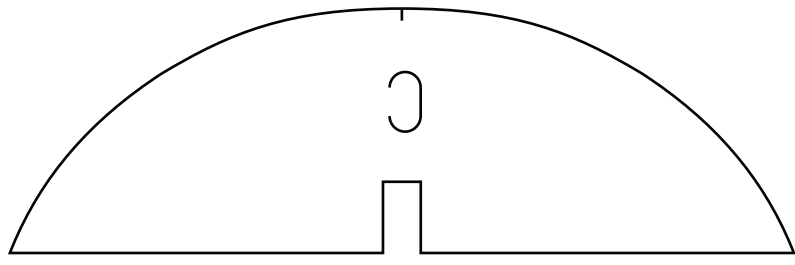

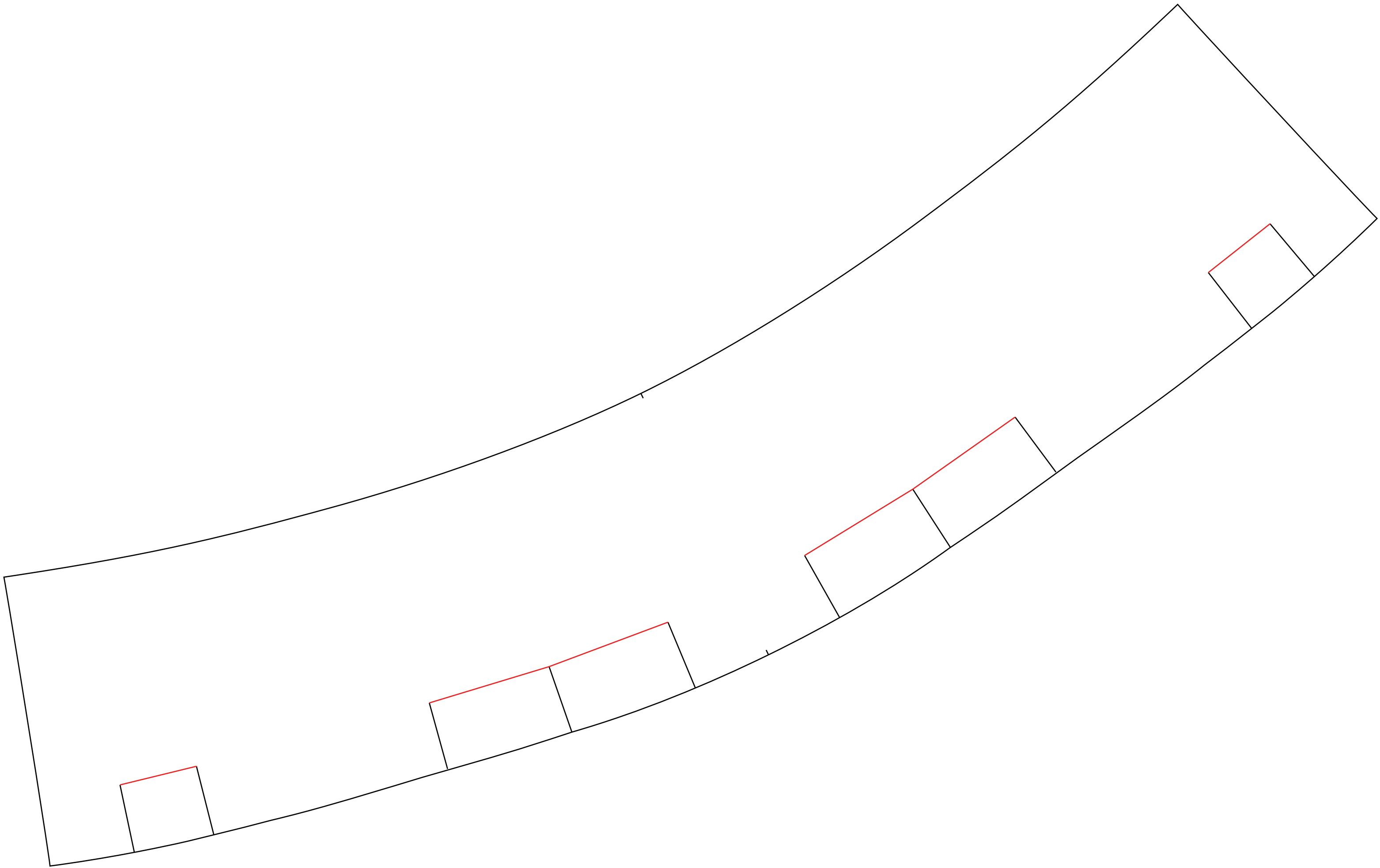

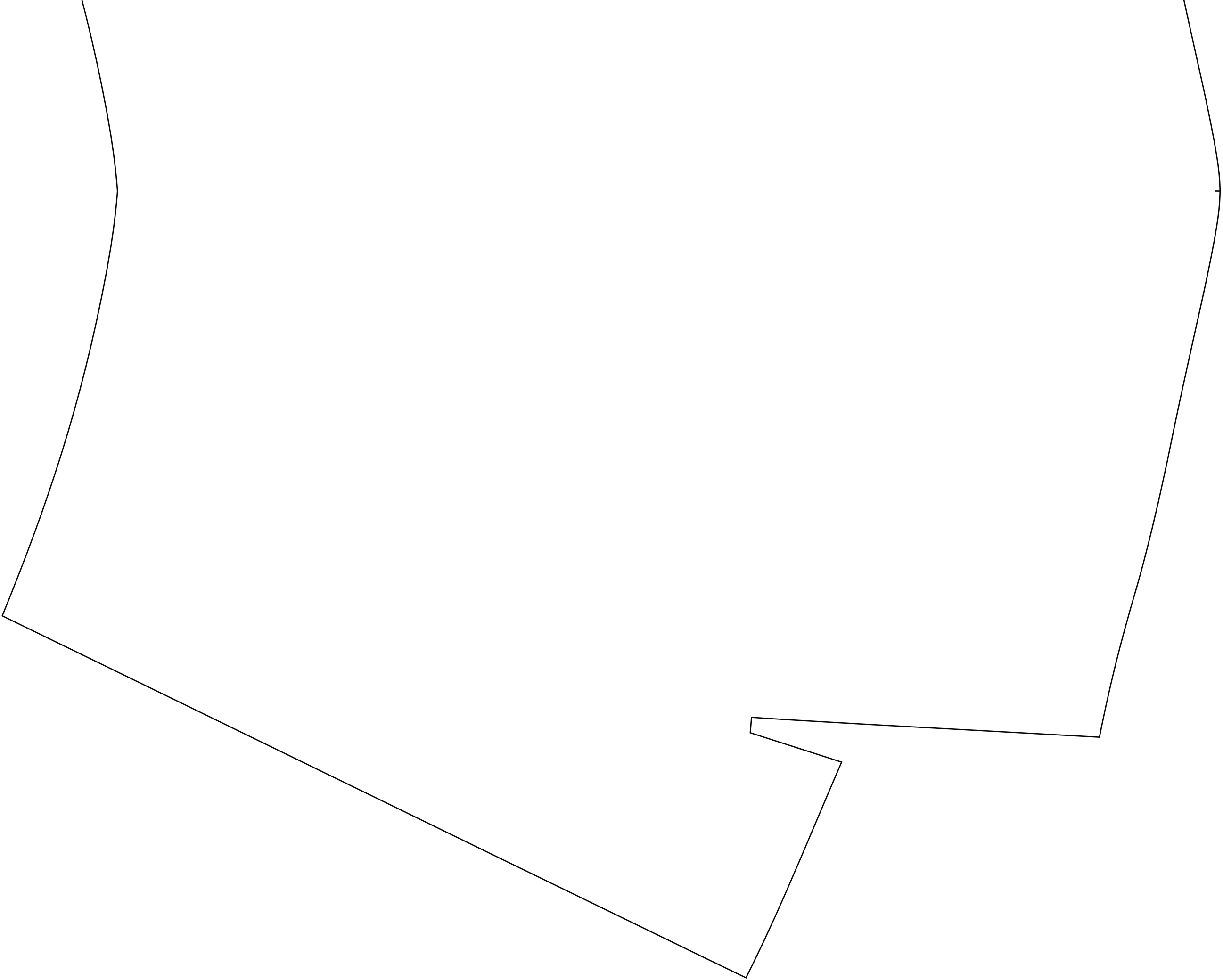

17"



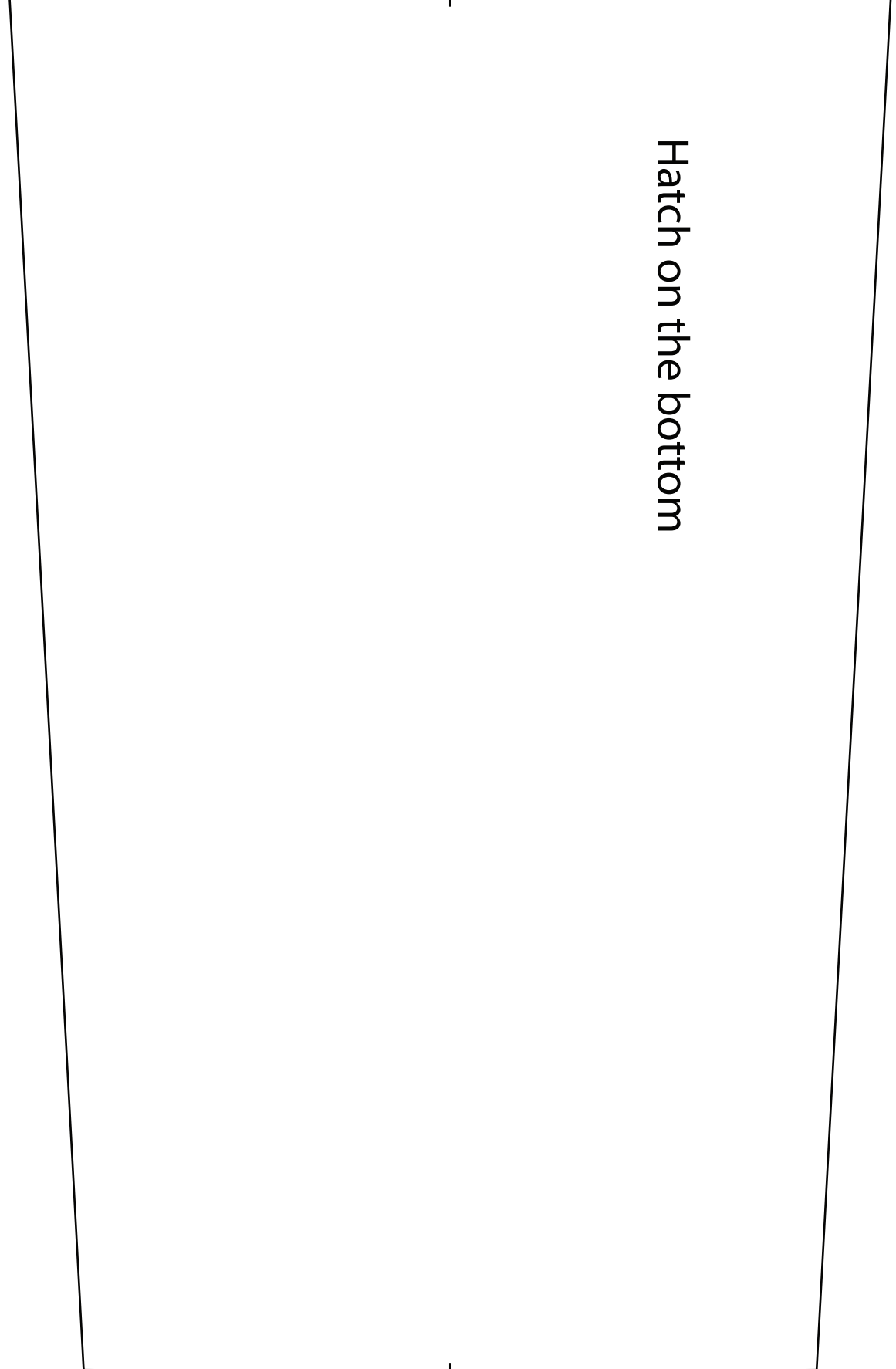
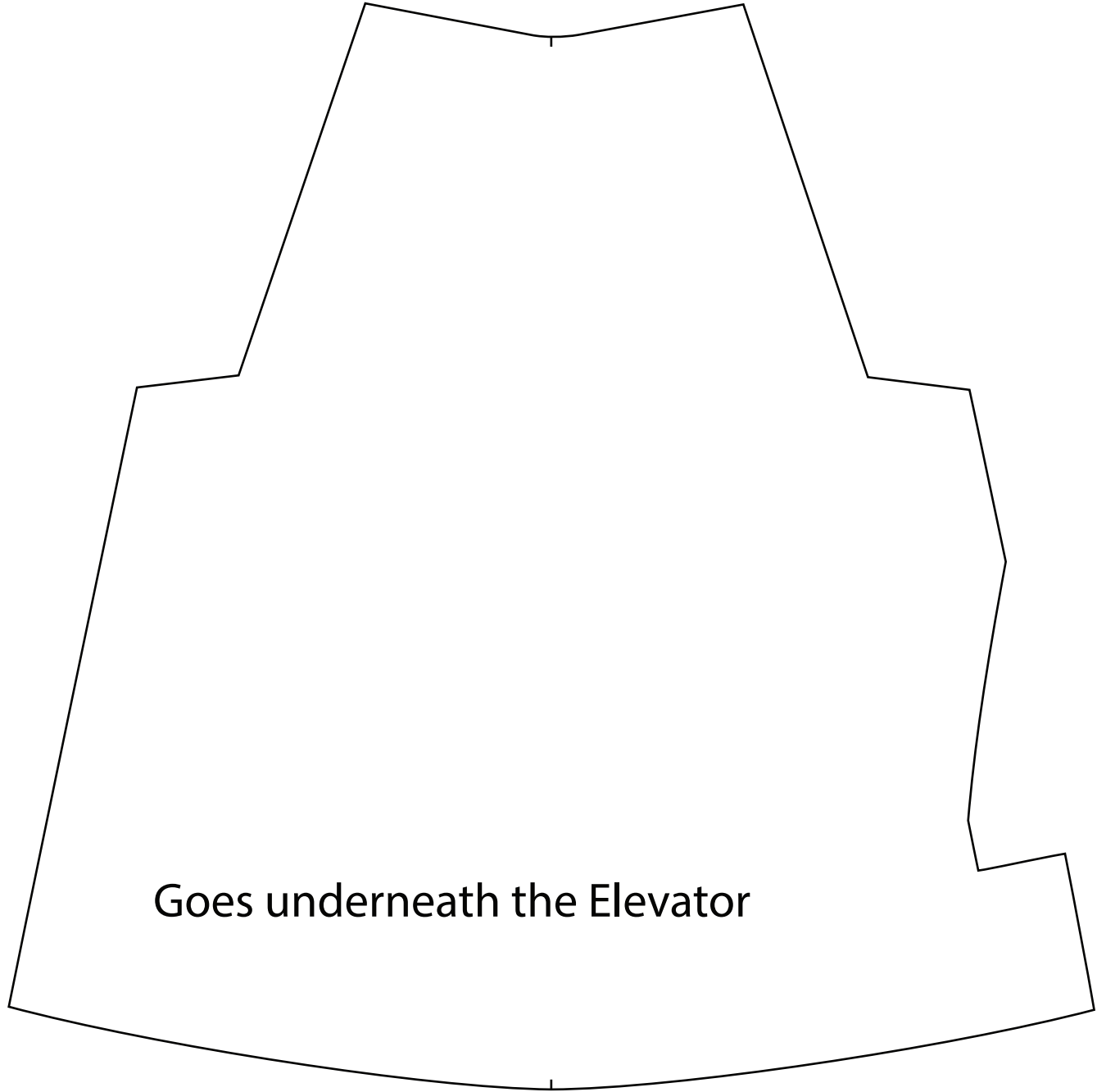

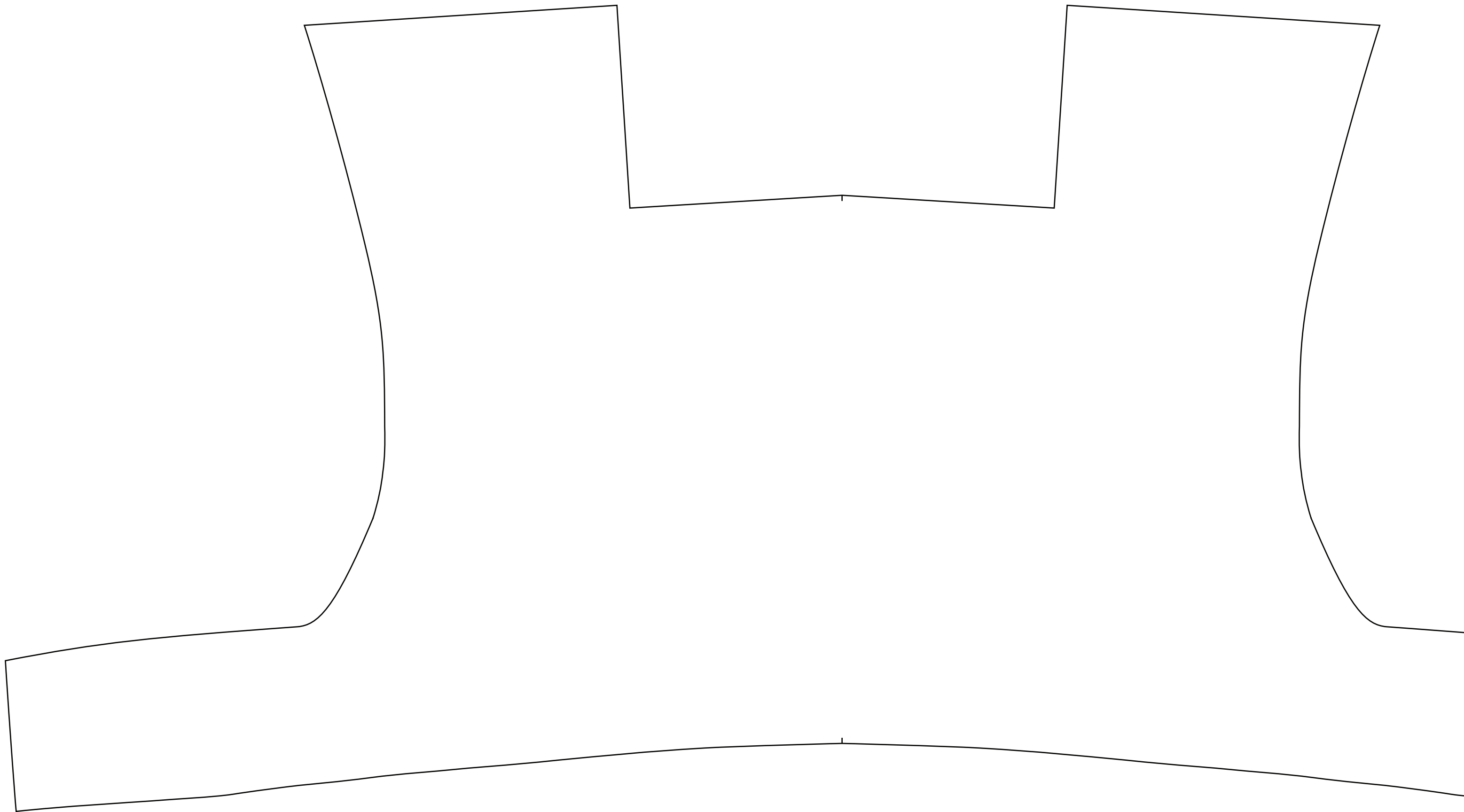

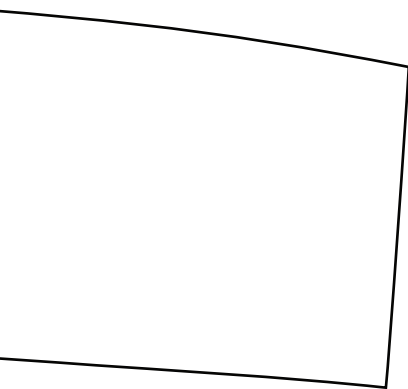
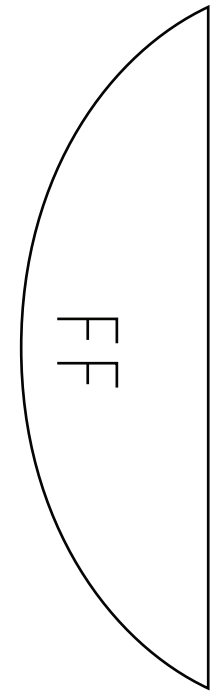
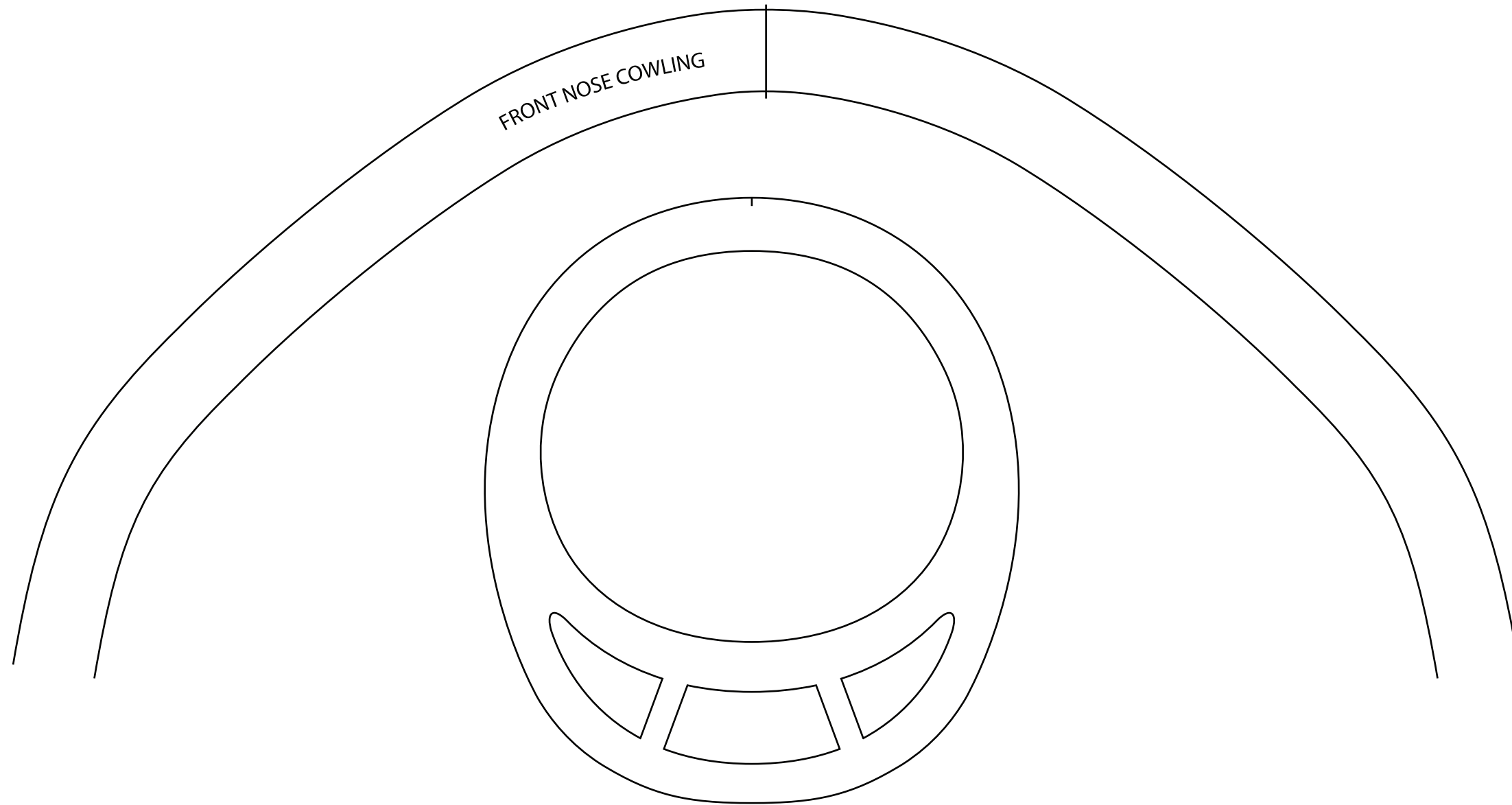

32"