

Flop these Nacelle pieces for the other side.

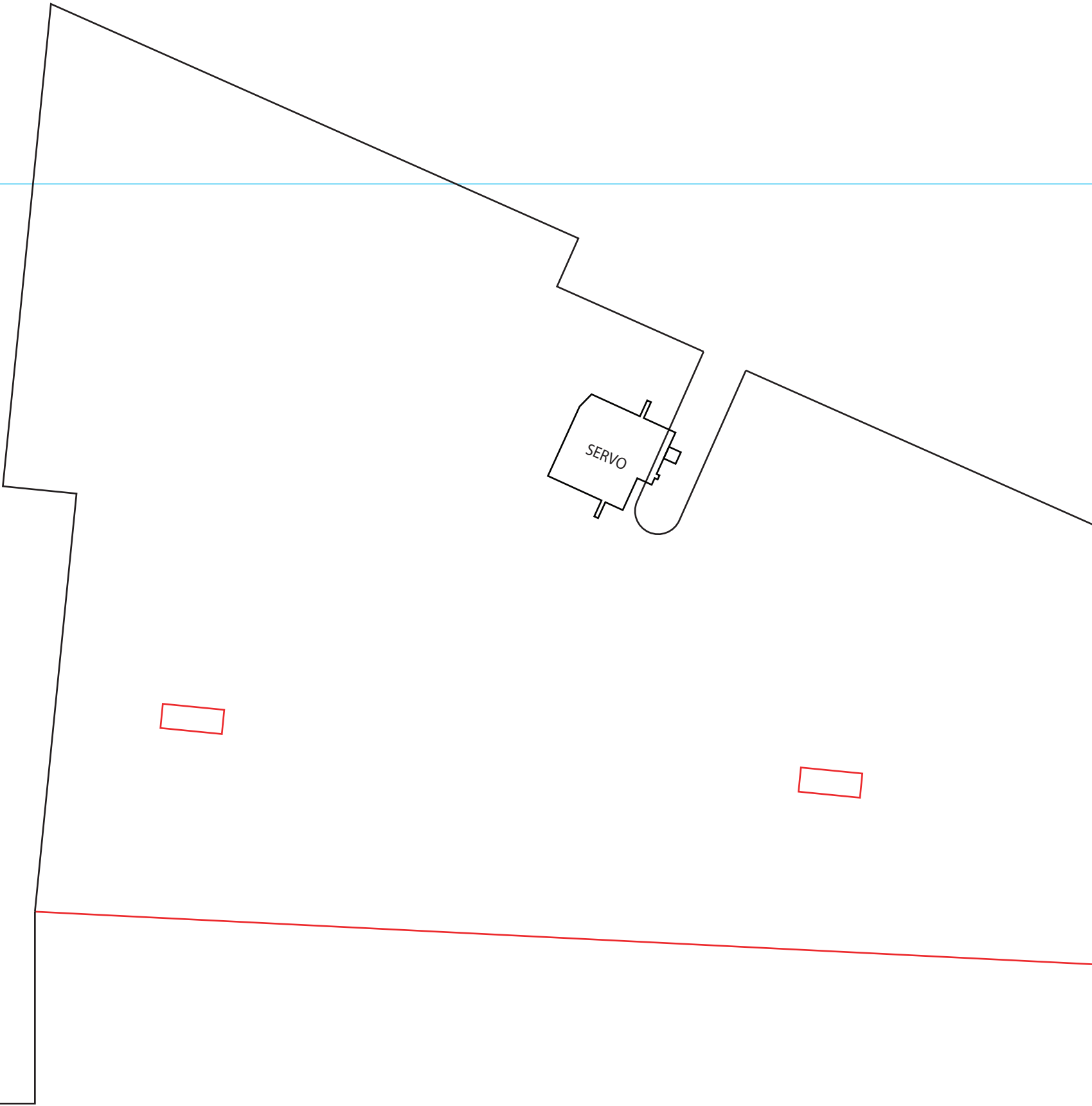

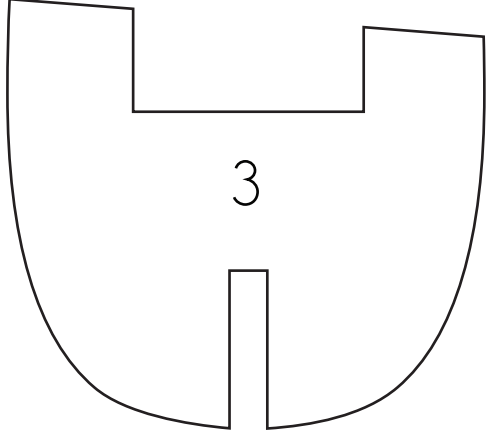
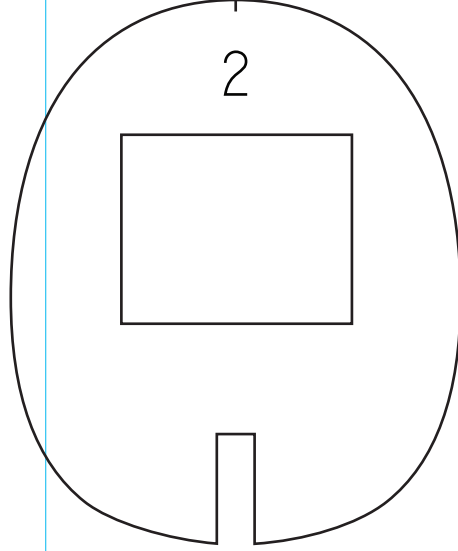
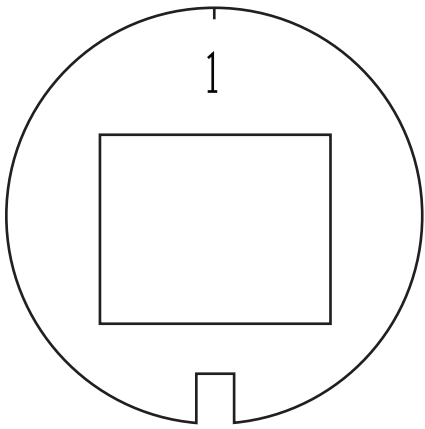
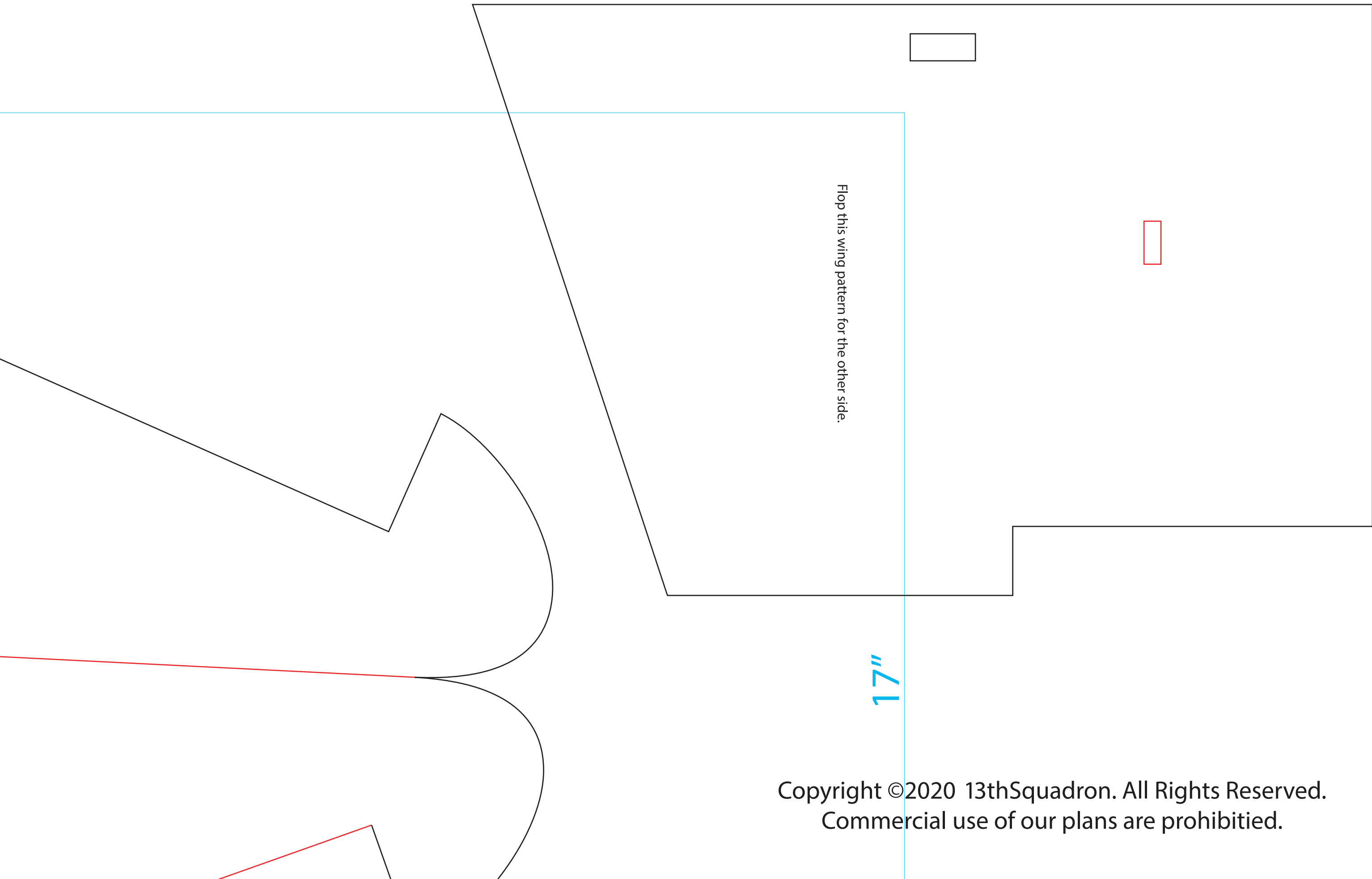

Flop this wing pattern for the other side.

17"

Copyright ©2020 13thSquadron. All Rights Reserved.  
Commercial use of our plans are prohibited.

DO NOT GLUE DOWN "A" FORMER AND "B" FORMER!  
BECAUSE IT HAS A REMOVEABLE NOSE FOR THE HATCH.

28"

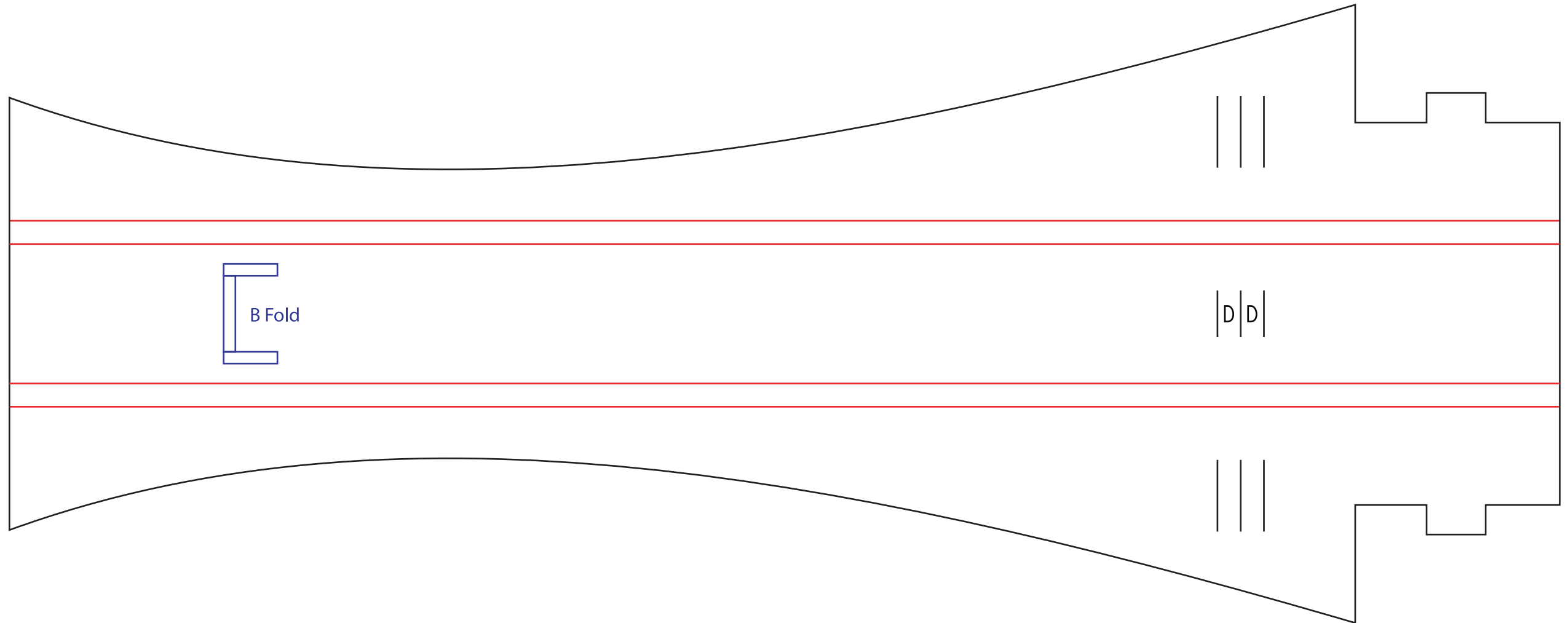
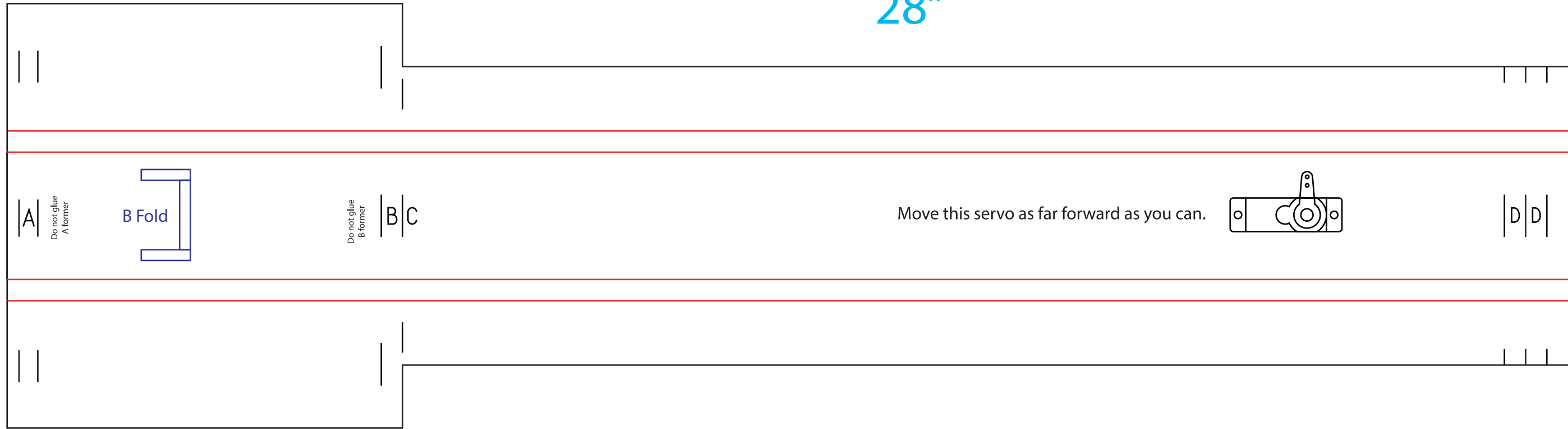

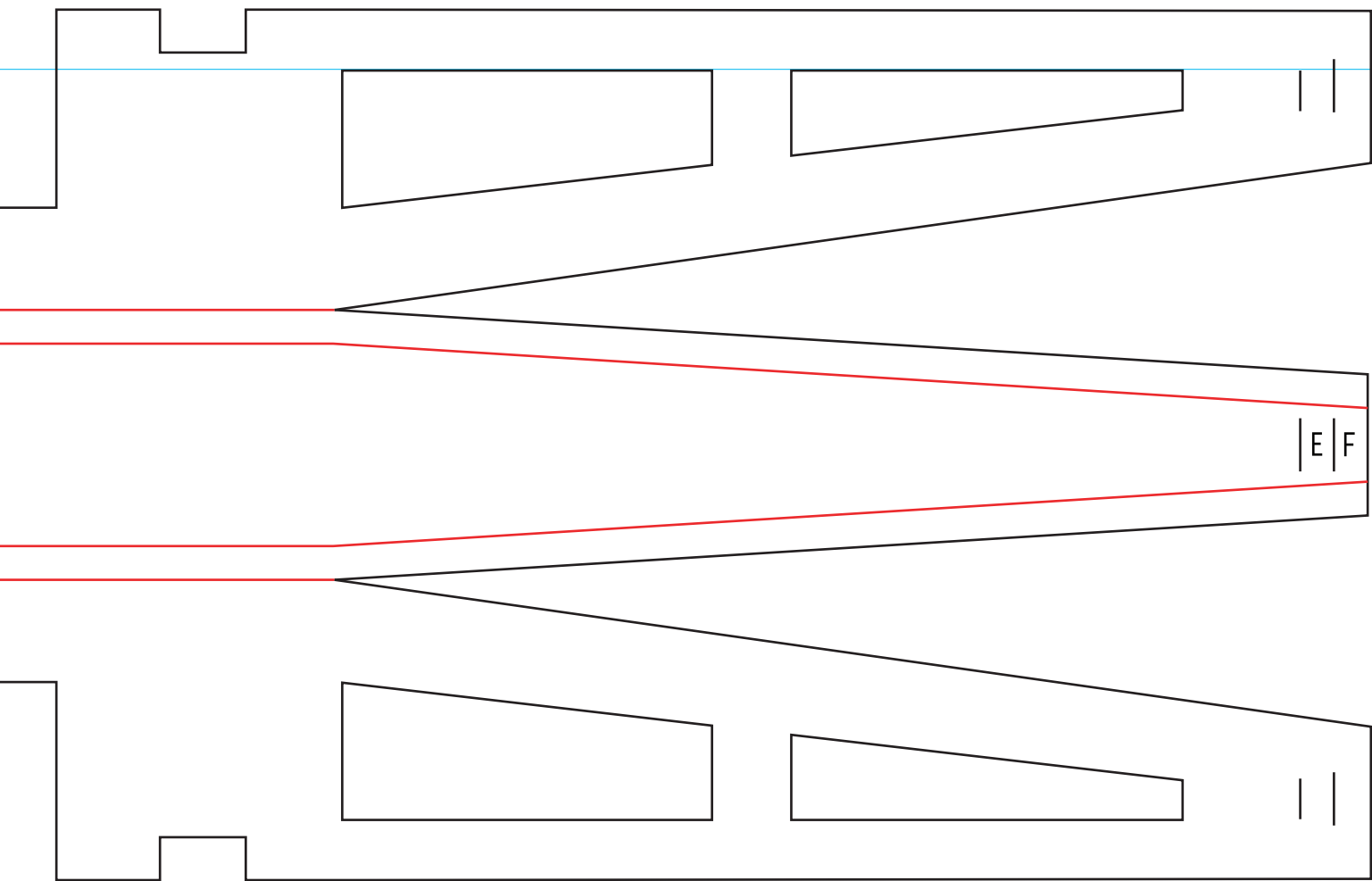

|E|F

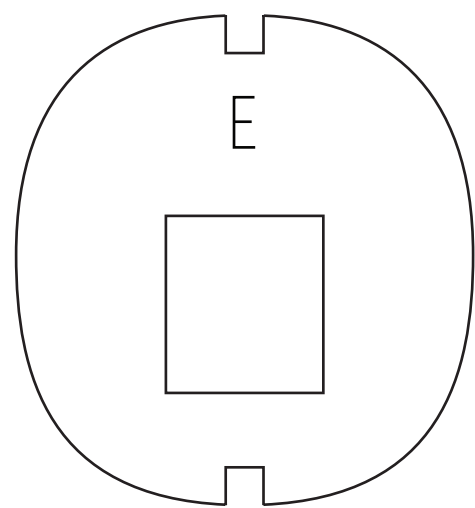

E

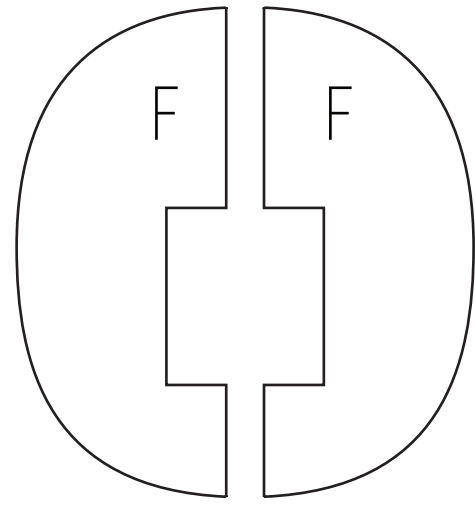

F

F

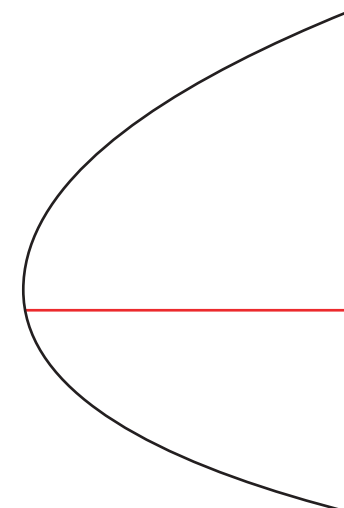
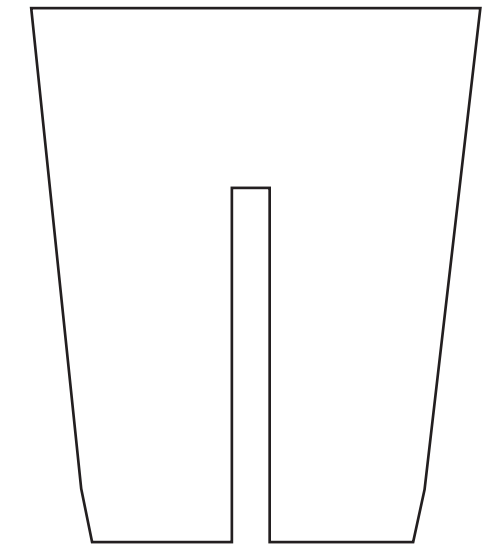
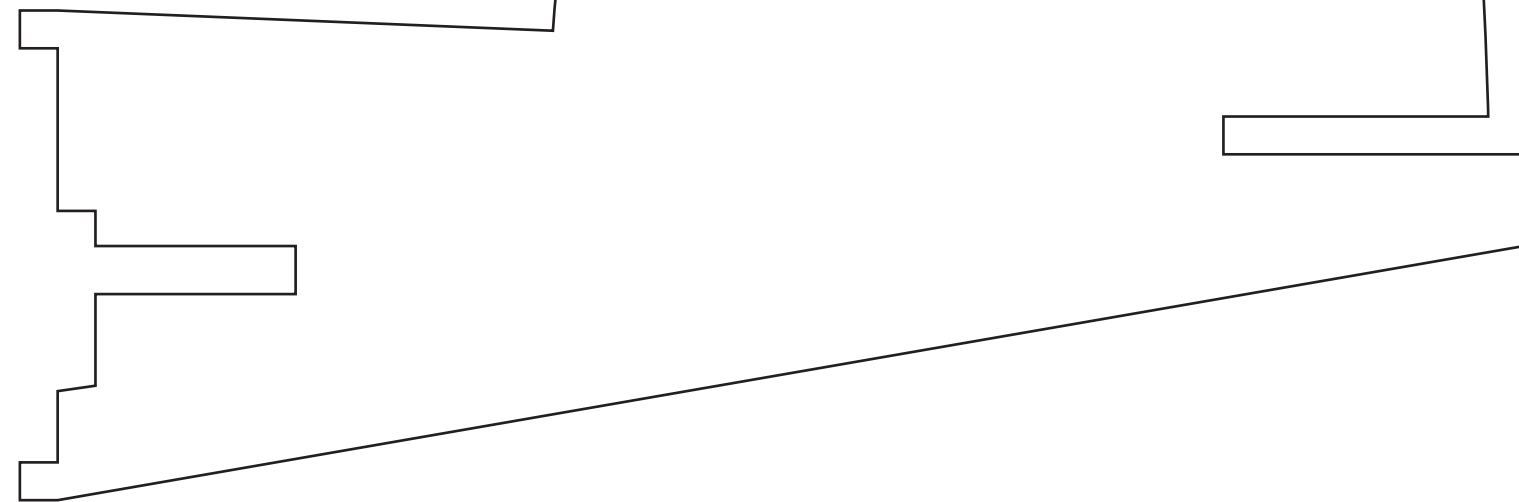

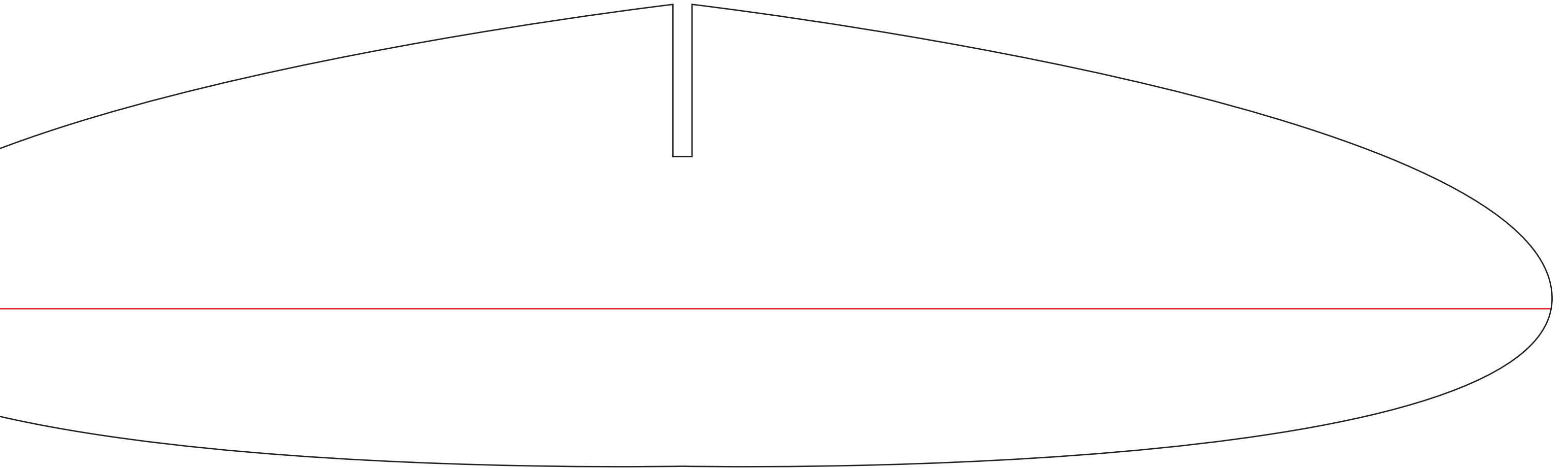
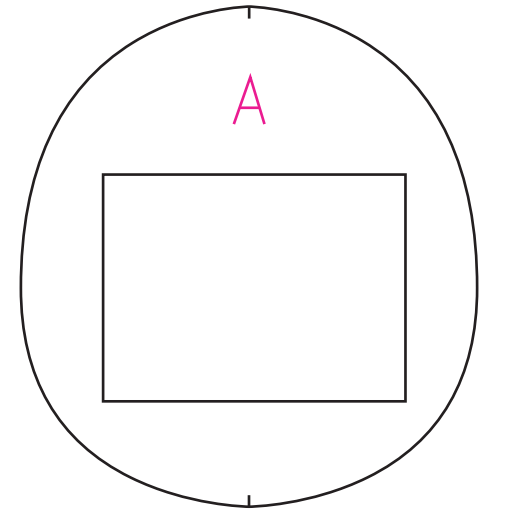
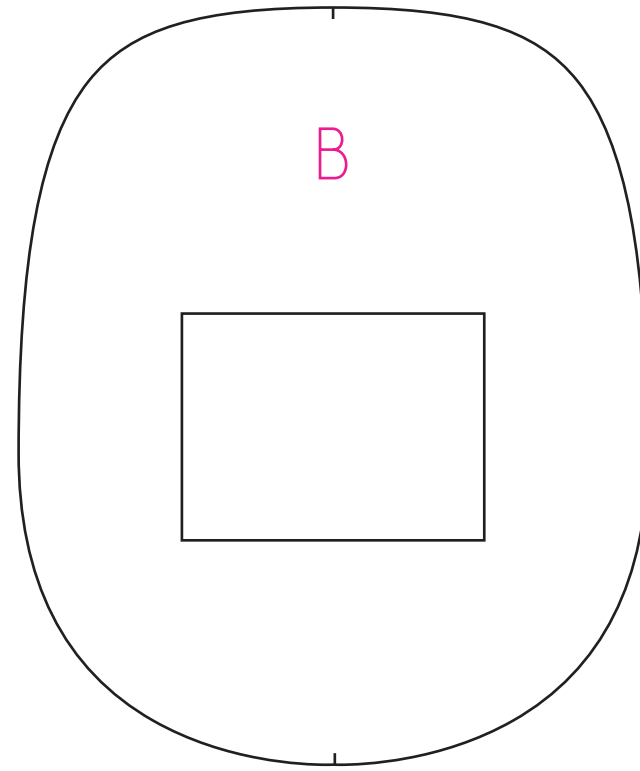
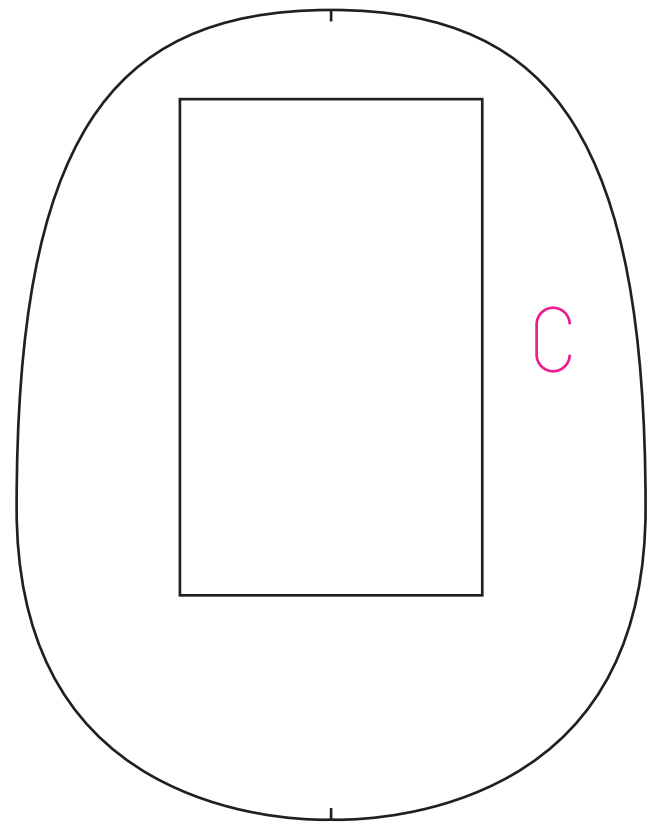
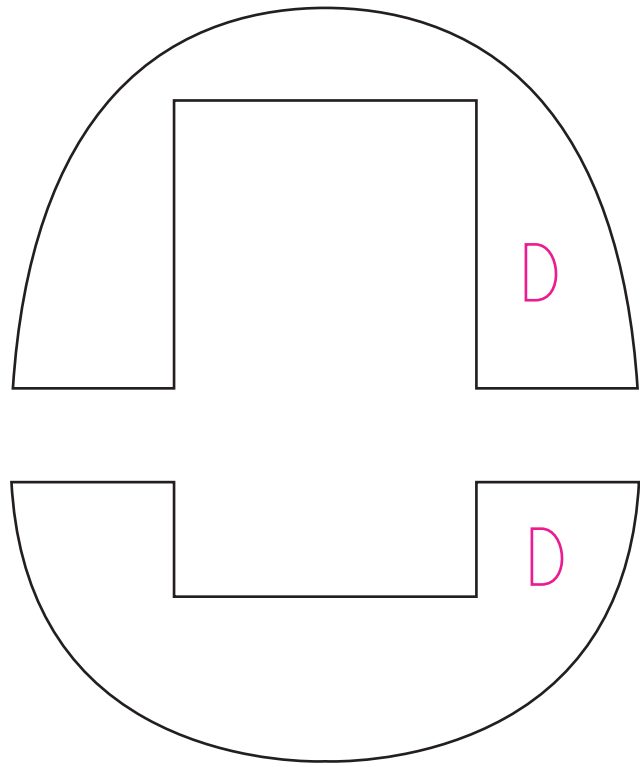

Flop this wing pattern for the other side.

25"

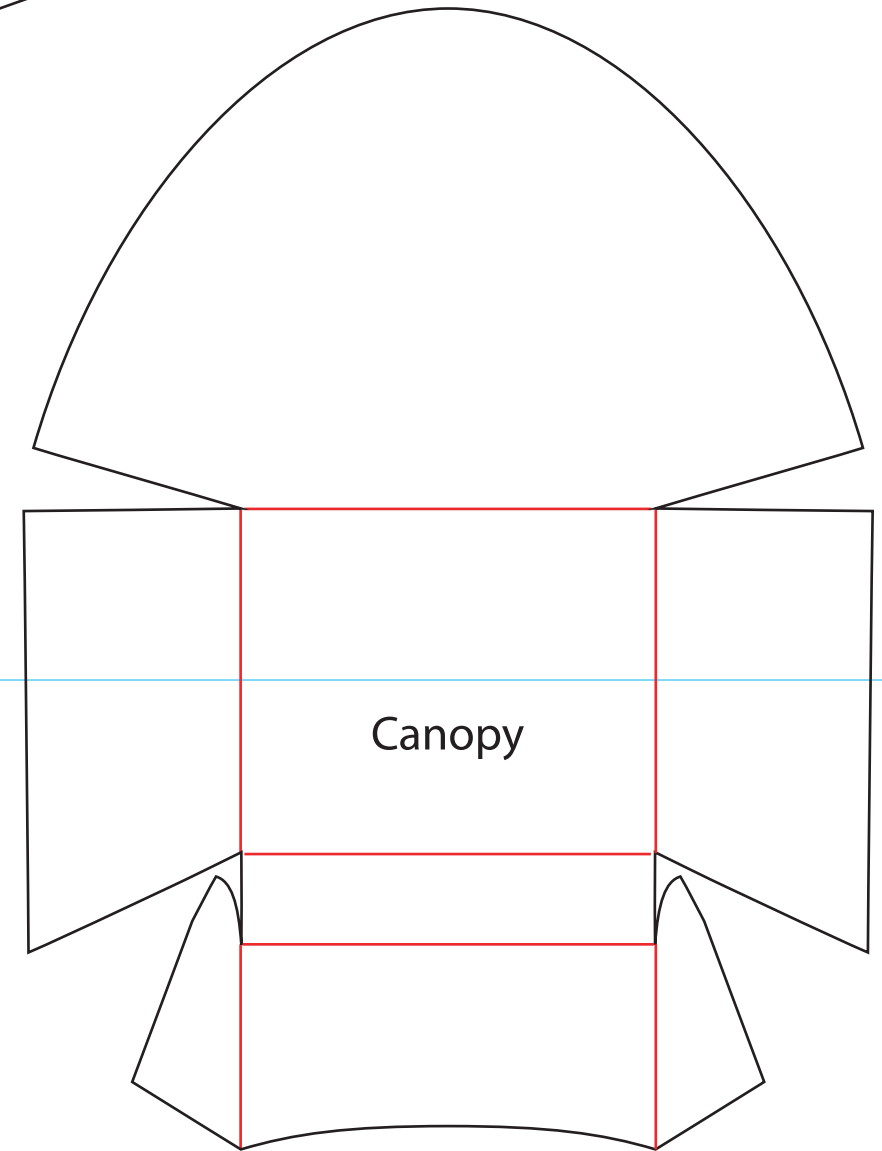

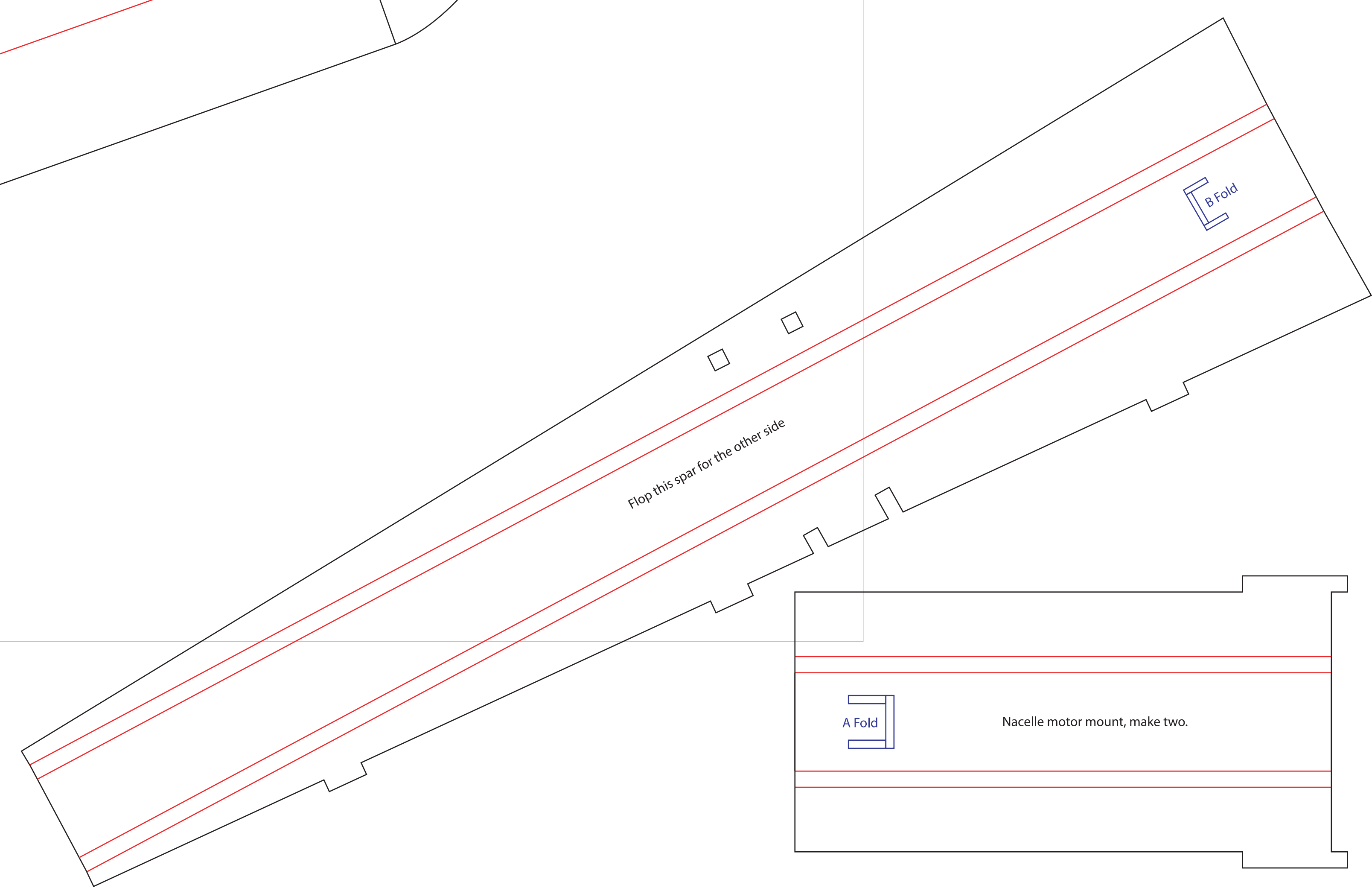

Flop this spar for the other side

B Fold

A Fold

Nacelle motor mount, make two.

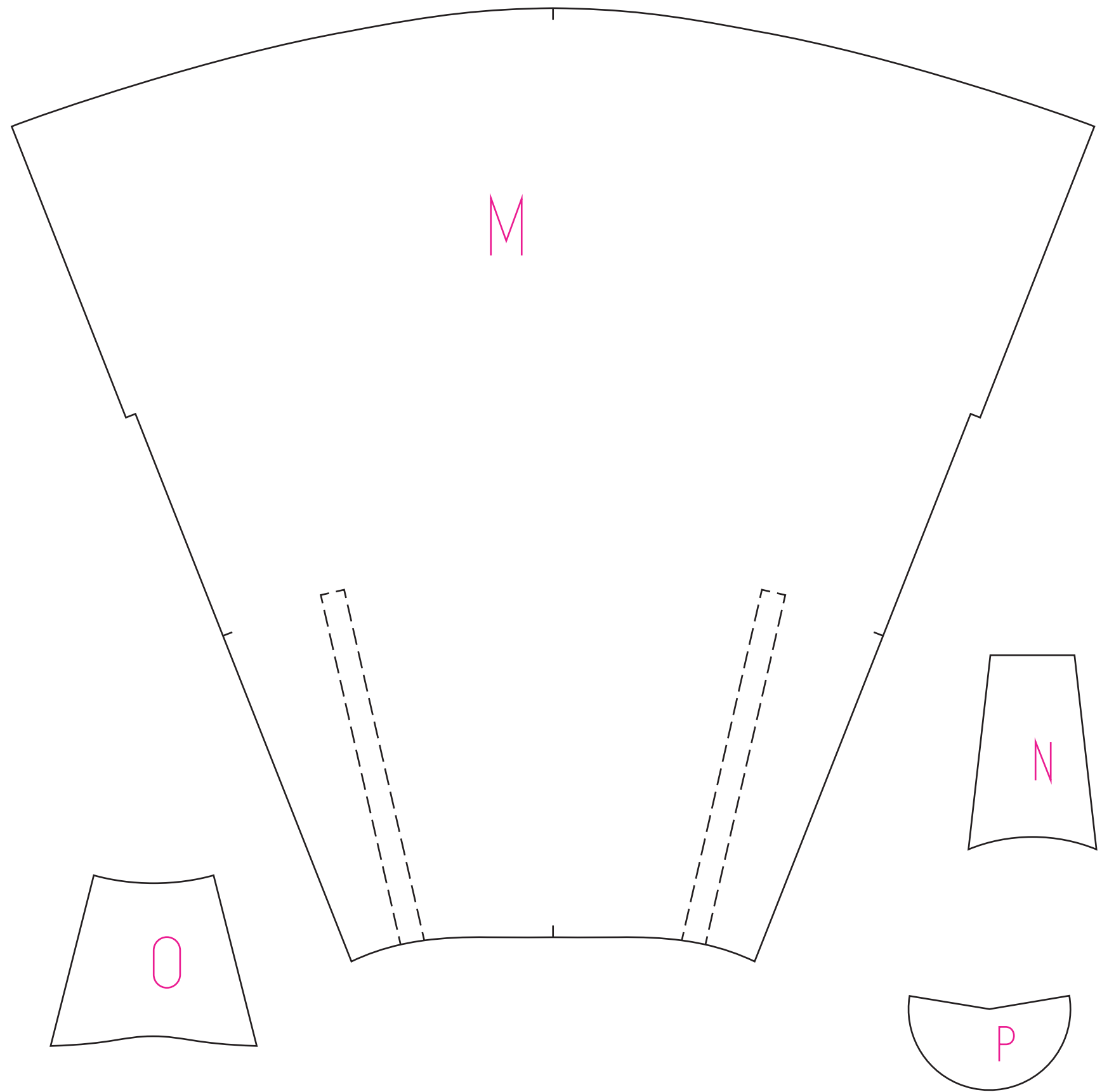
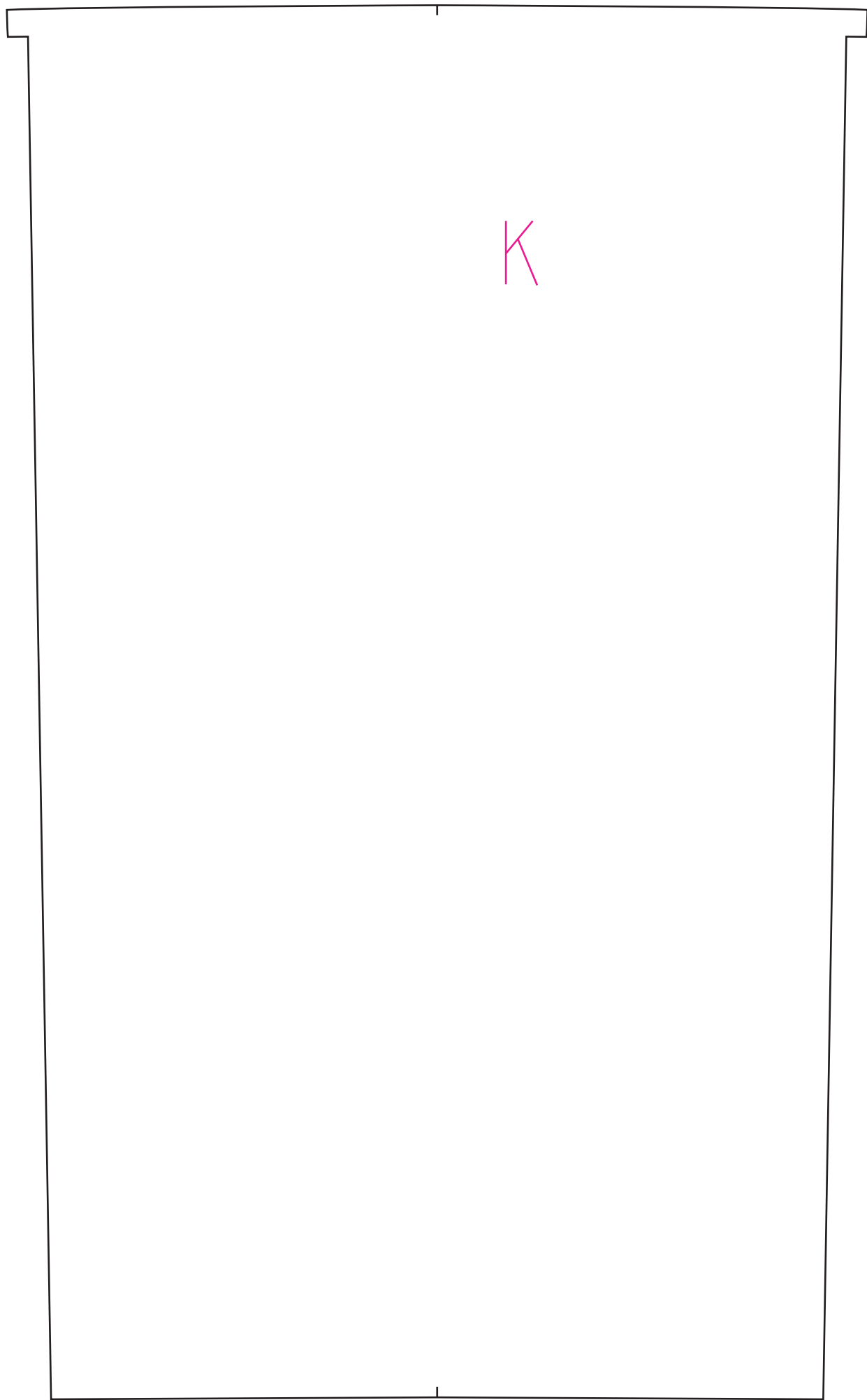



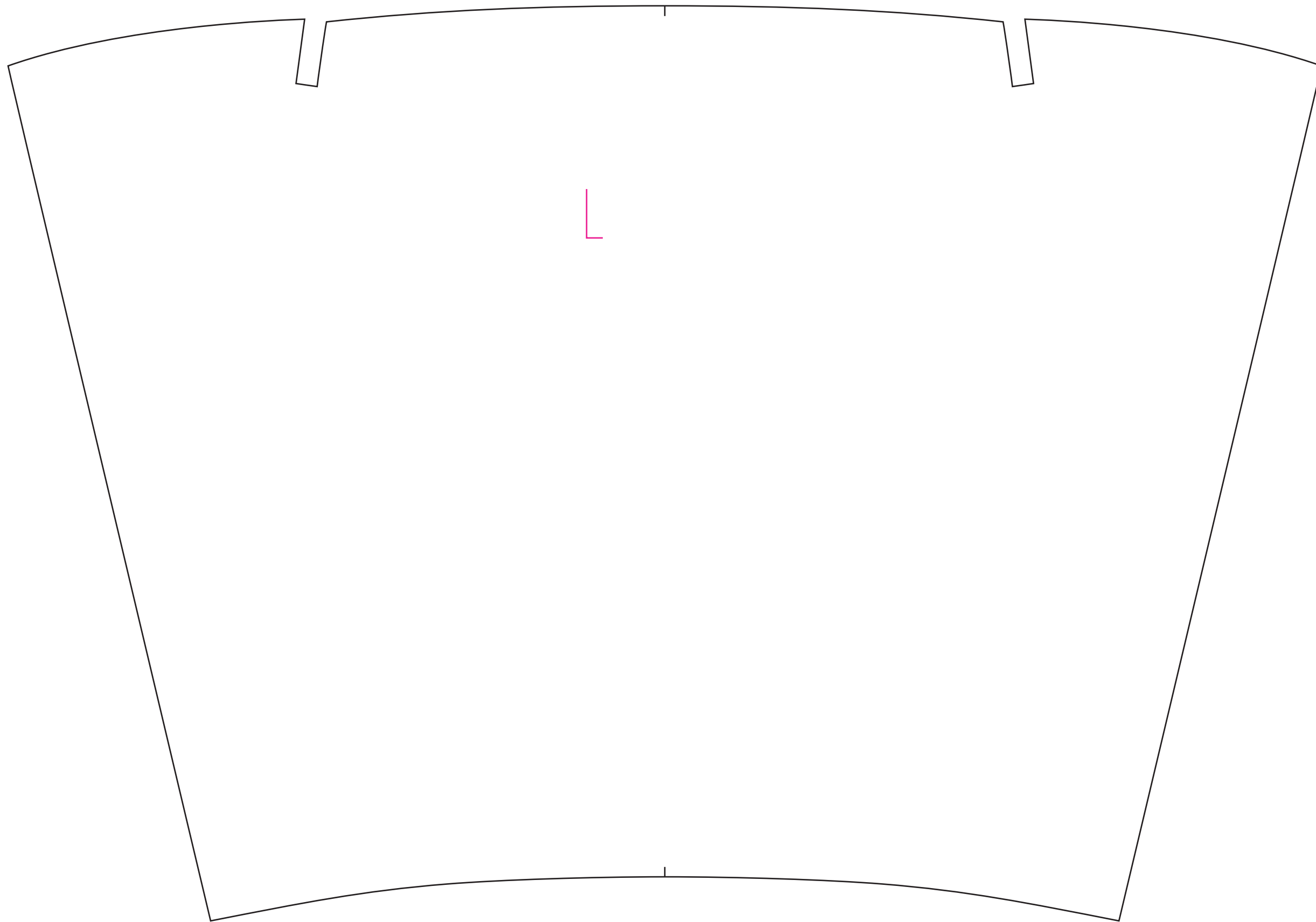

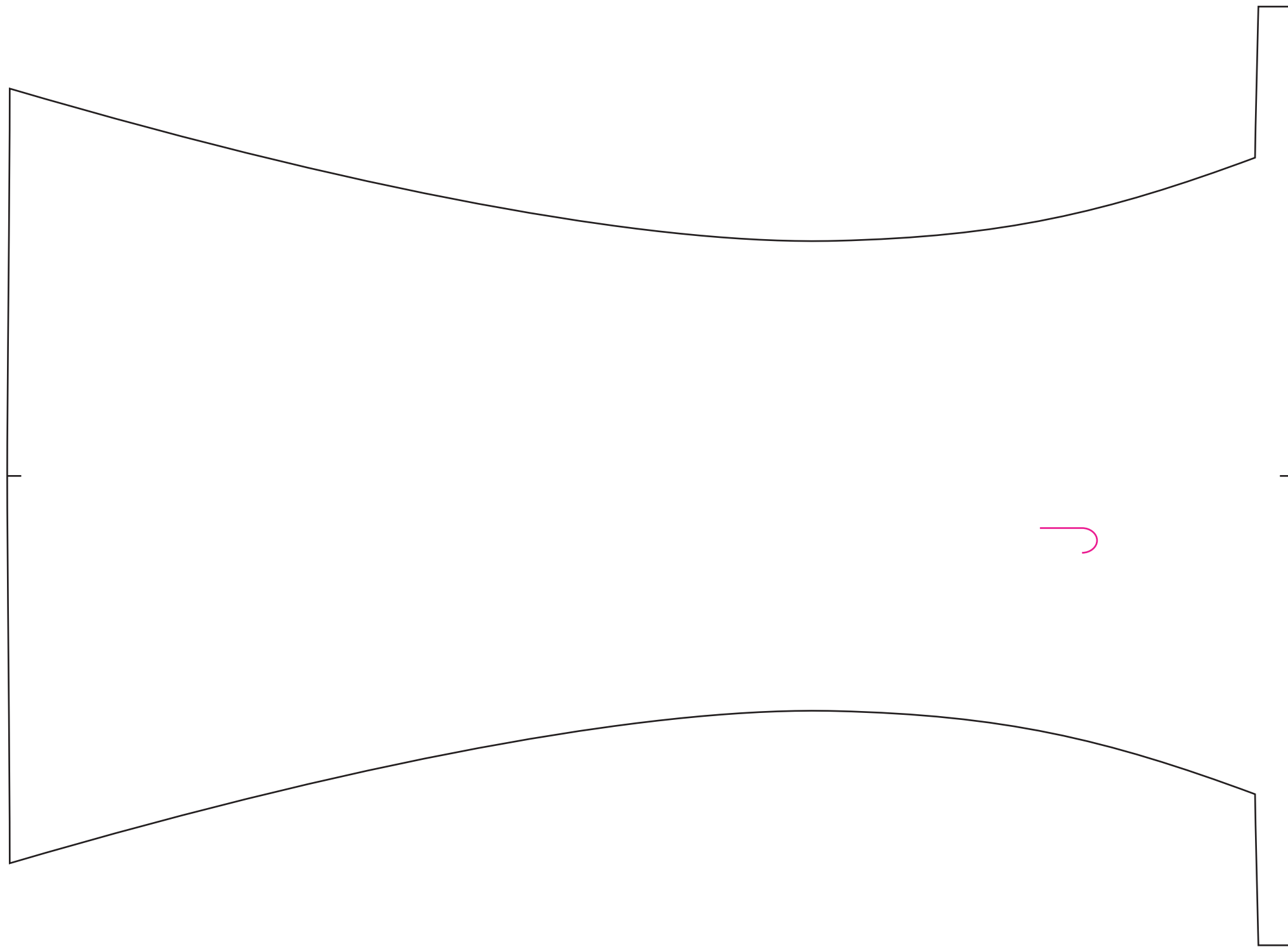

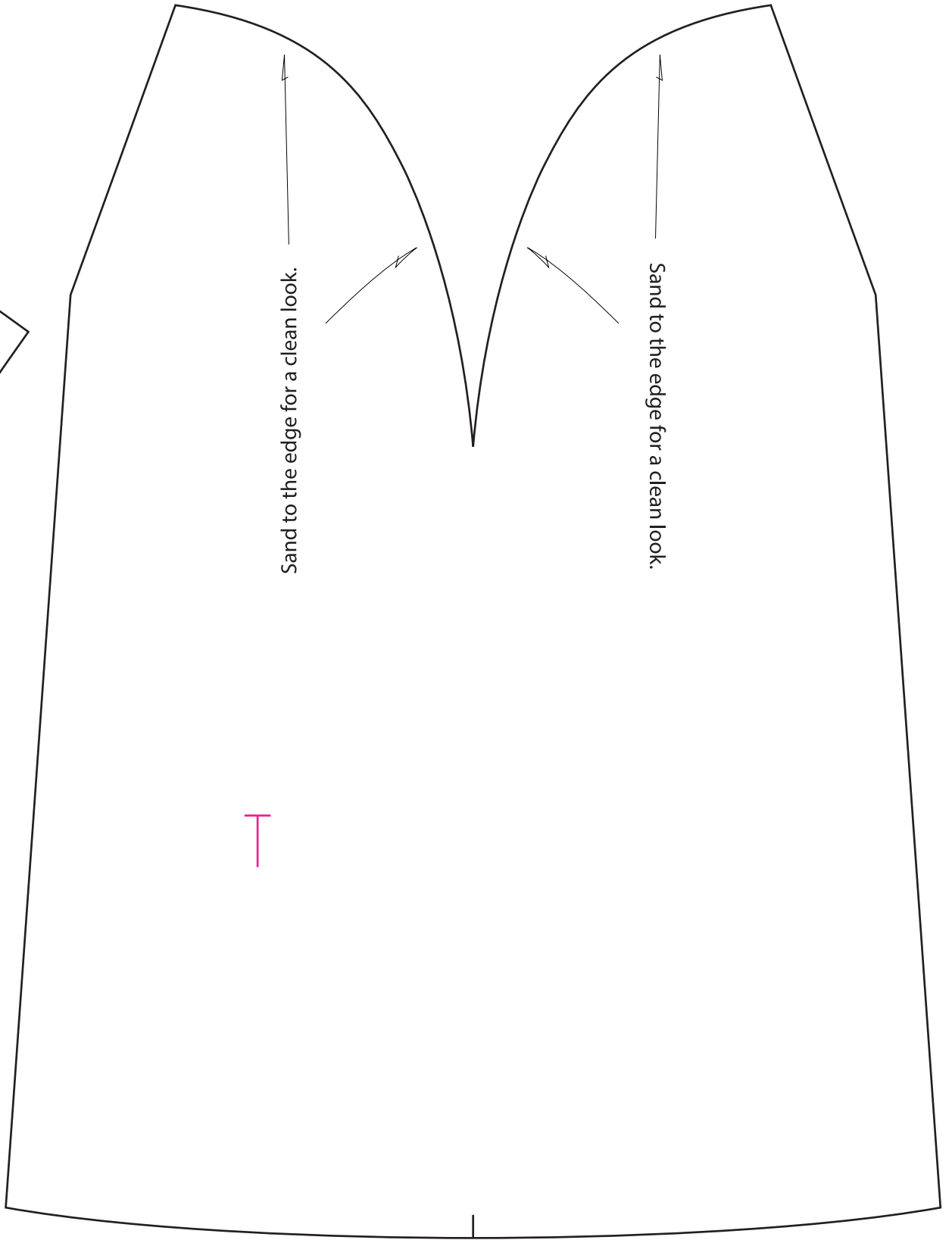
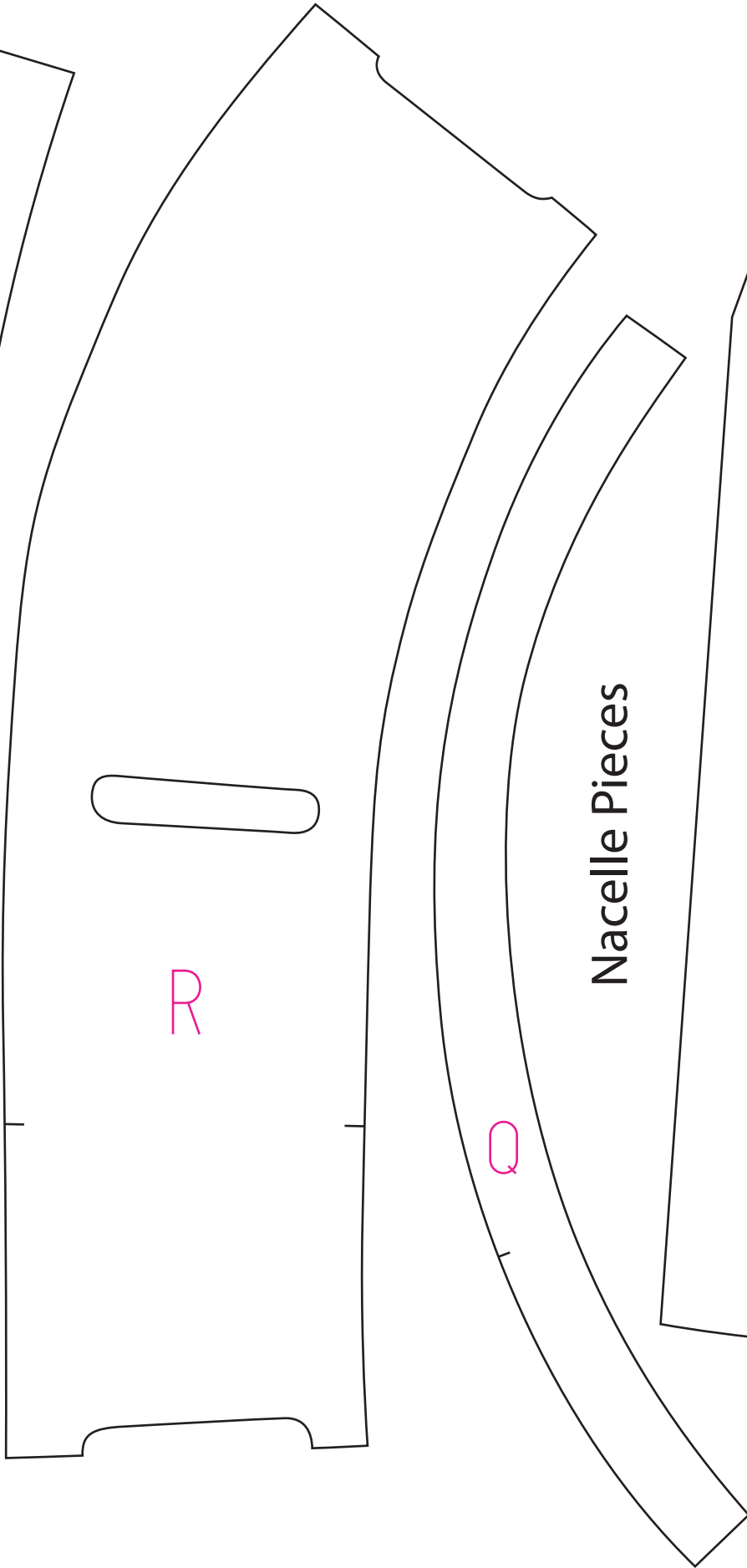
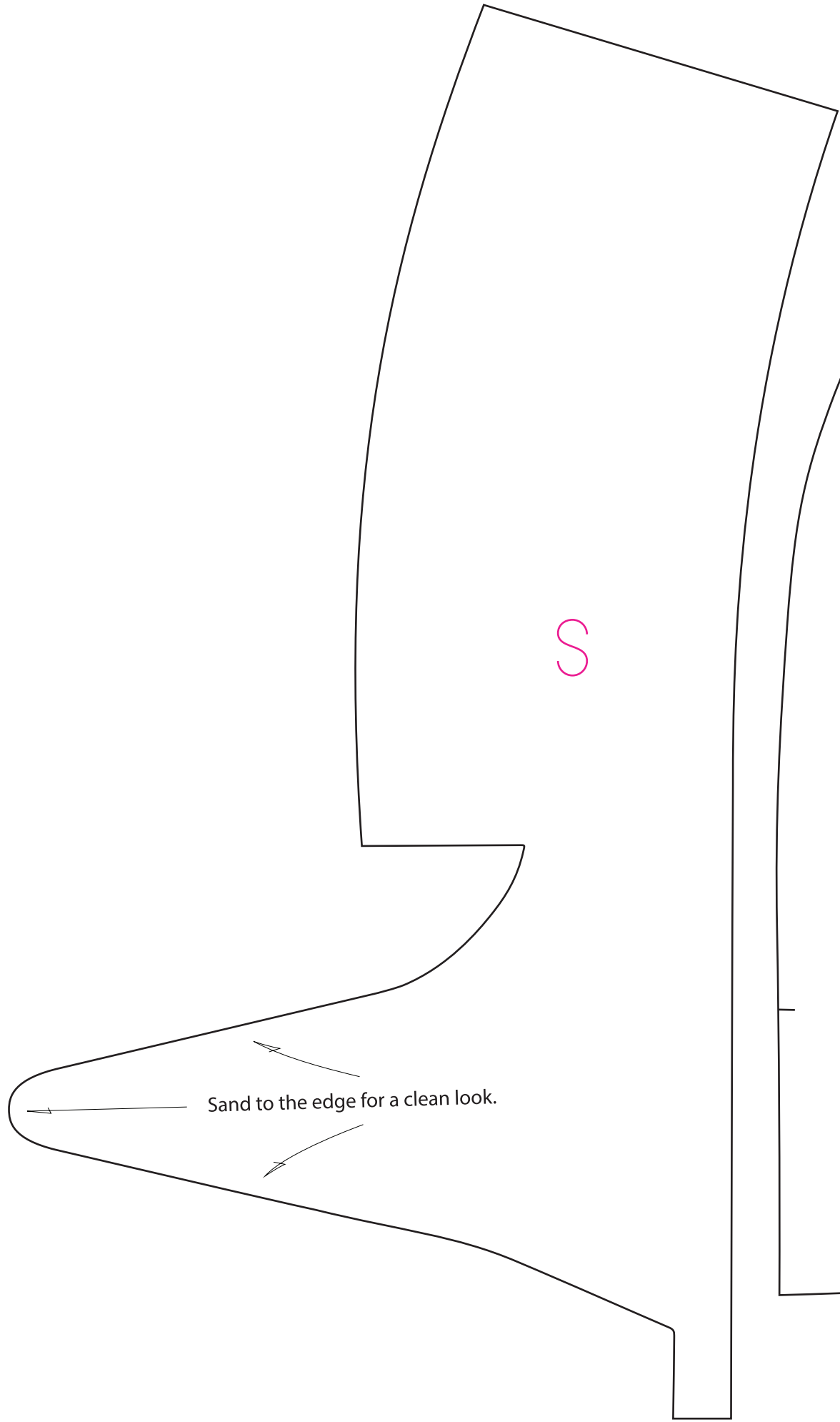

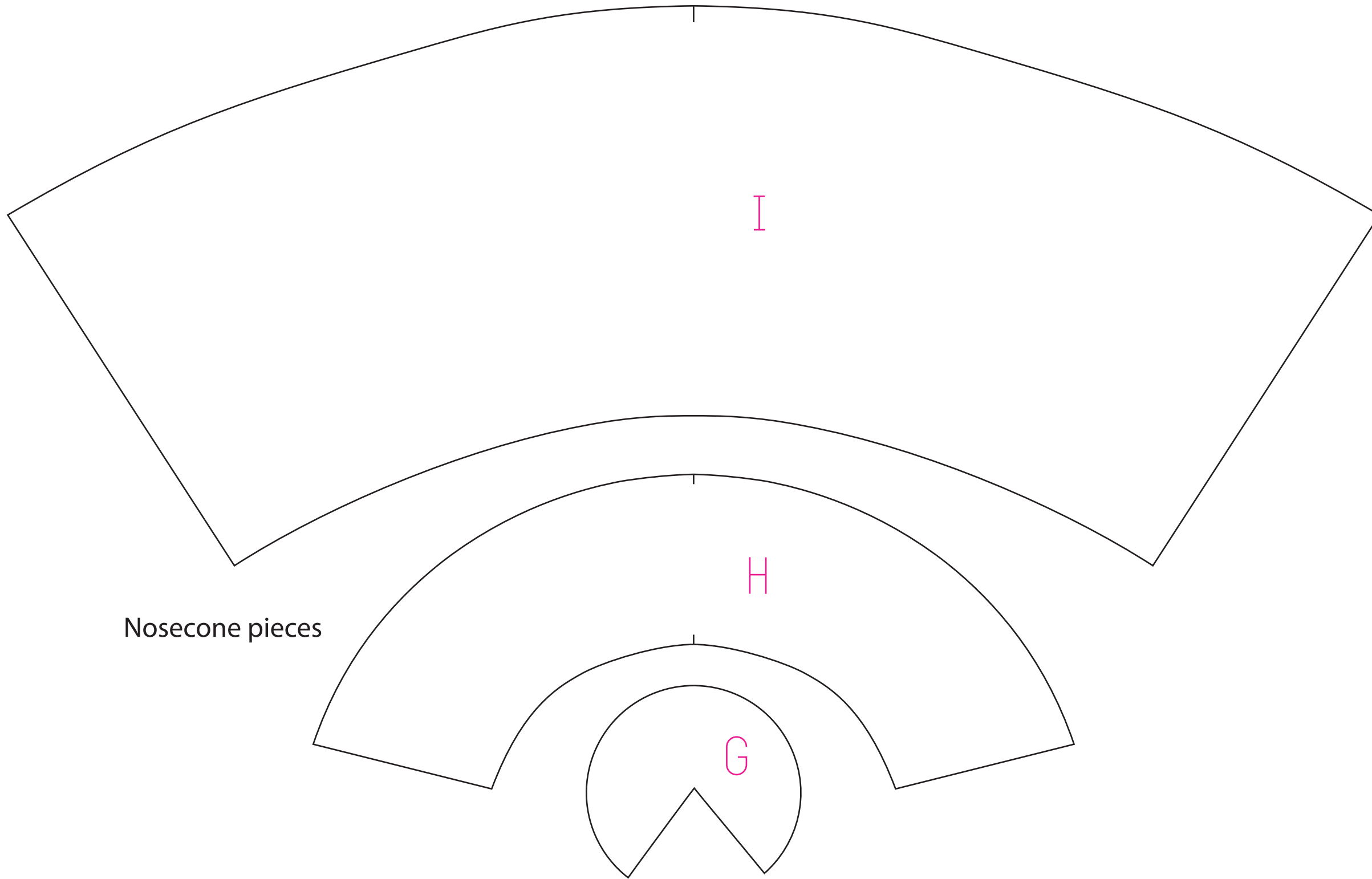

Nosecone pieces

I

H

G

