

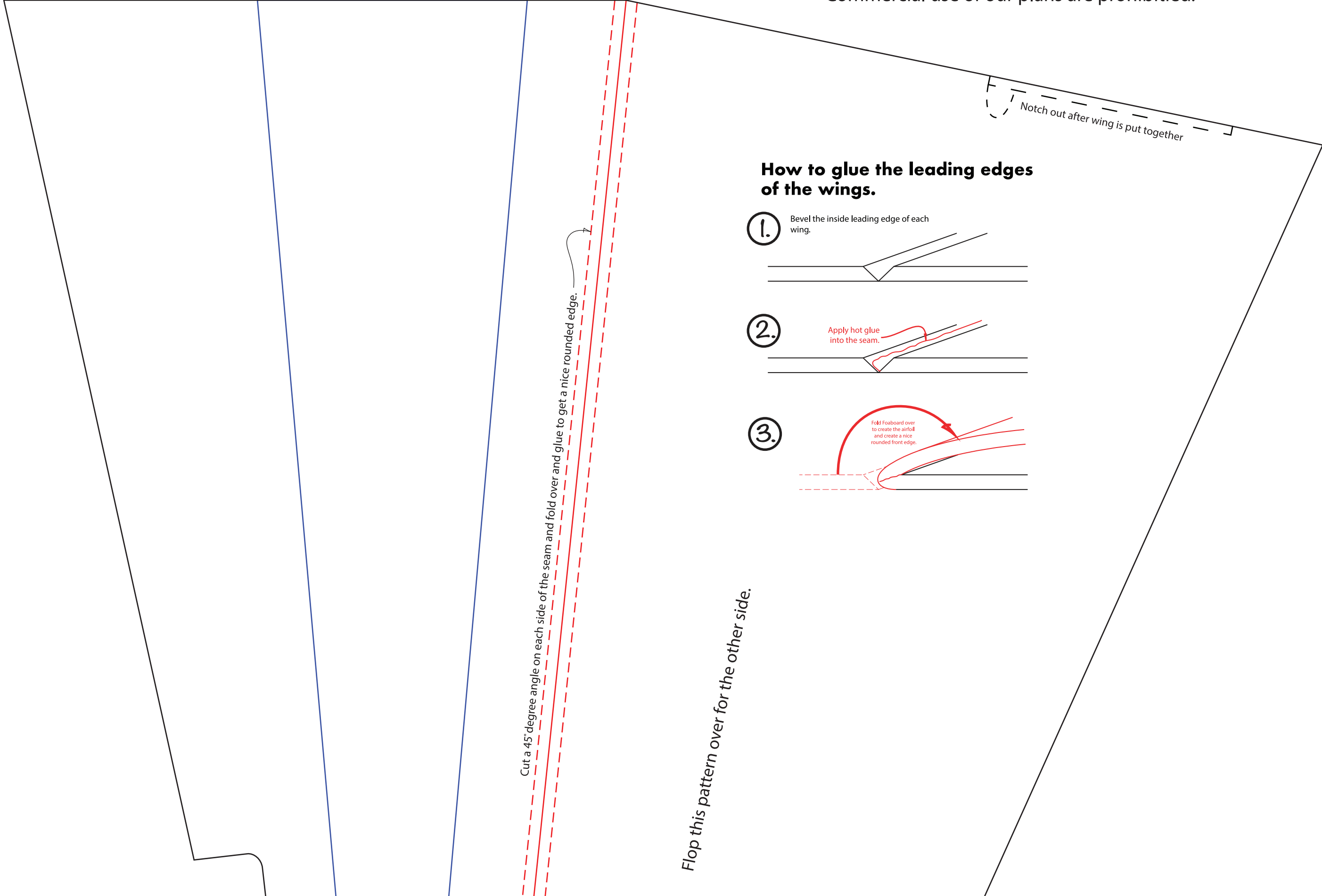

18"



Cut a 45° degree angle on each side of the seam and fold over and glue to get a nice rounded edge.

Flop this pattern over for the other side.

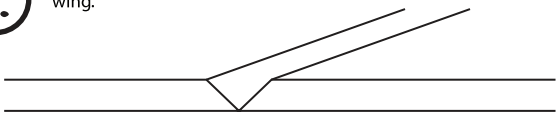
How to glue the leading edges of the wings.

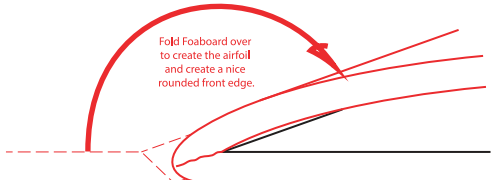
1. Bevel the inside leading edge of each wing.

2. Apply hot glue into the seam.

3. Fold foilboard over to create the airfoil and create a nice rounded front edge.

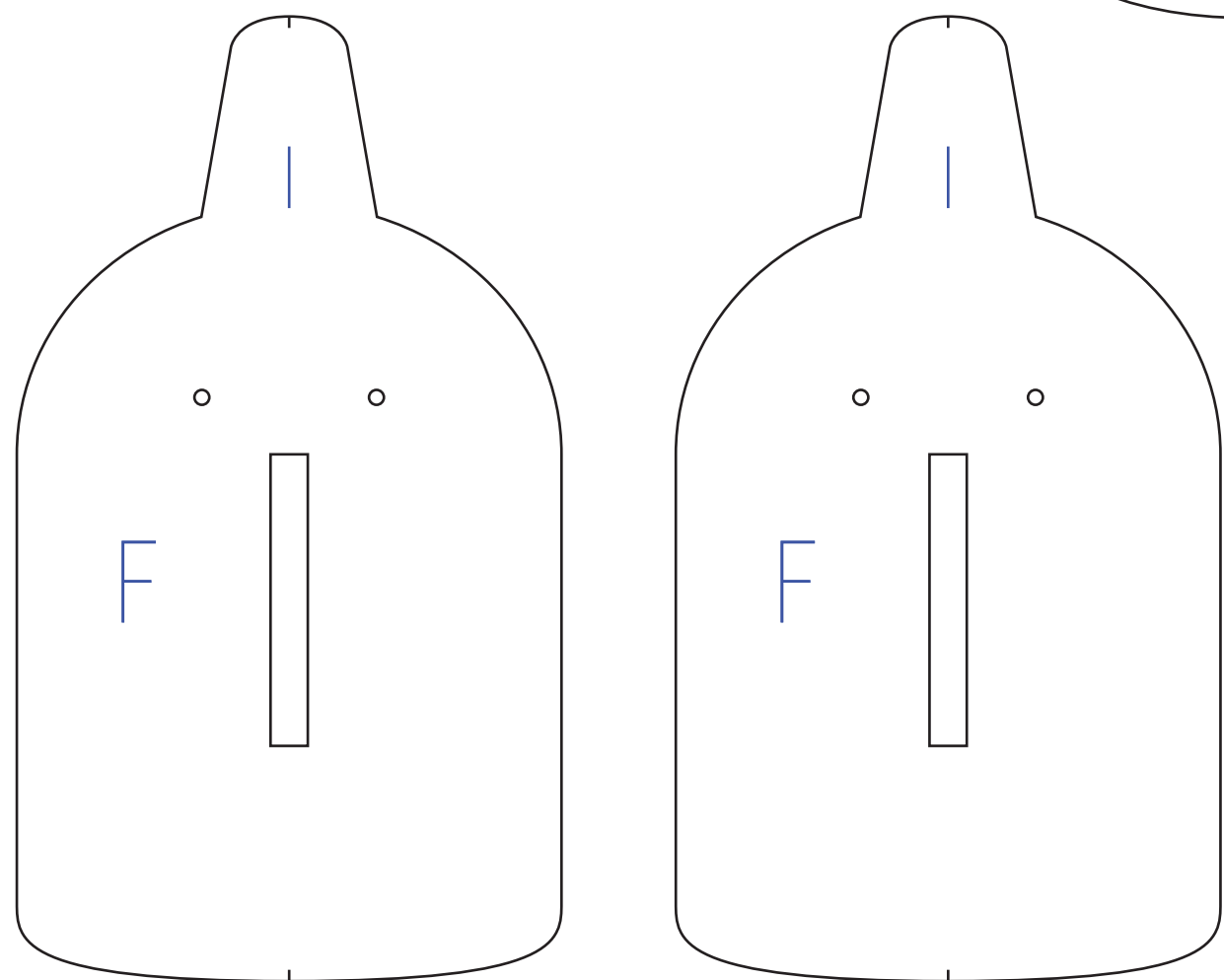
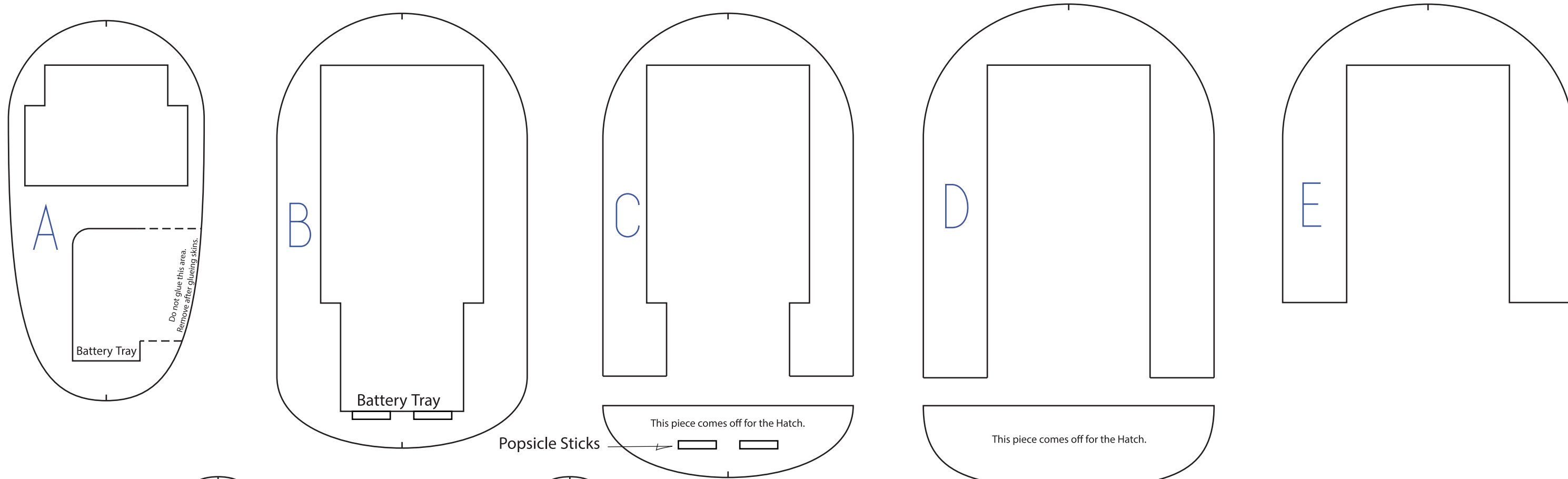
Notch out after wing is put together

18"

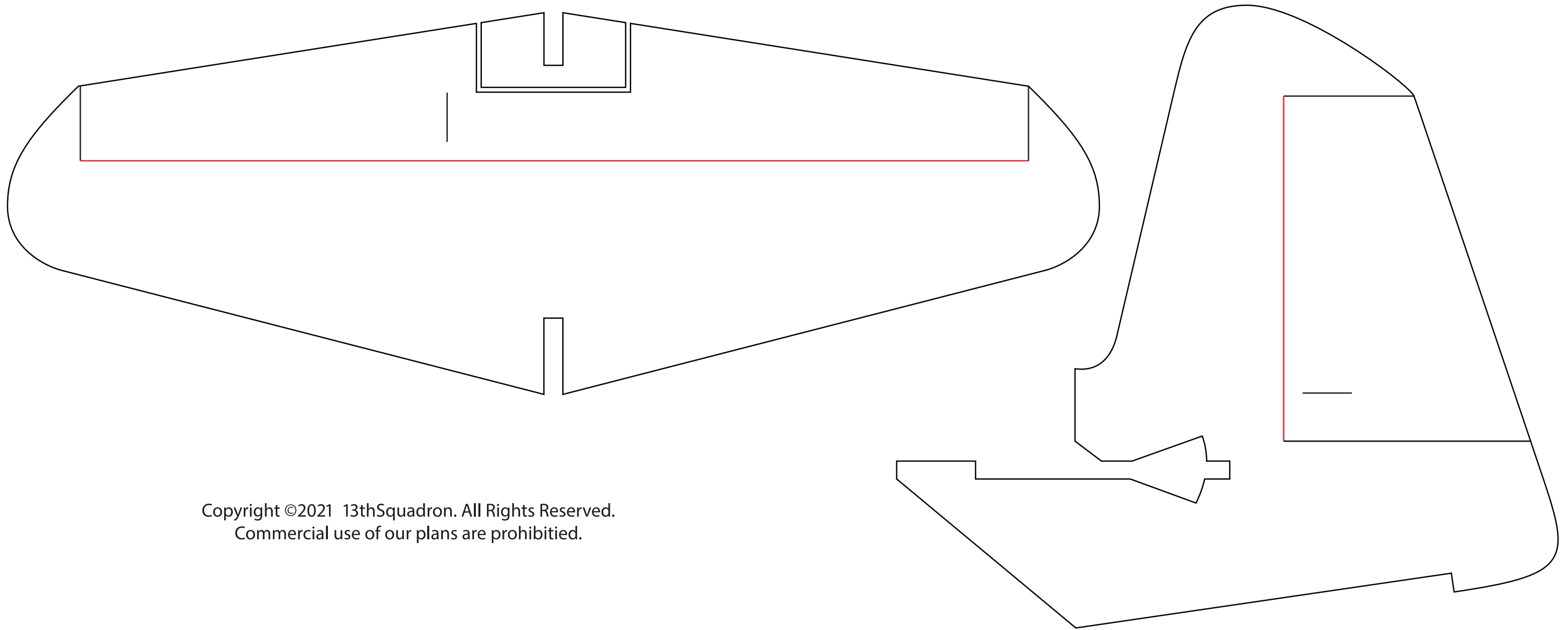

Copyright ©2021 13thSquadron. All Rights Reserved.
Commercial use of our plans are prohibited.



Copyright ©2021 13thSquadron. All Rights Reserved.
Commercial use of our plans are prohibited.

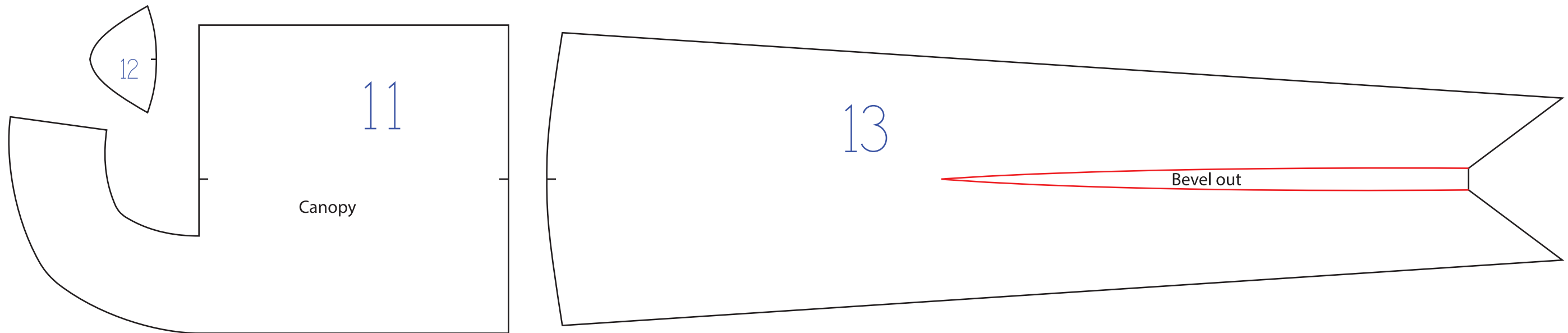

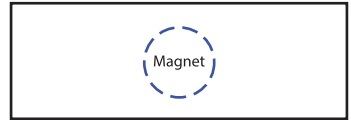
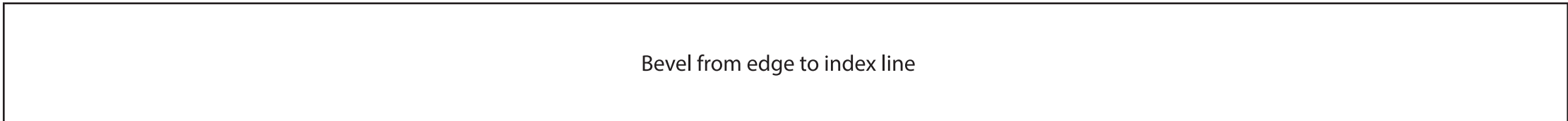
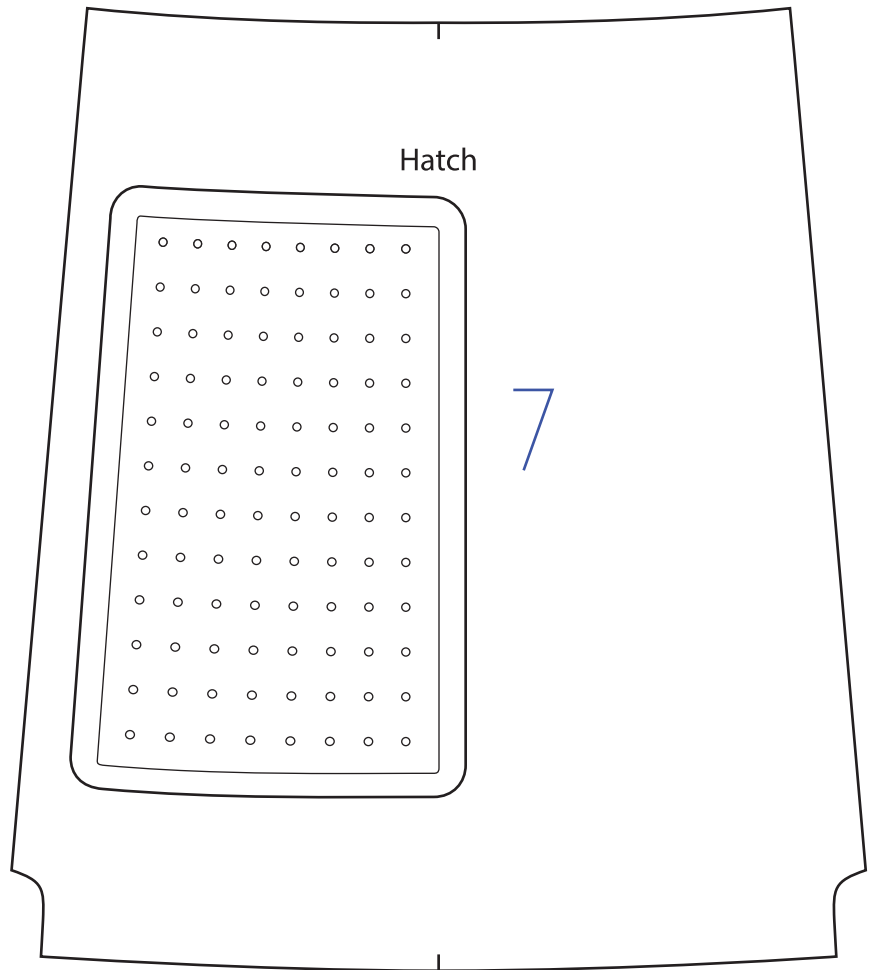
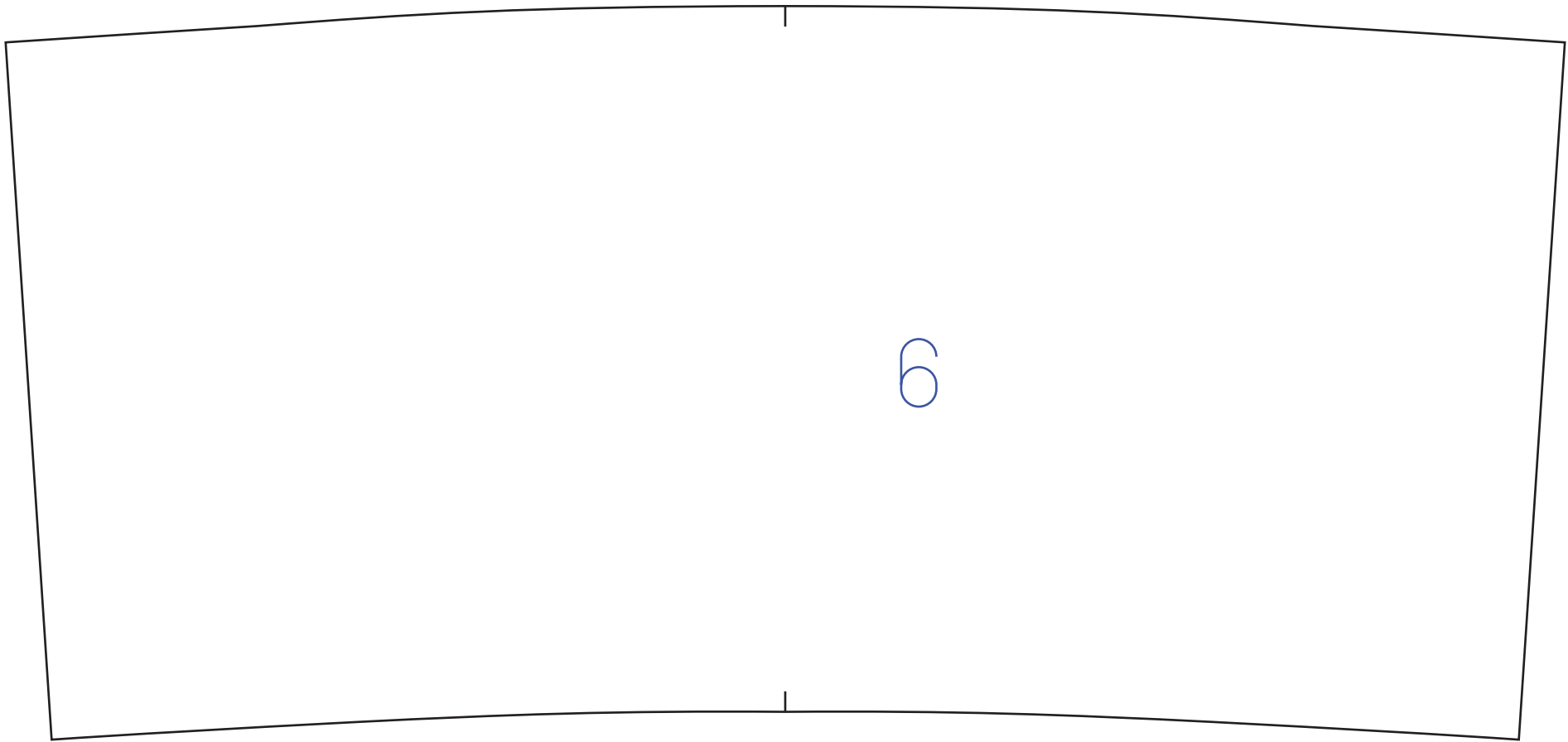

Popsicle stick reinforcer
(Look at build photos for reference)

Copyright ©2021 13thSquadron. All Rights Reserved.
Commercial use of our plans are prohibited.

10

Mold and glue this piece, then slide the "F" Formers into the front section of the piece.
From there slide the Vertical and Horizontal Stabilizer in place.
Make sure your Horizontal and Vertical Stabilizer are parallel/level with the wings.

18"

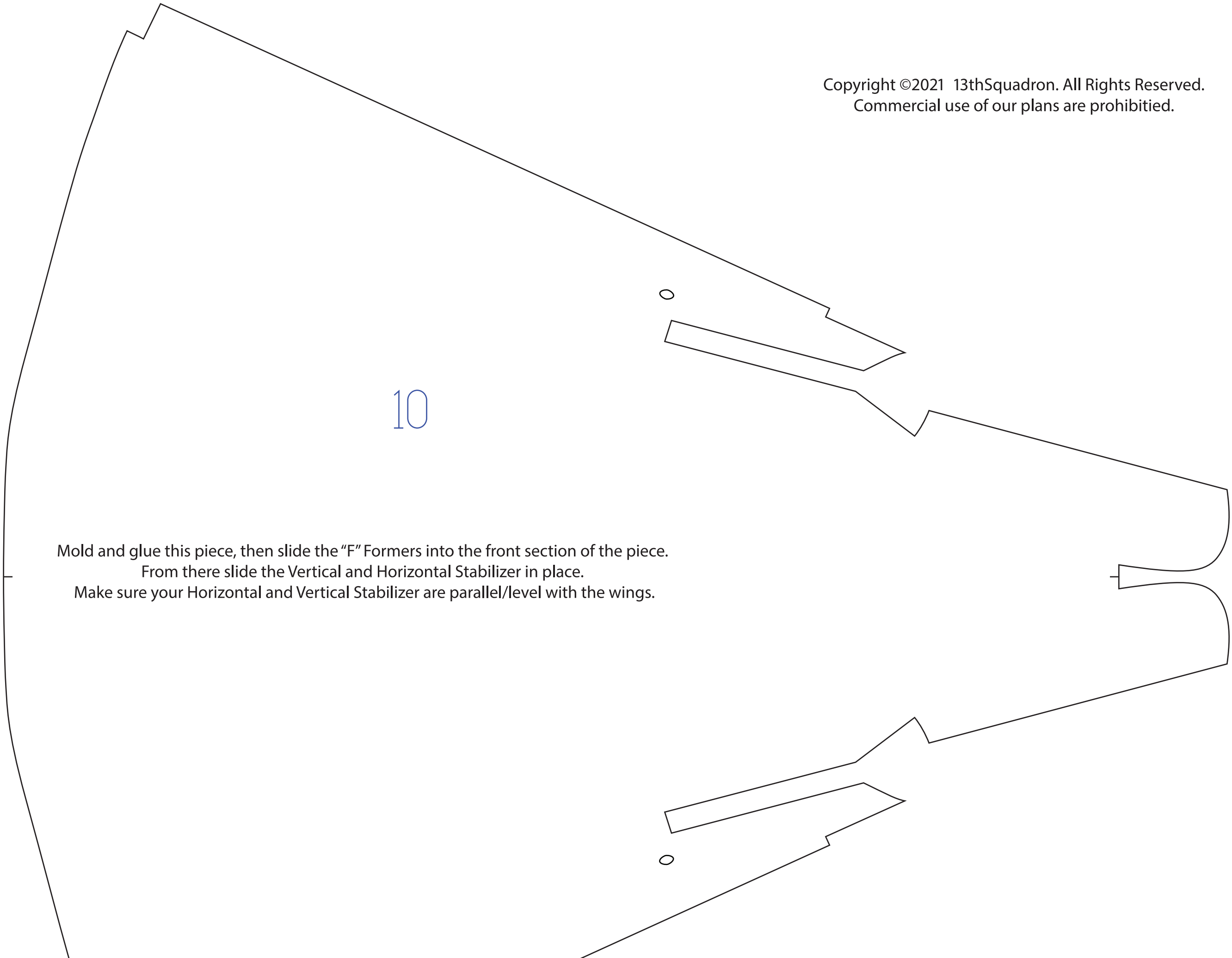

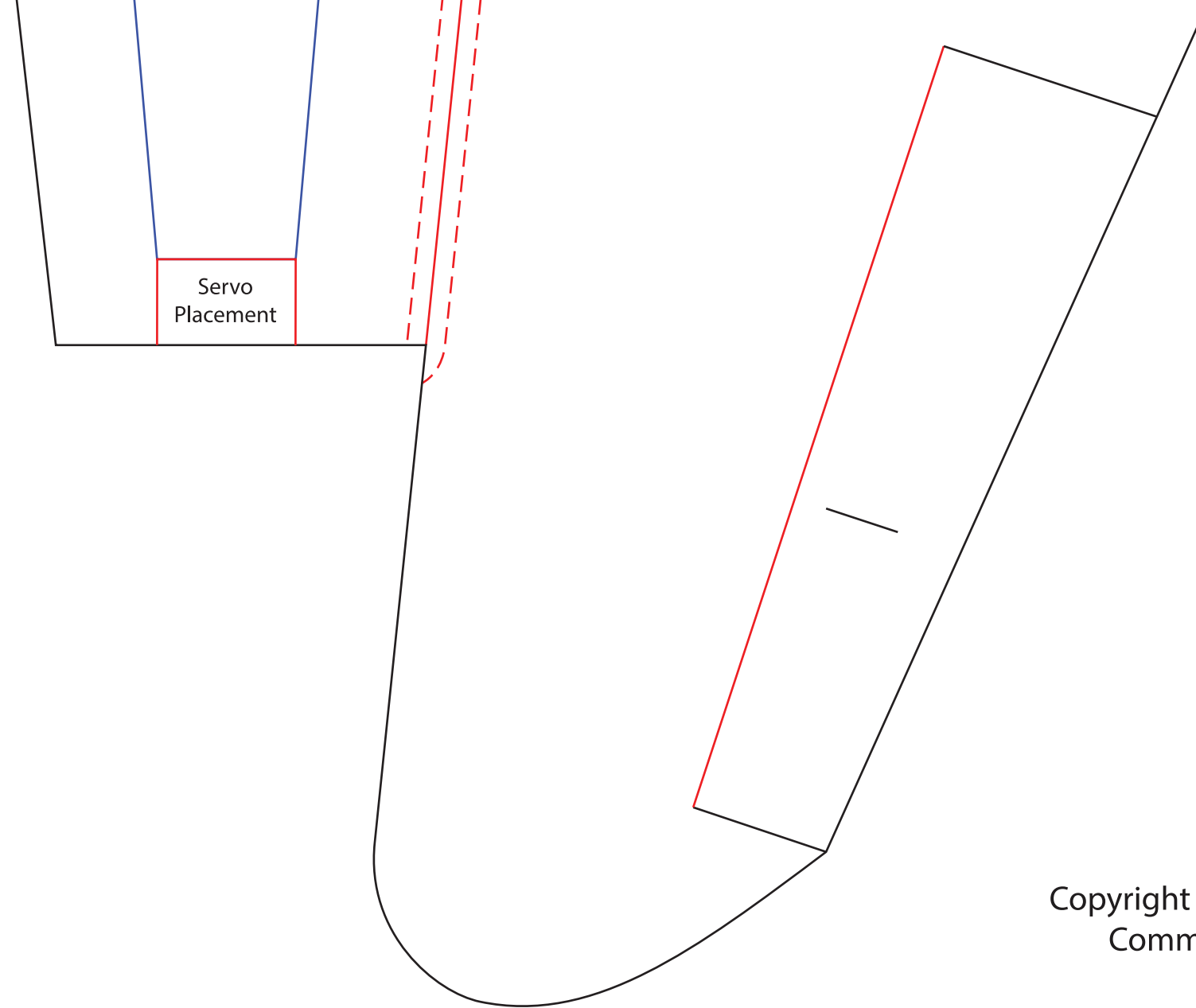

Servo
Placement

Copyright ©2021 13thSquadron. All Rights Reserved.
Commercial use of our plans are prohibited.

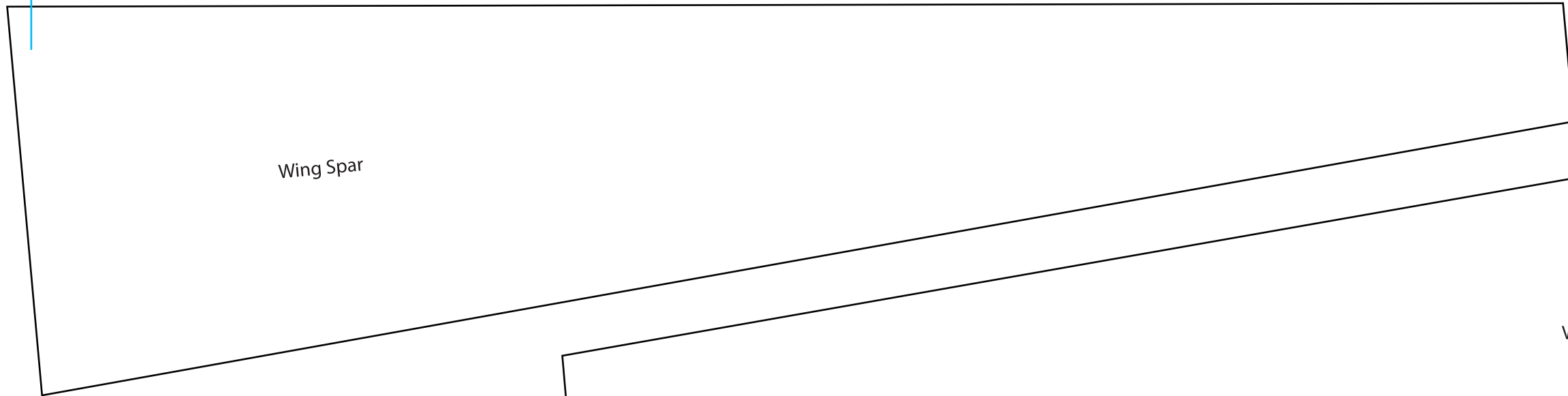

Wing Spar

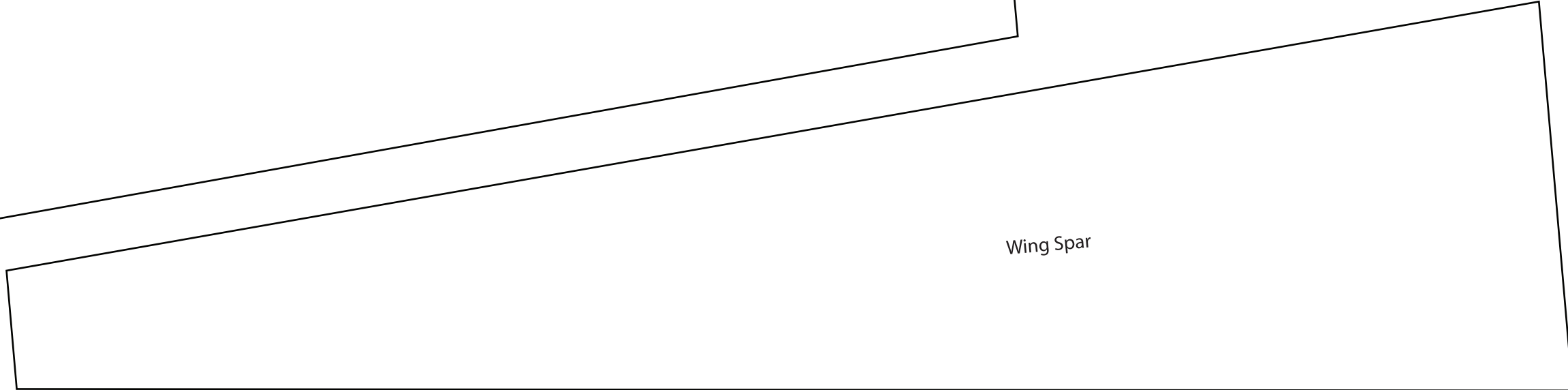

Wing Spar

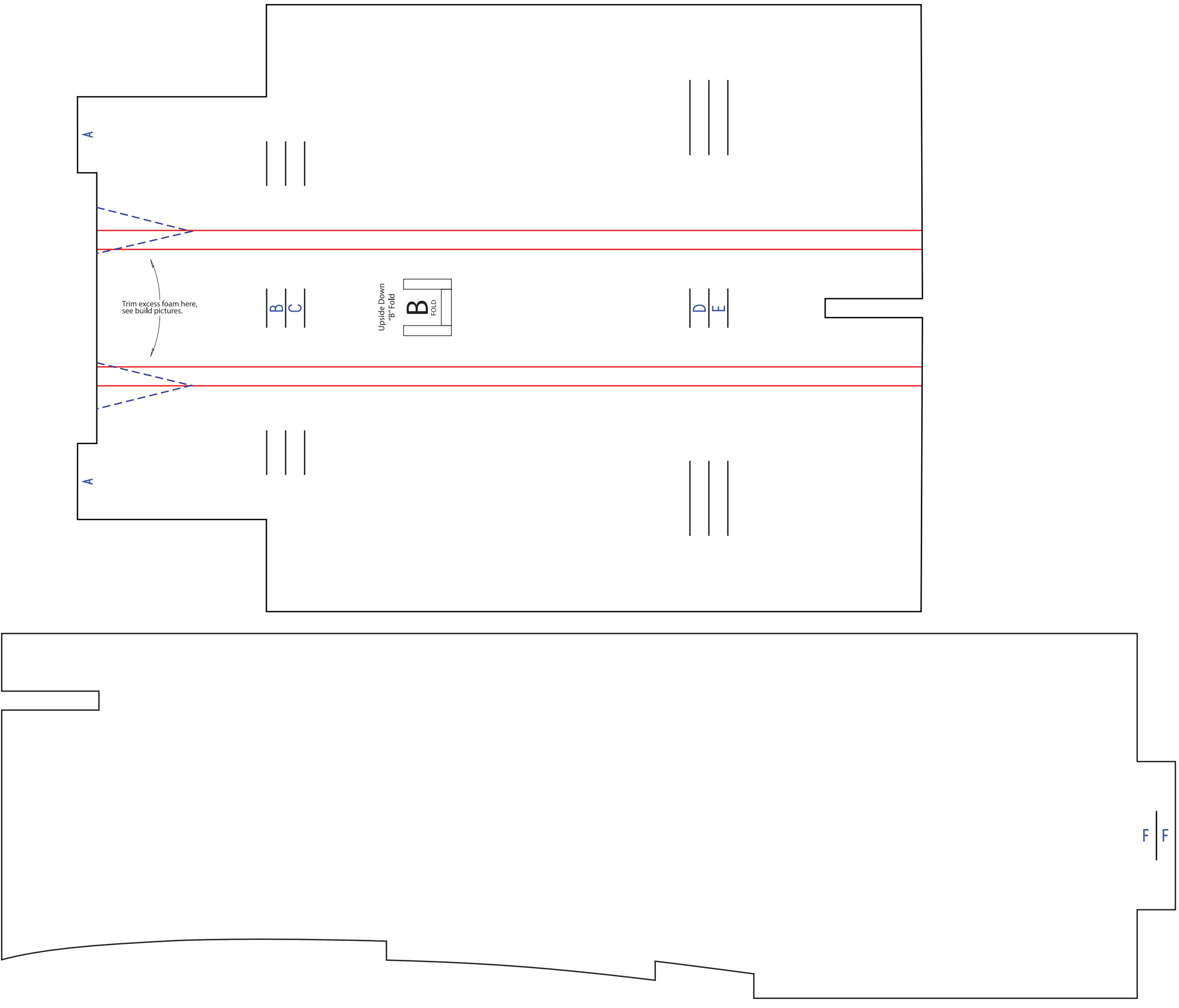

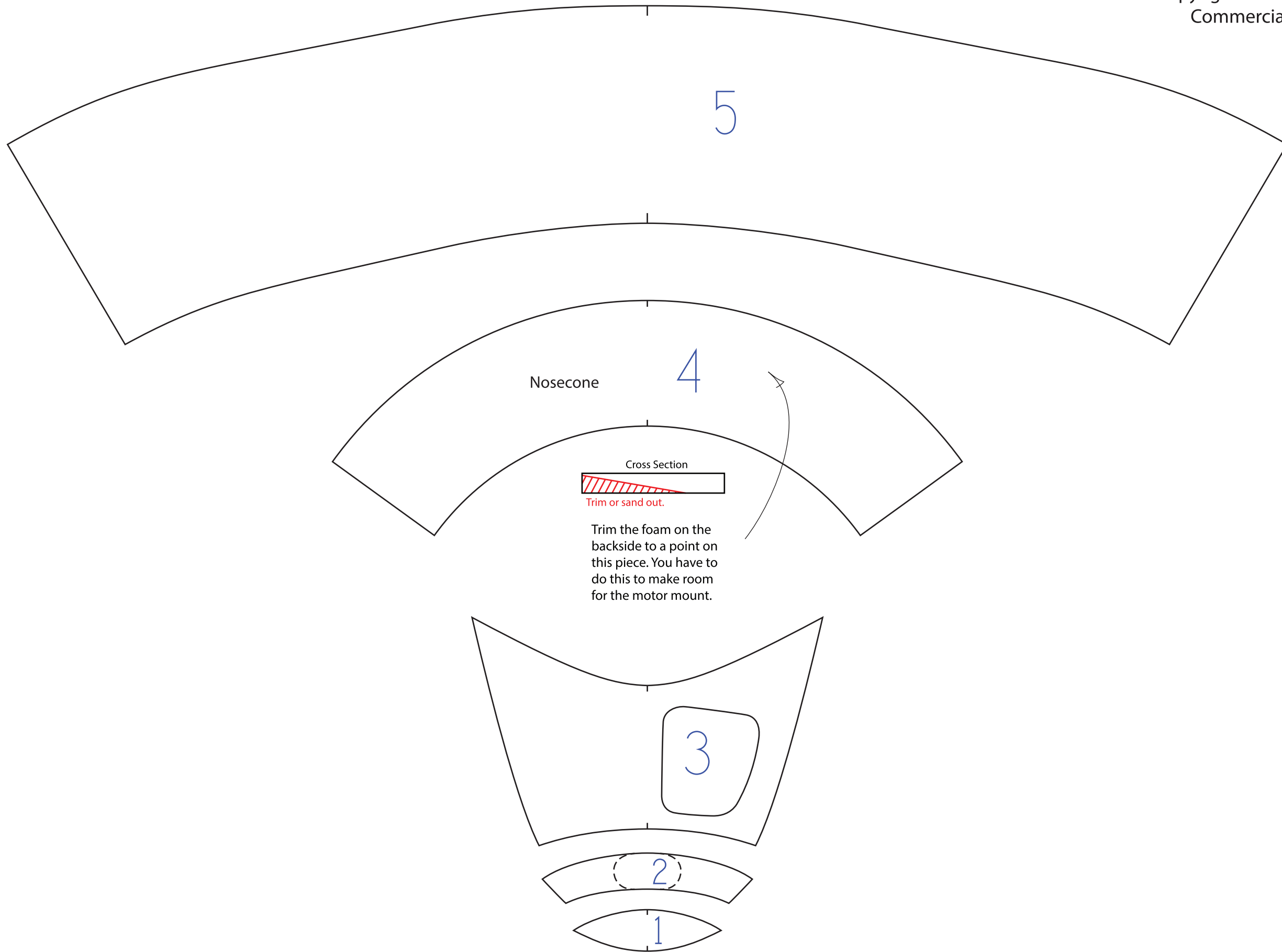

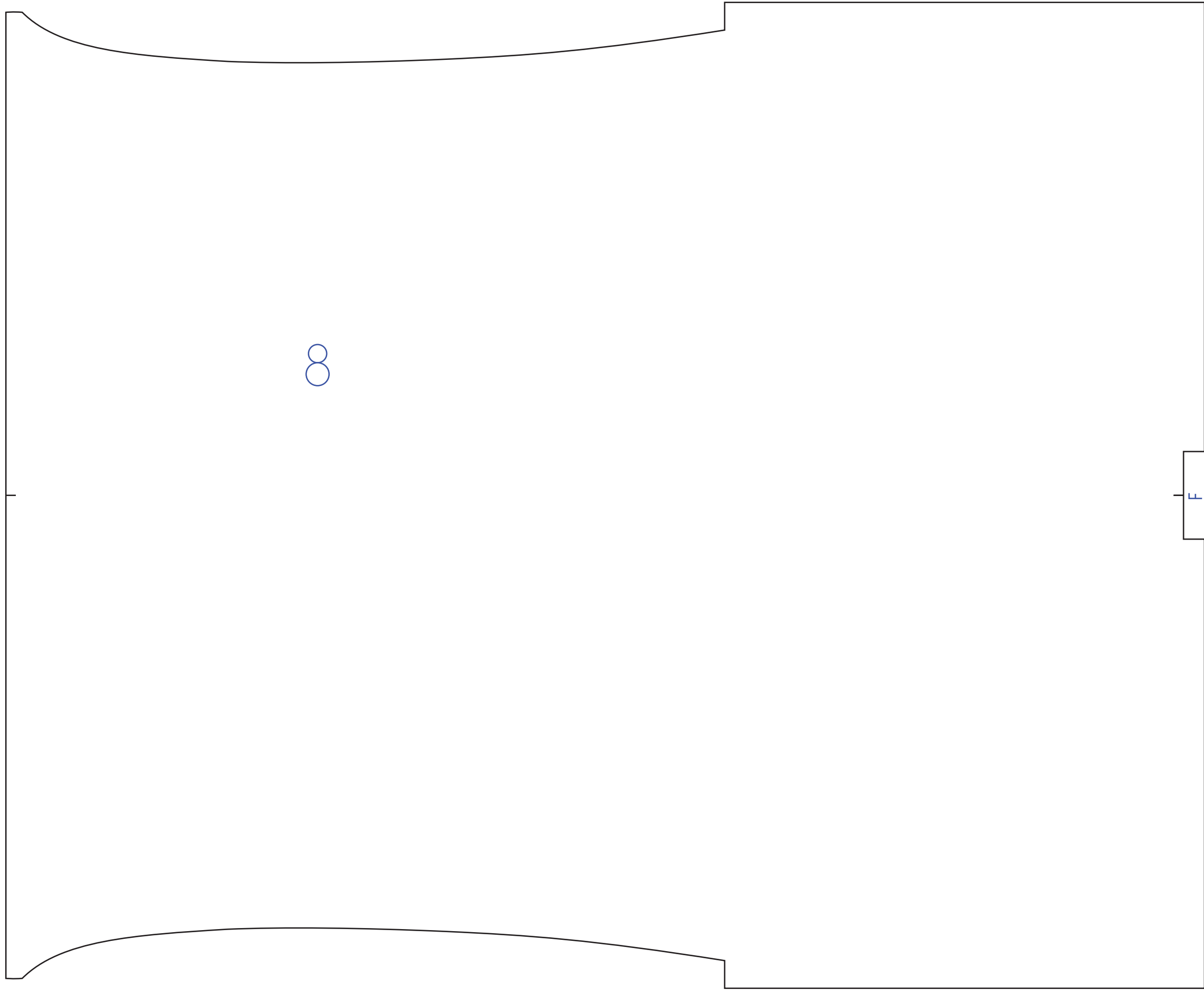

F

Copyright ©2021 13thSquadron. All Rights Reserved.
Commercial use of our plans are prohibited.

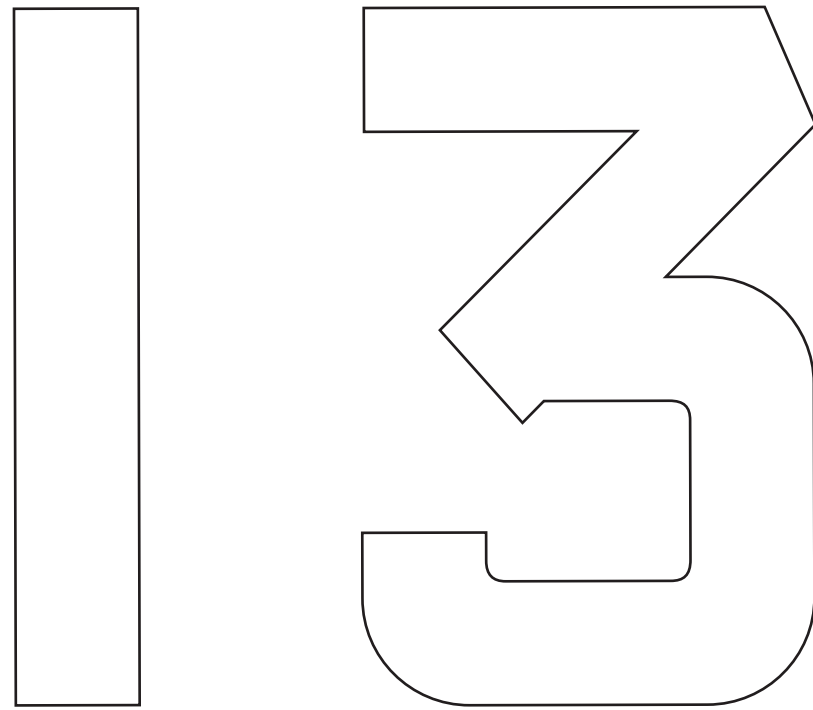
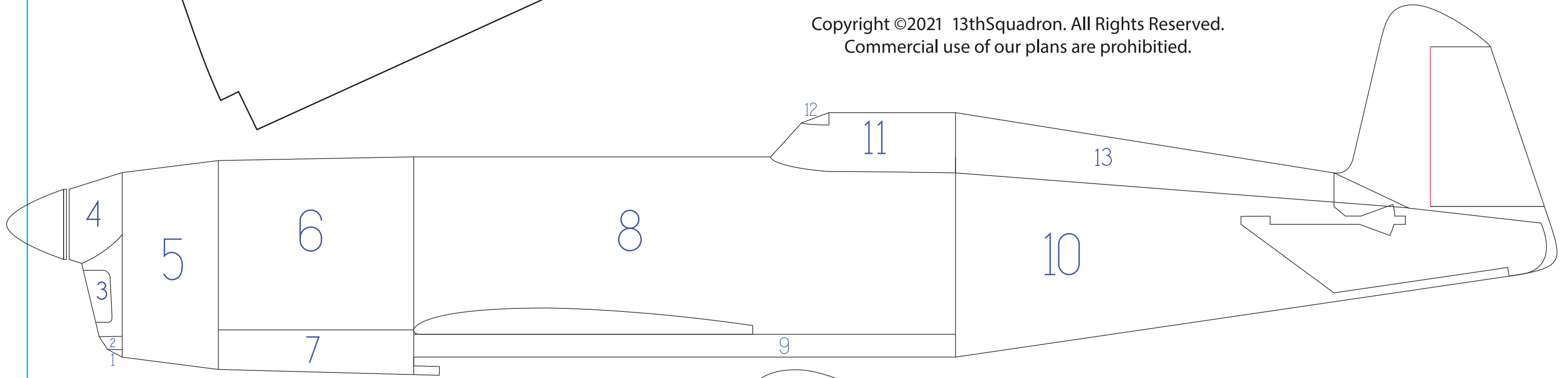

Wing Numbers

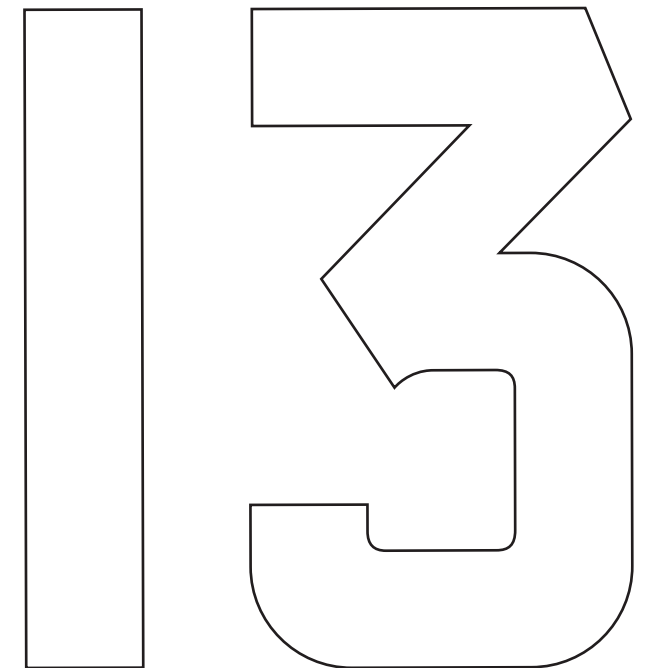

Fuselage Numbers