

Wing Spar

Wing Spar

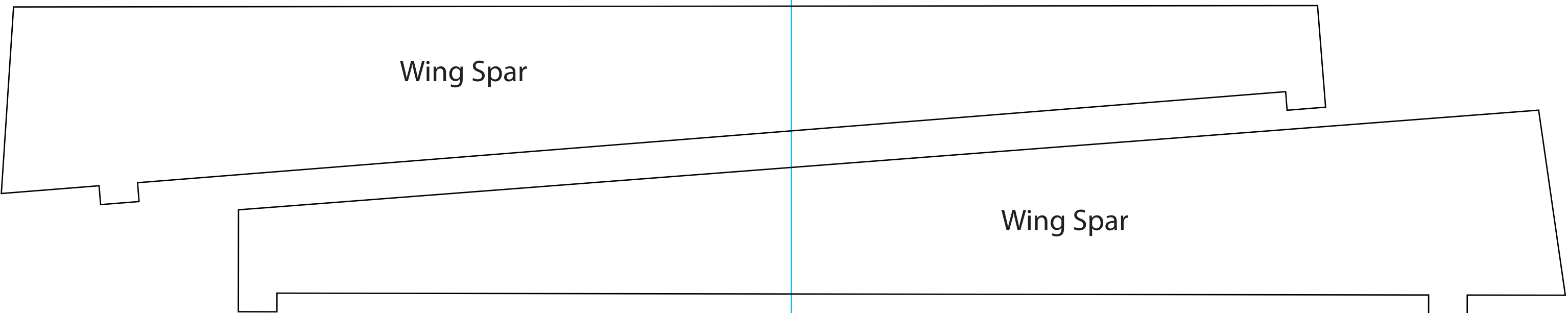

Wing Spar

Wing Spar

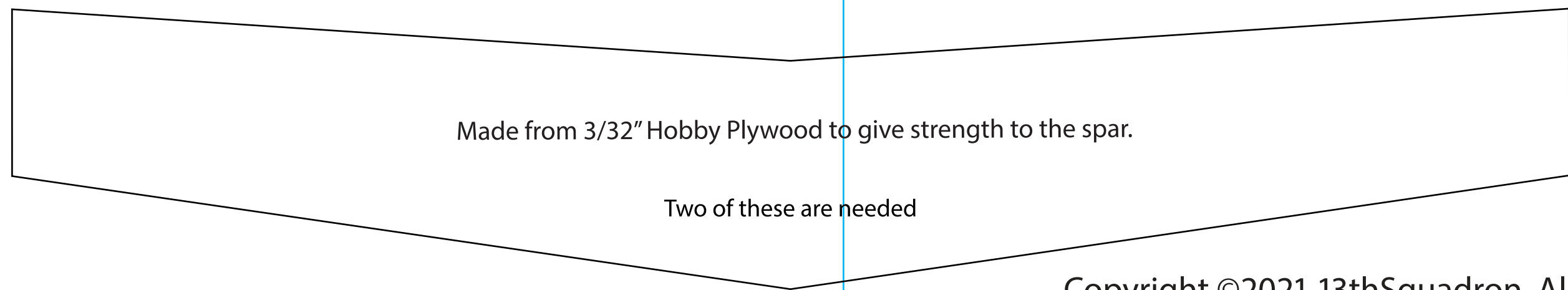

Made from 3/32" Hobby Plywood to give strength to the spar.

Two of these are needed

Copyright ©2021 13thSquadron. All Rights Reserved.  
Commercial use of our plans are prohibited.

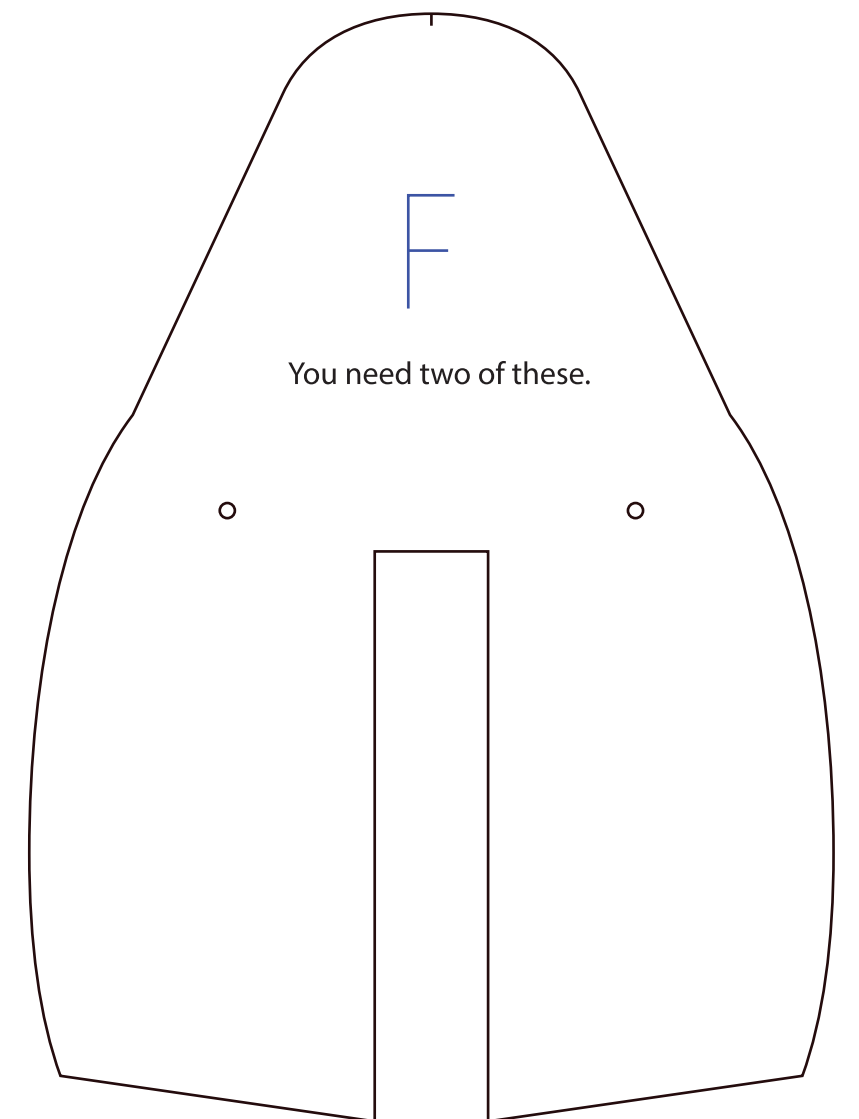
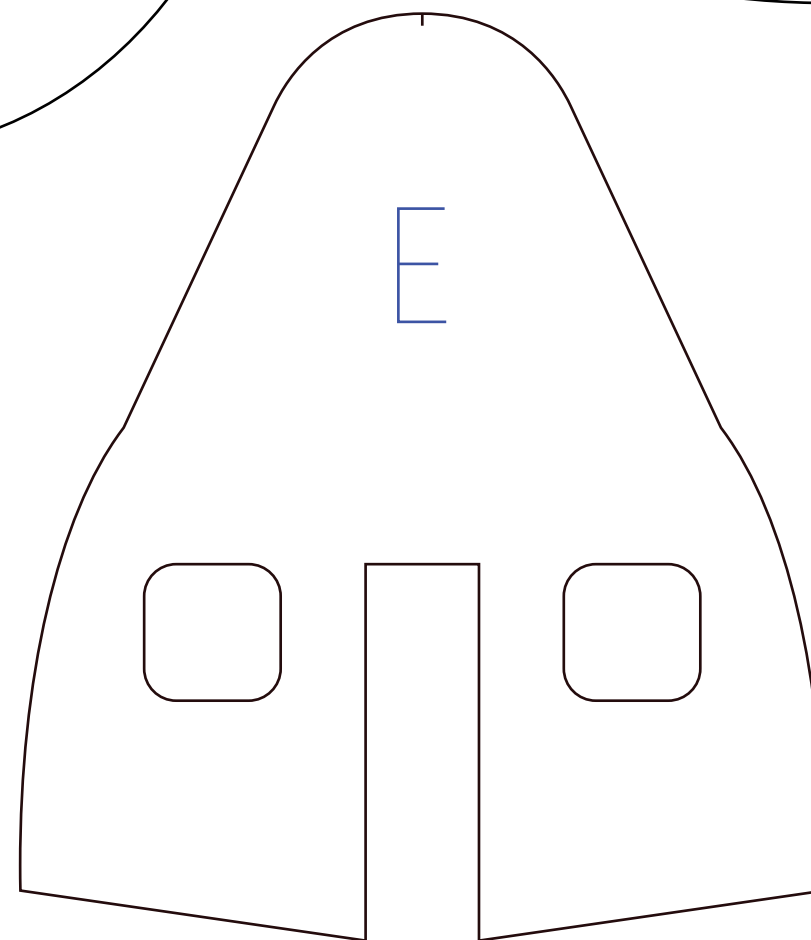
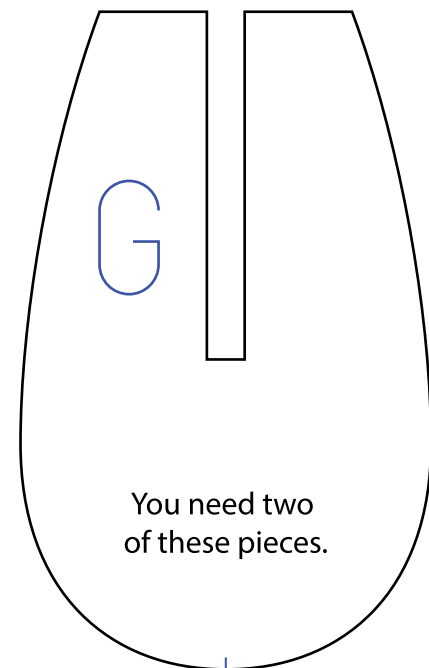
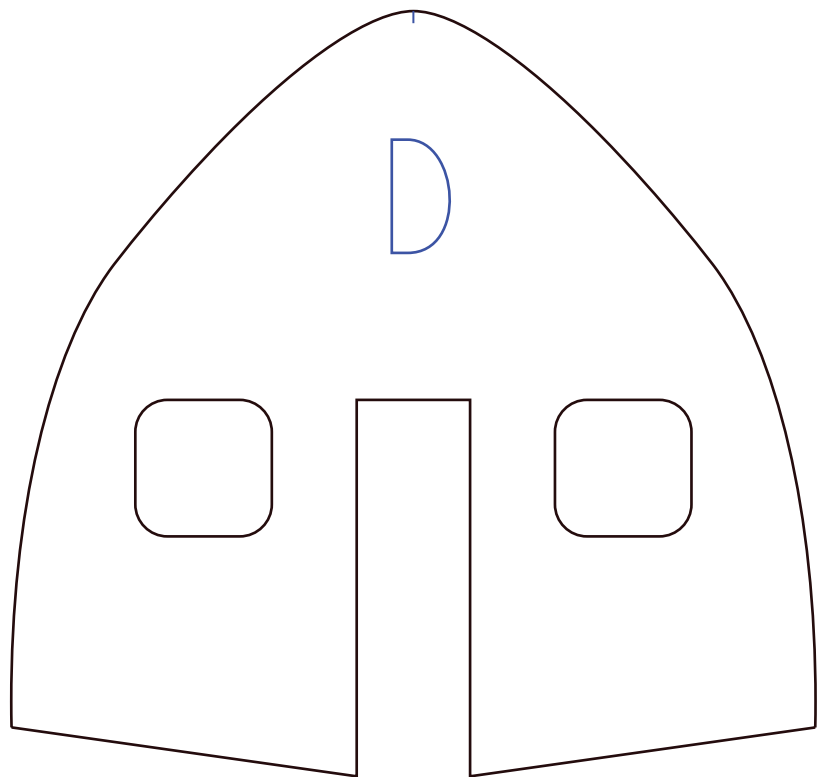
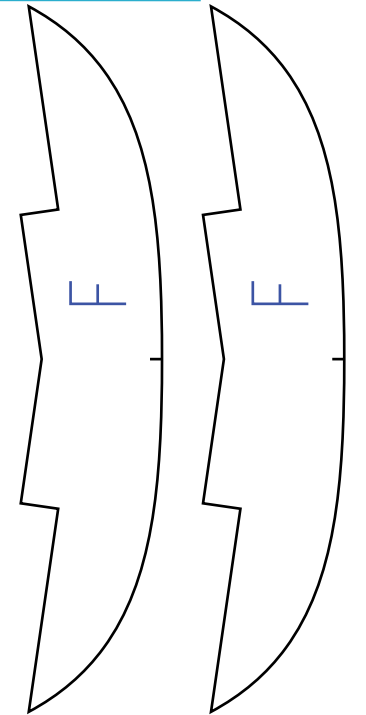
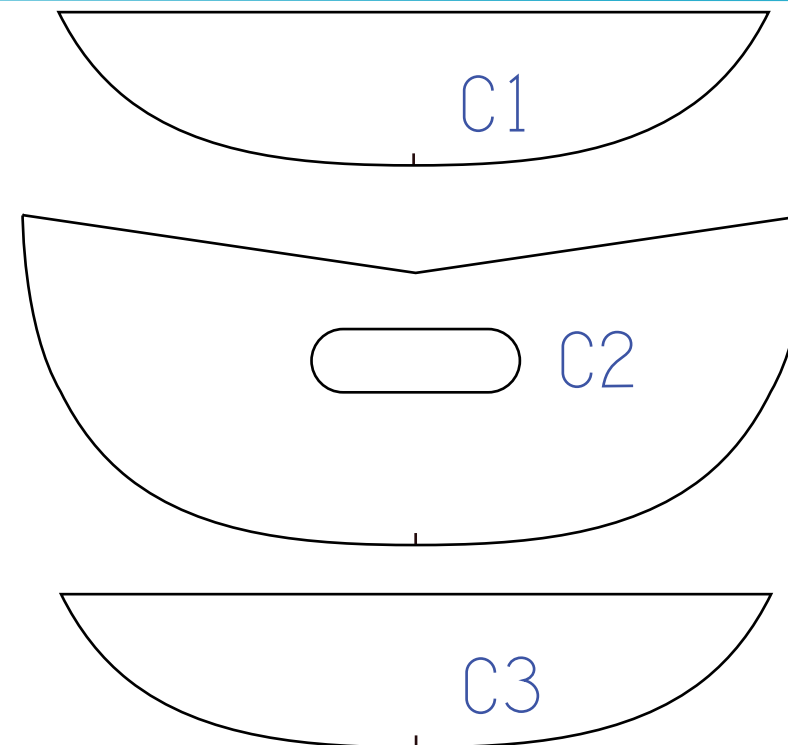
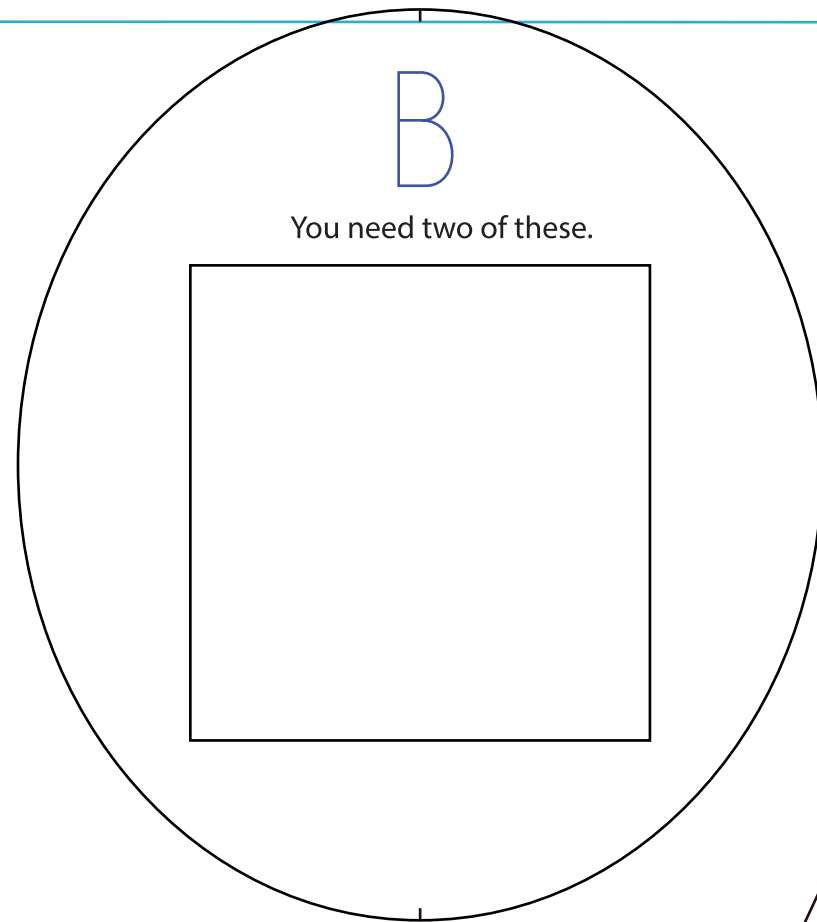
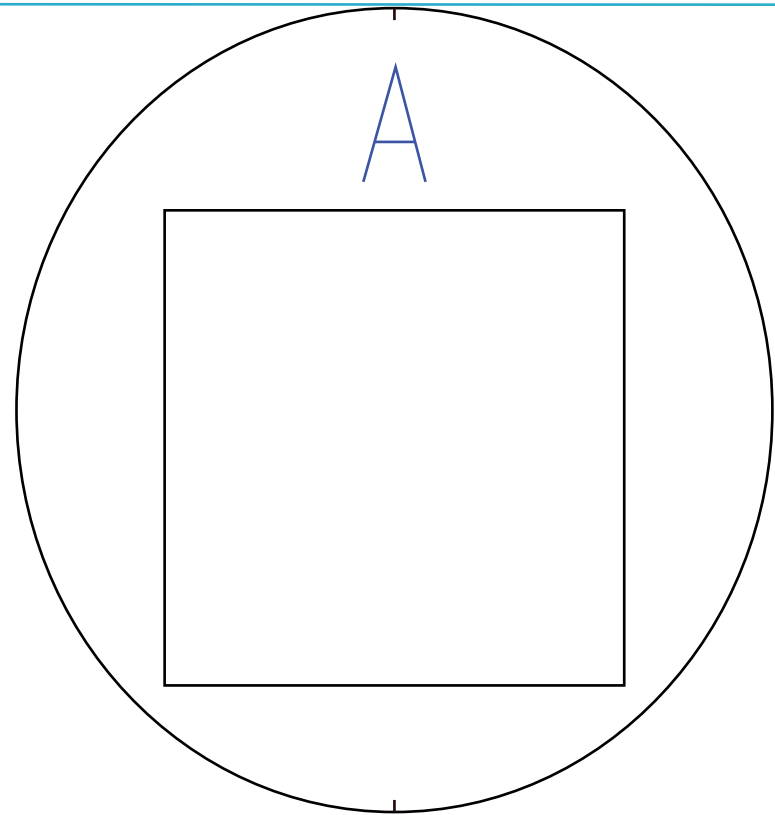

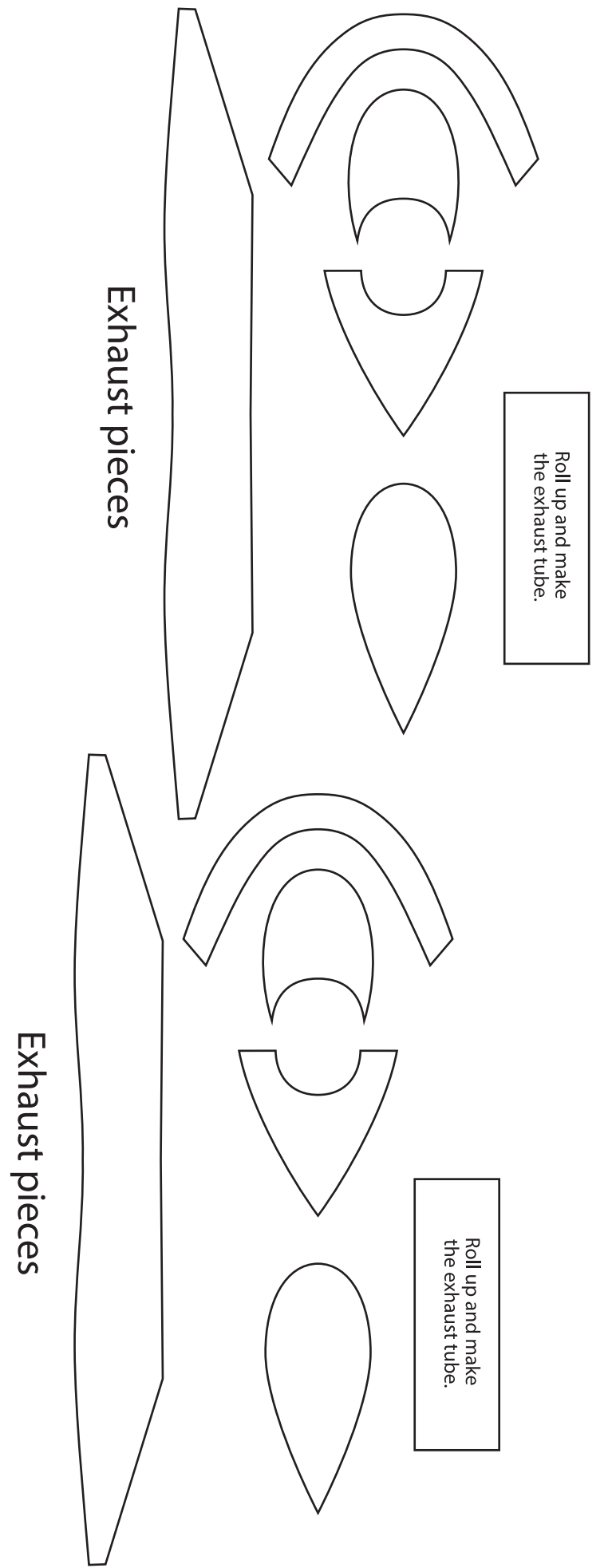
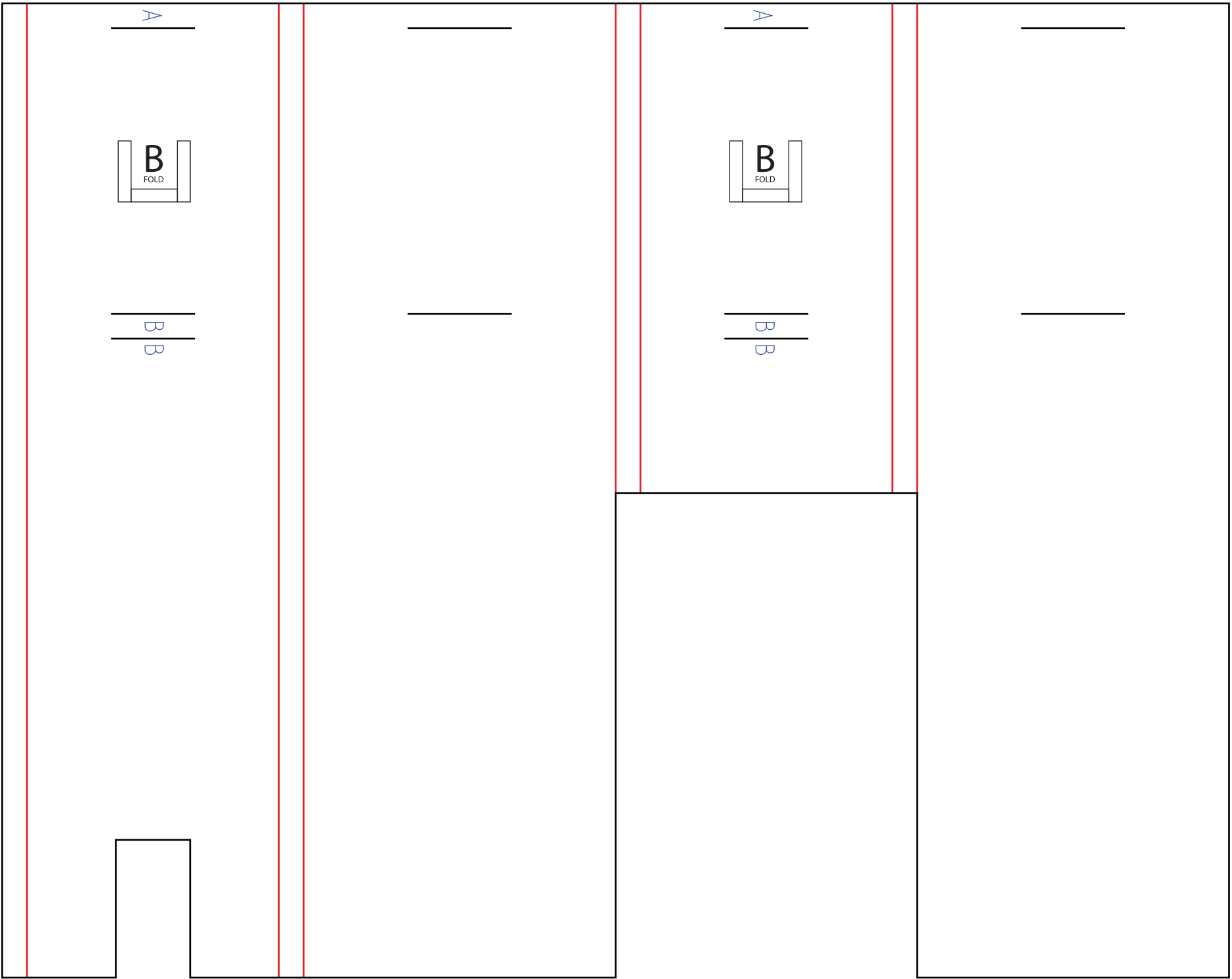

Copyright ©2021 13thSquadron. All Rights Reserved.  
Commercial use of our plans are prohibited.

Copyright ©2021 13thSquadron. All Rights Reserved.  
Commercial use of our plans are prohibited.

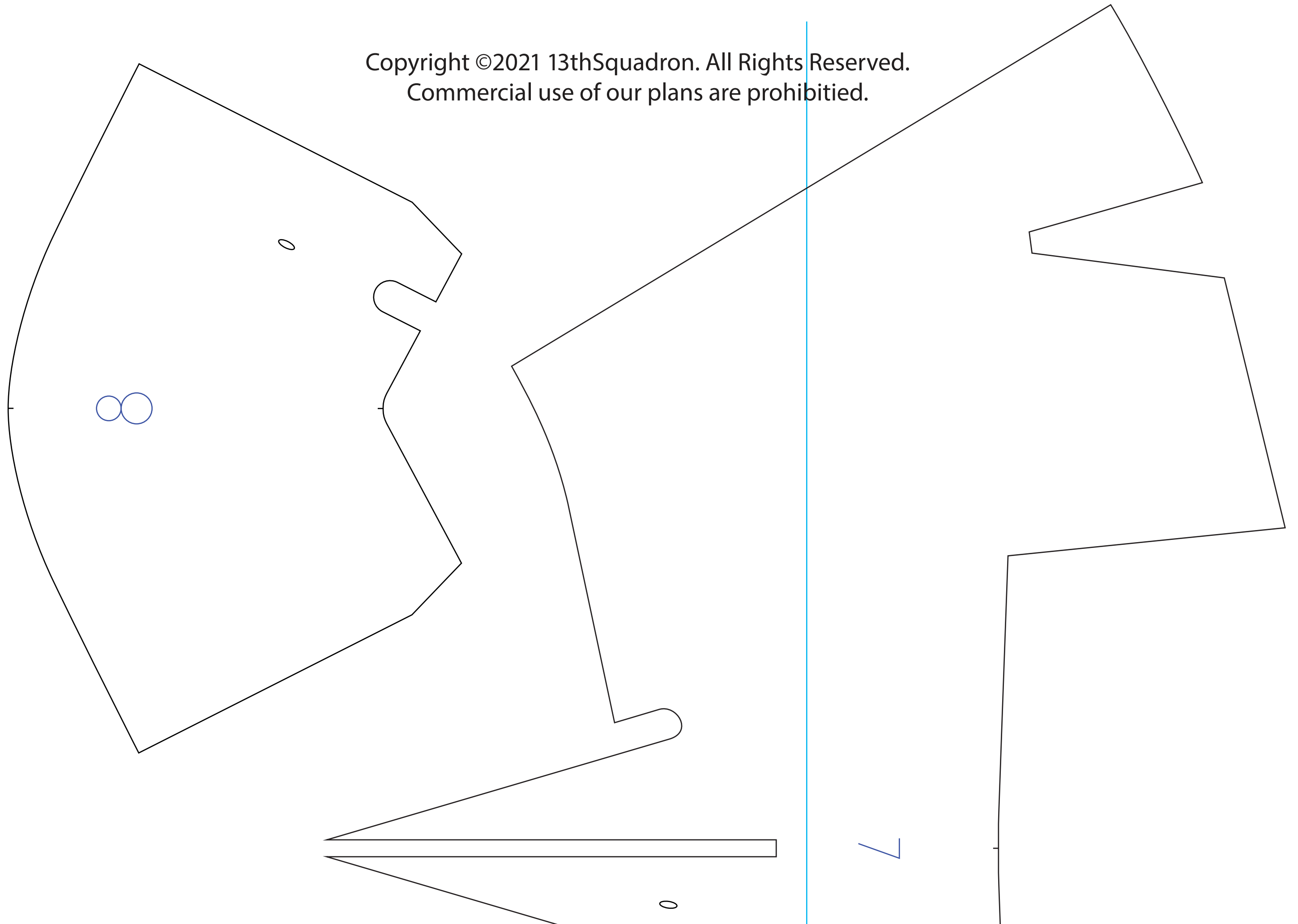

Copyright ©2021 13thSquadron. All Rights Reserved.  
Commercial use of our plans are prohibited.



Servo Doublers

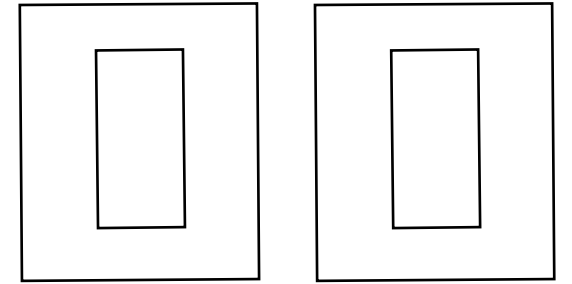

21"

Flop this pattern for the other side

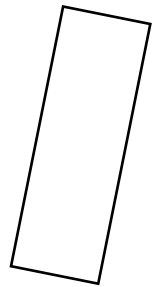

Peel the paper off on the inside of this area so you can curve the airfoil to the leading edge.

Cut a 45° Degree Bevel between the top wing and the lower wing before gluing.

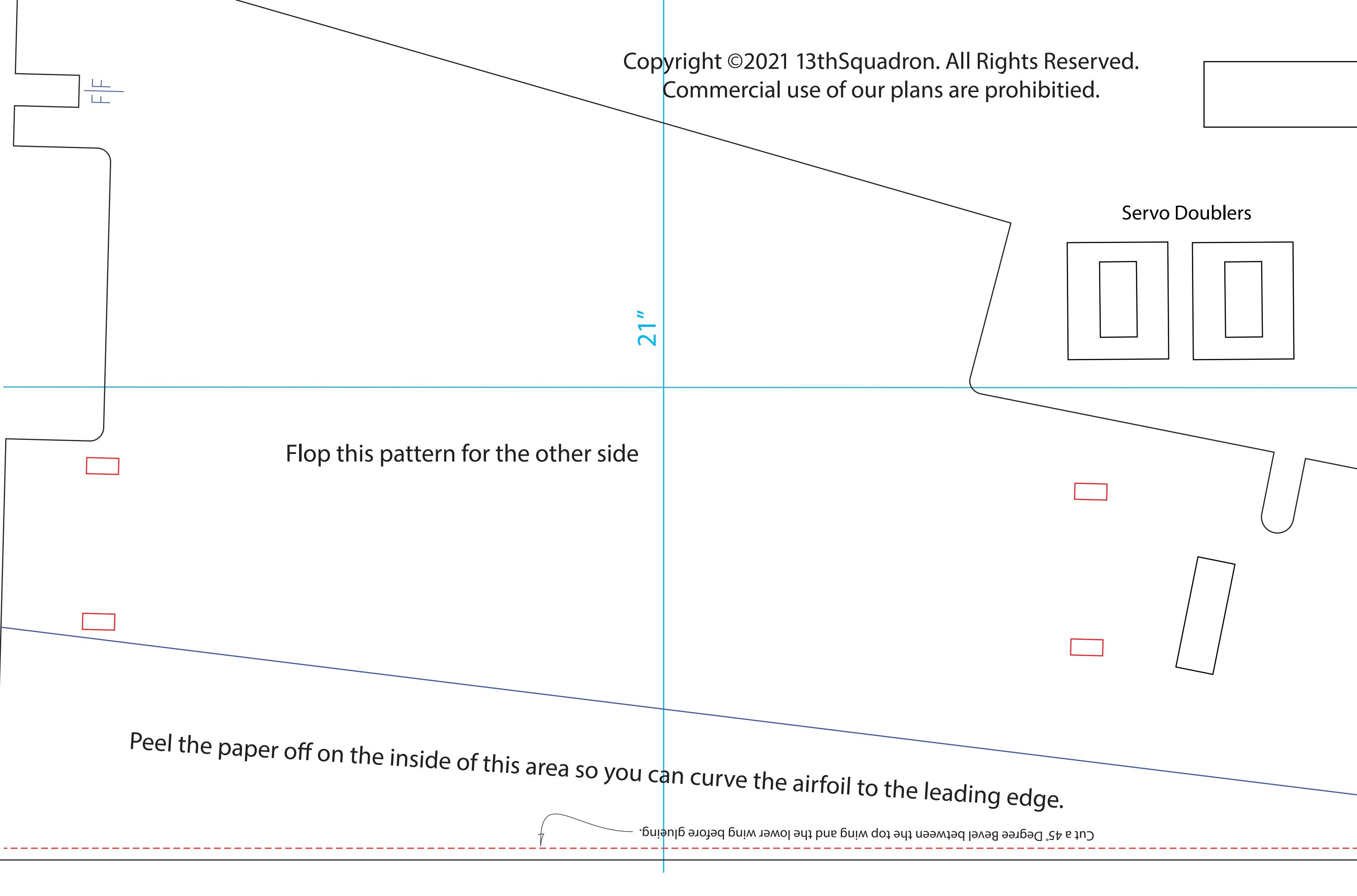

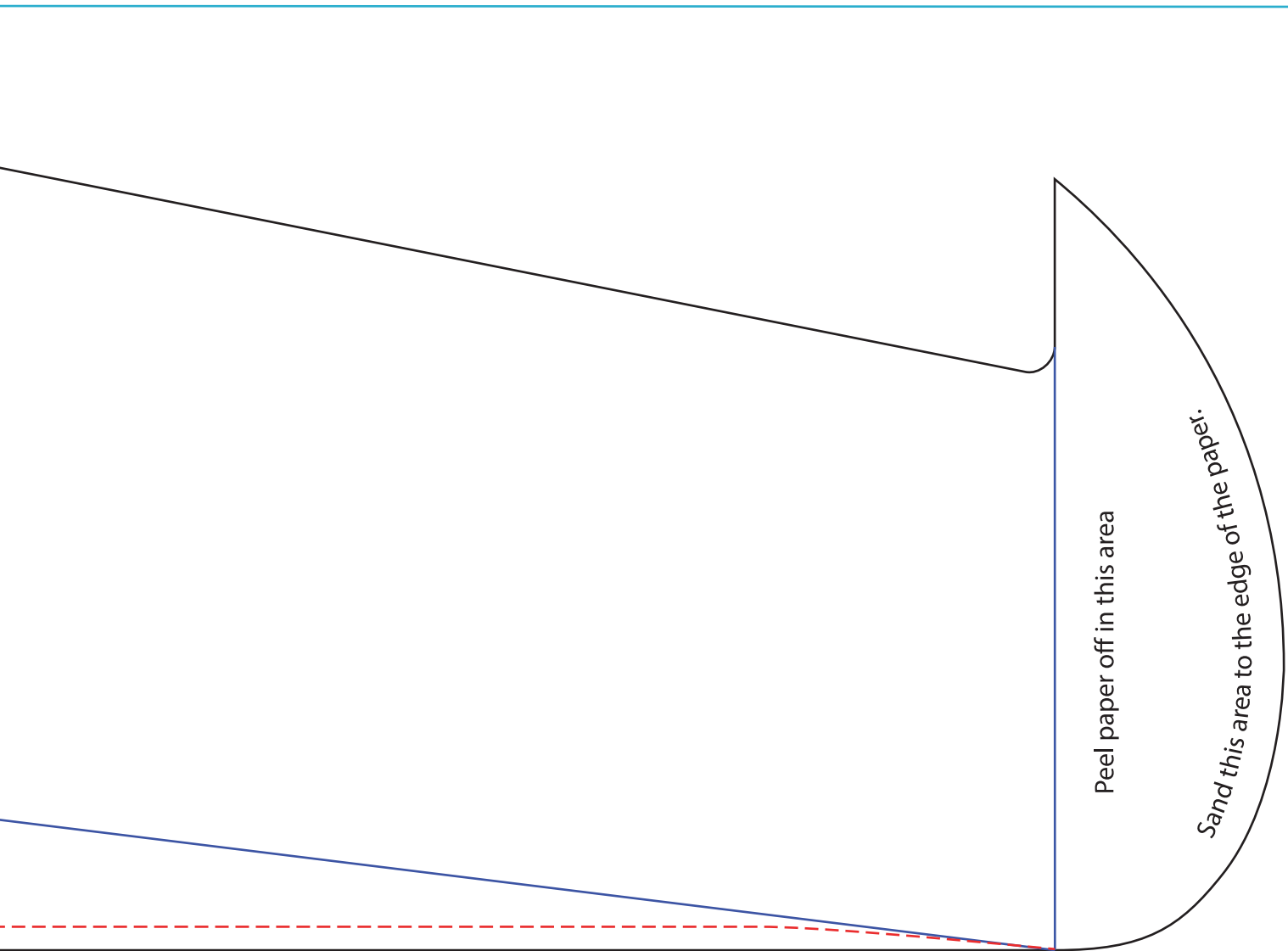
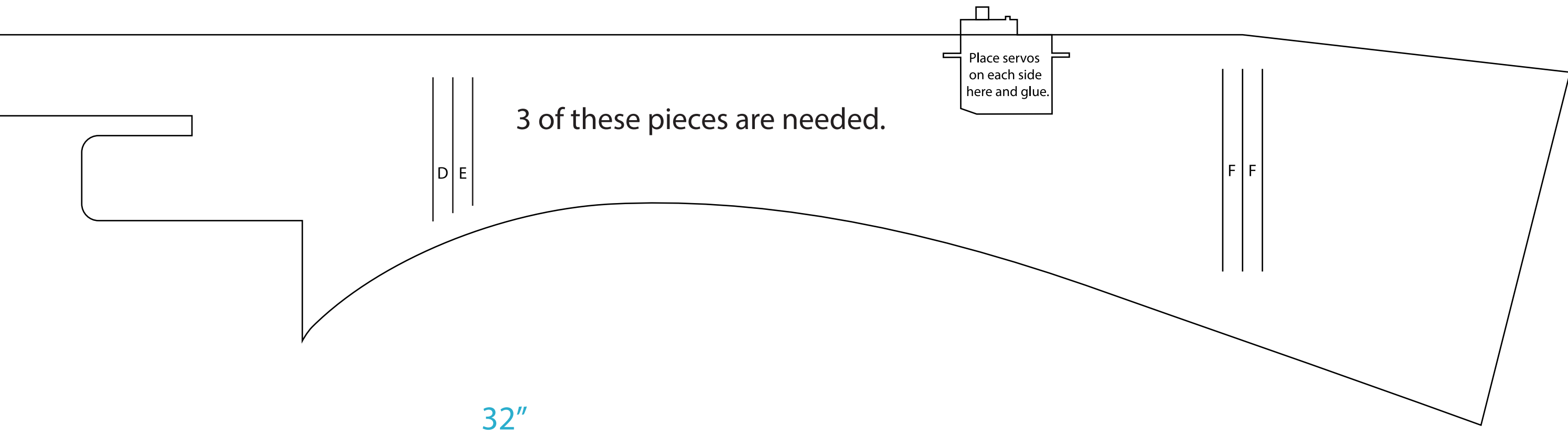

Copyright ©2021 13thSquadron. All Rights Reserved.  
Commercial use of our plans are prohibited.

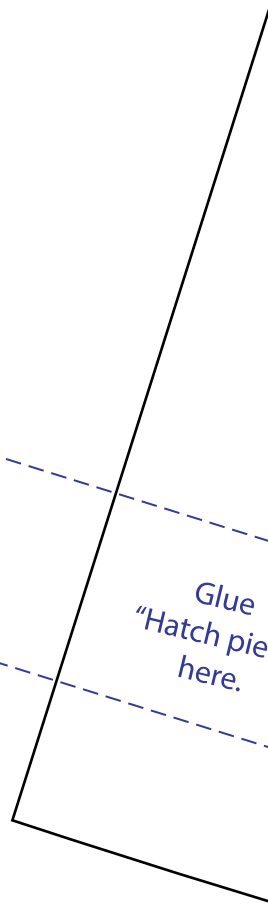

This piece is used for the hatch

This piece is used for the hatch

Exhaust Port Location  
Do not glue this one

Exhaust Port Location  
glue this one

Glue  
"Hatch piece"  
here.

This will be the hinge for the hatch.

5

21"

ce"

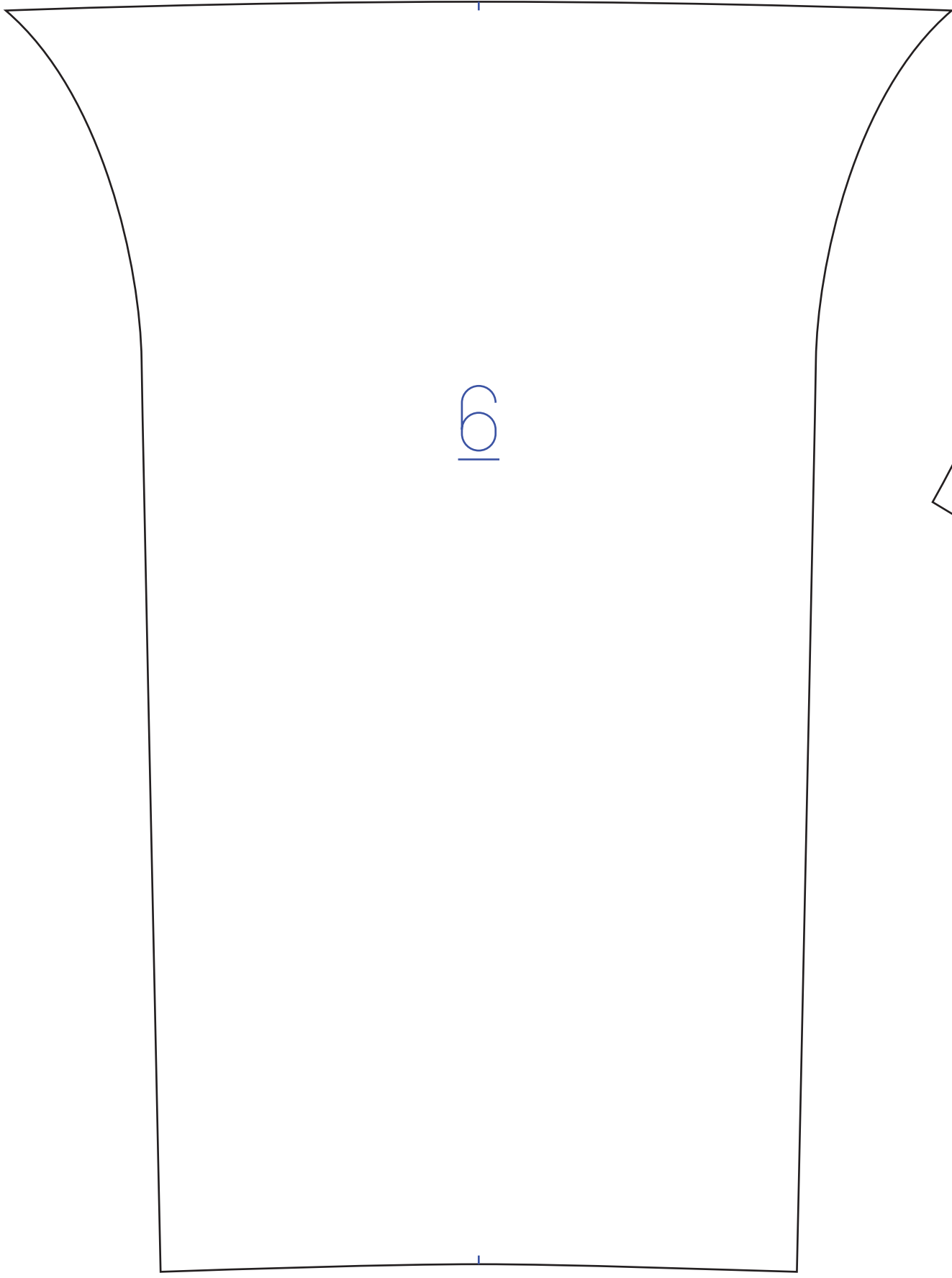

161

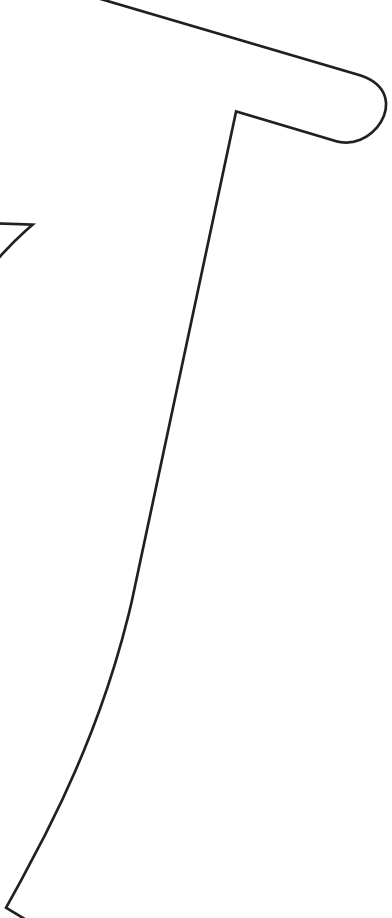

21"

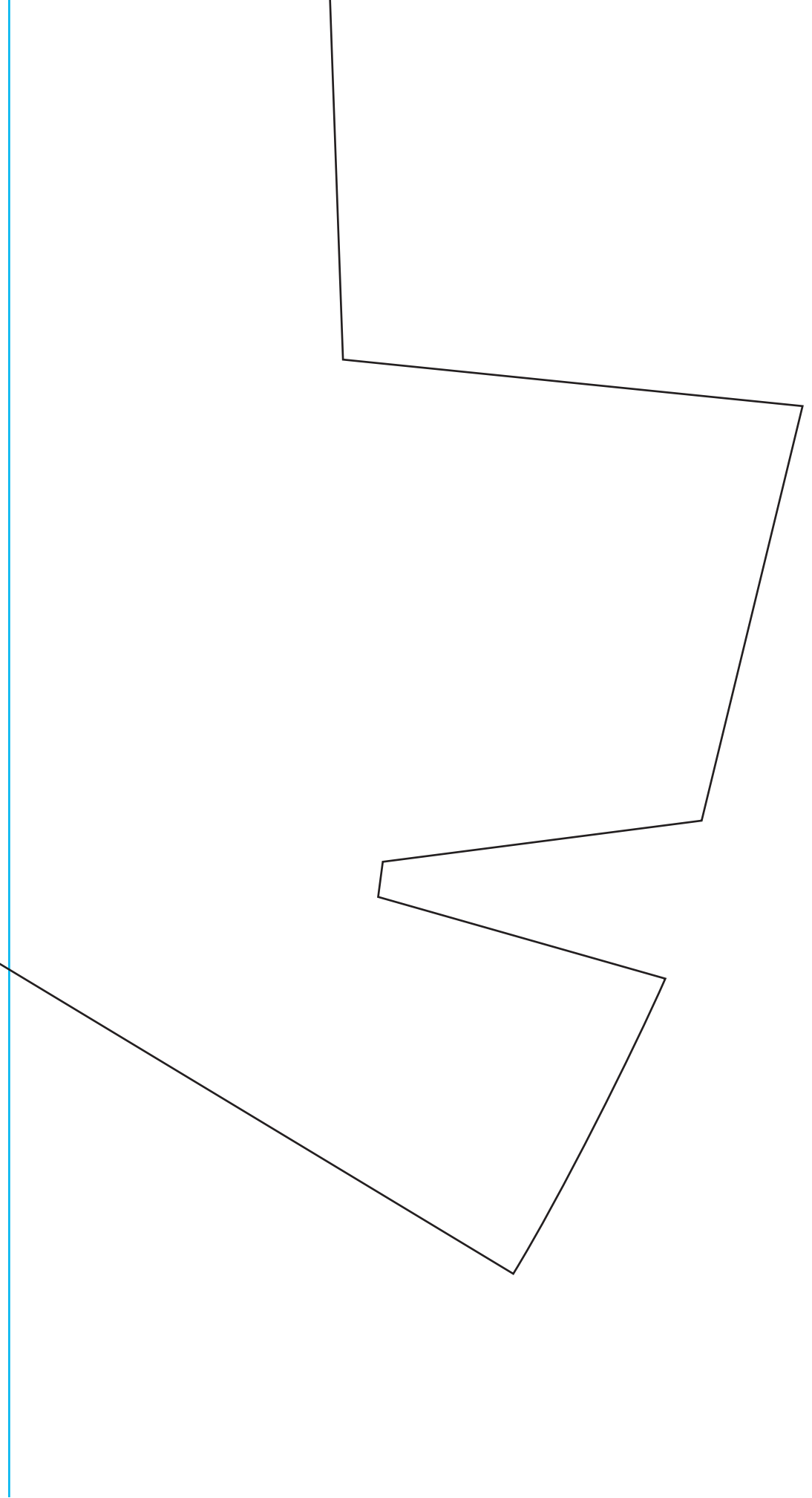



Cut a 45° Degree Bevel between the top wing and the lower wing before glueing.

## How to do the Leading Edges of the wings and elevator.

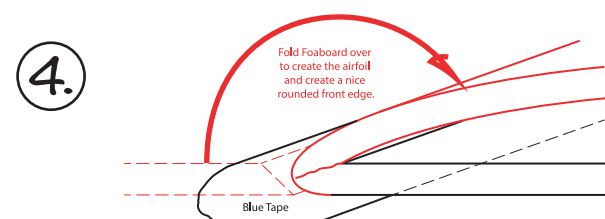
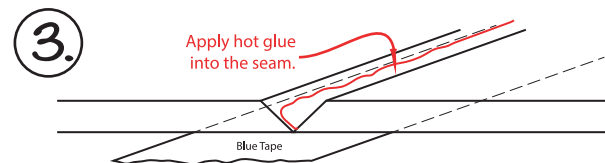
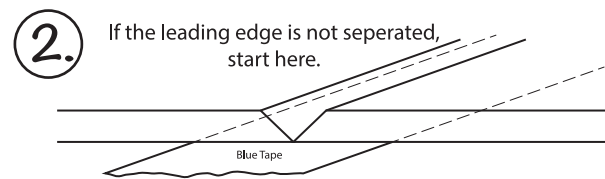
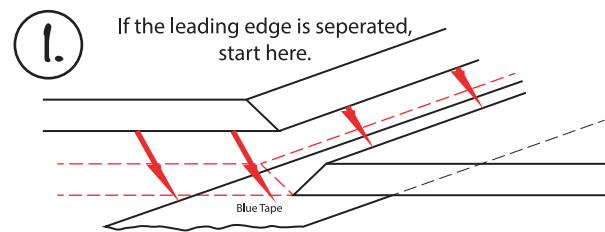

Flop this pattern for the other side

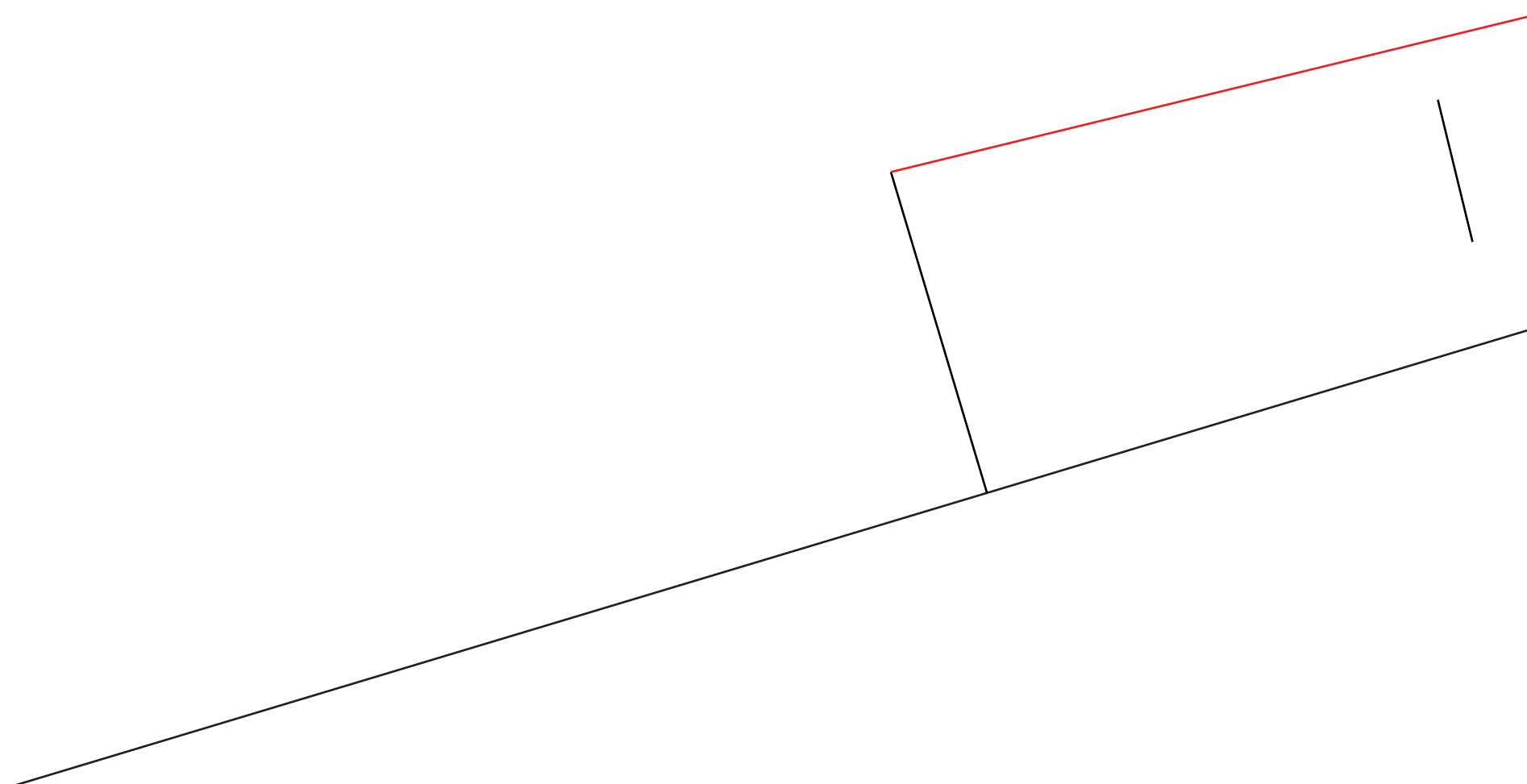

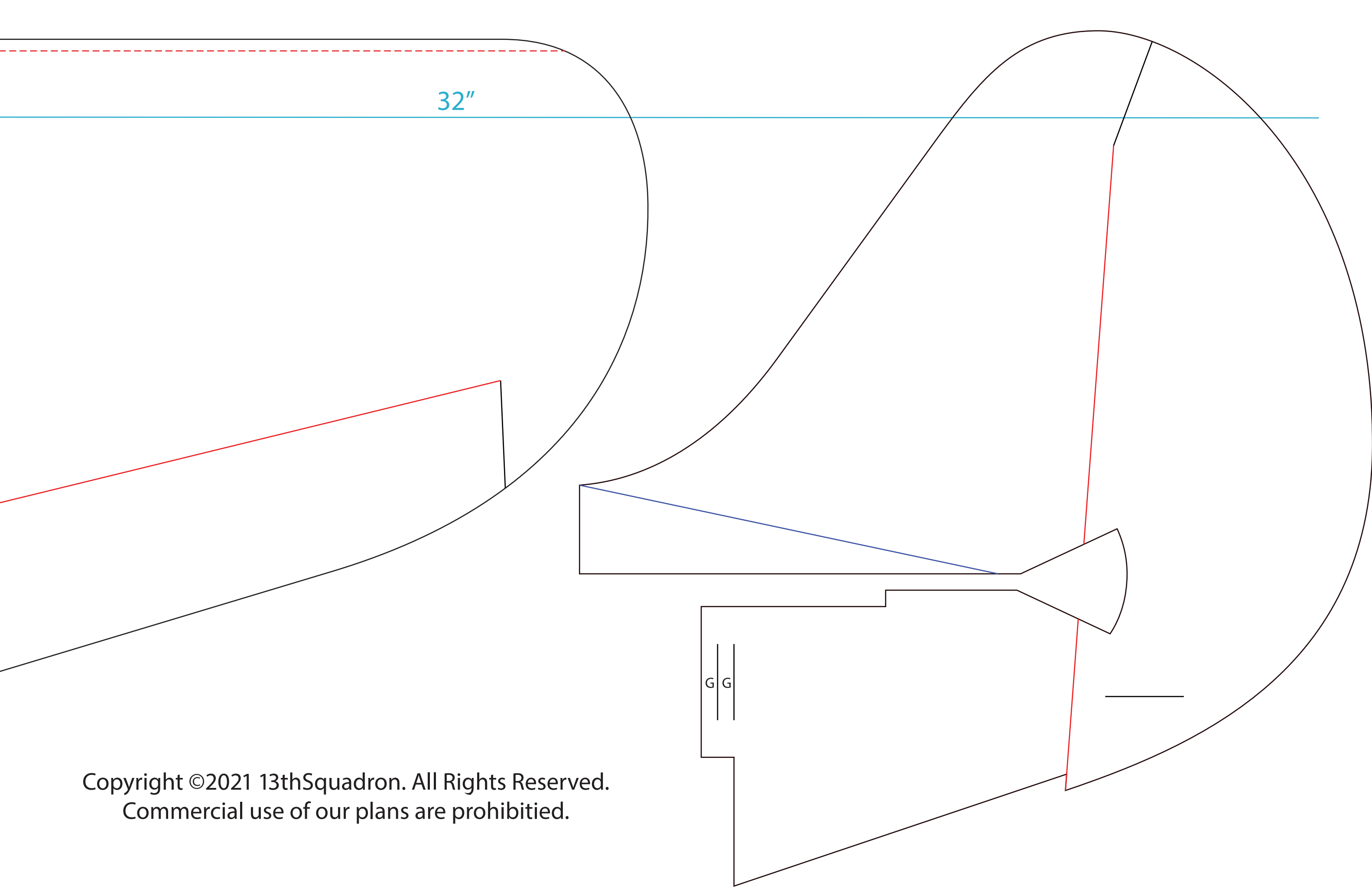

32"

G G

Copyright ©2021 13thSquadron. All Rights Reserved.  
Commercial use of our plans are prohibited.

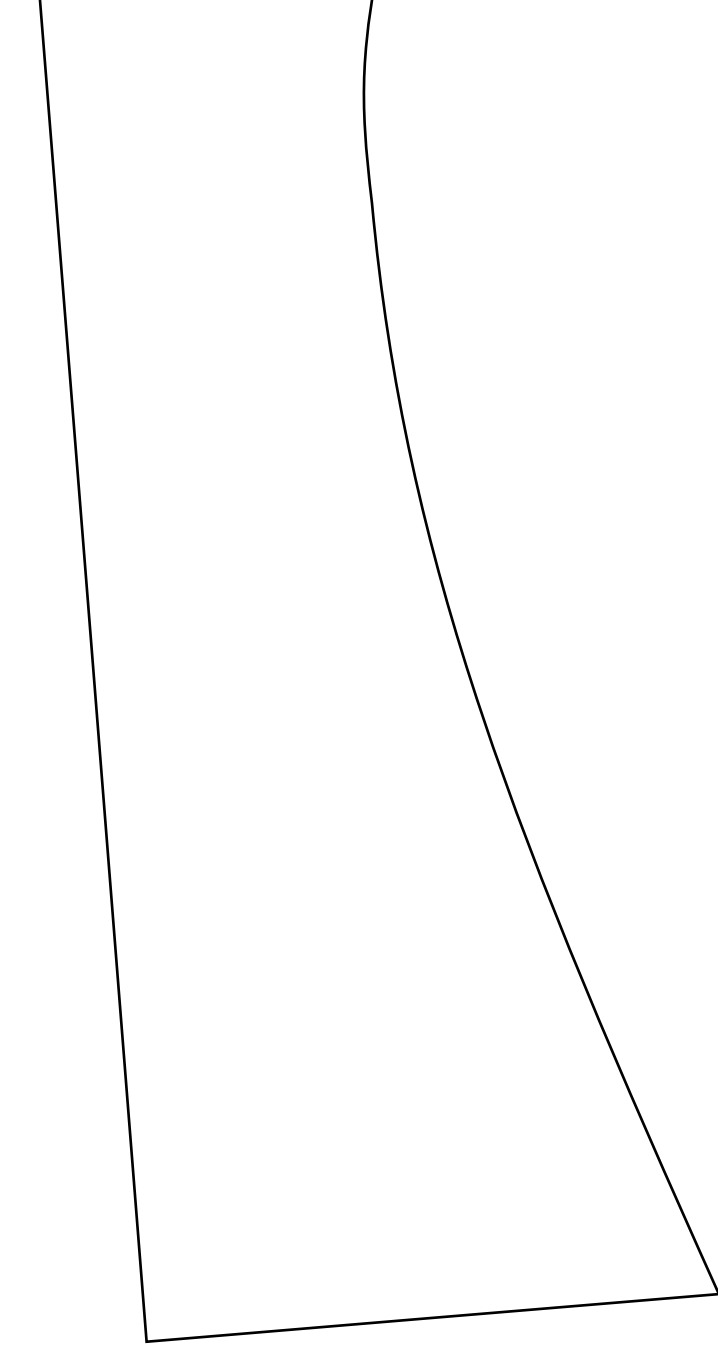
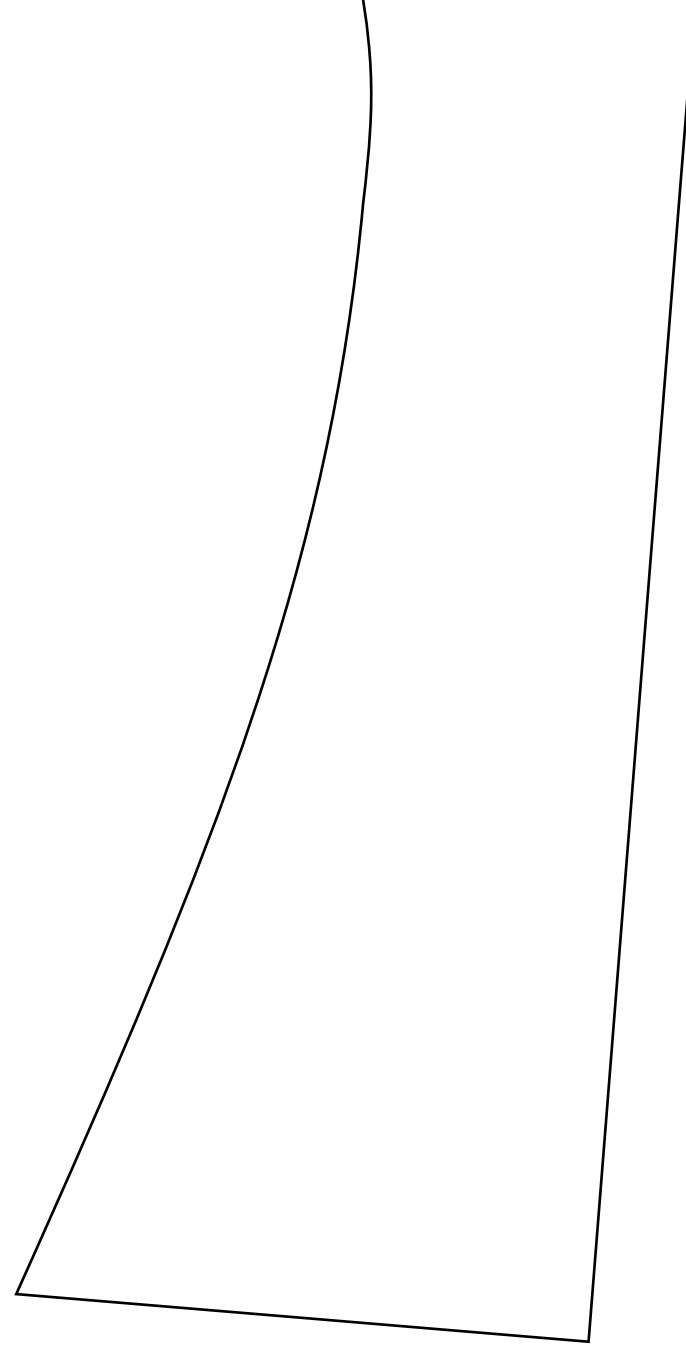

Follow the guide below to help you assemble the Helldiver. Please note that we only made one of these planes so far so keep in mind that some of the exterior "skin" pieces might not fit perfectly. We always recommend to "dry fit" the pieces first before glueing them into place. If they do not fit perfectly, we would suggest to make the adjustments accordingly and replace it with the new piece that you made.

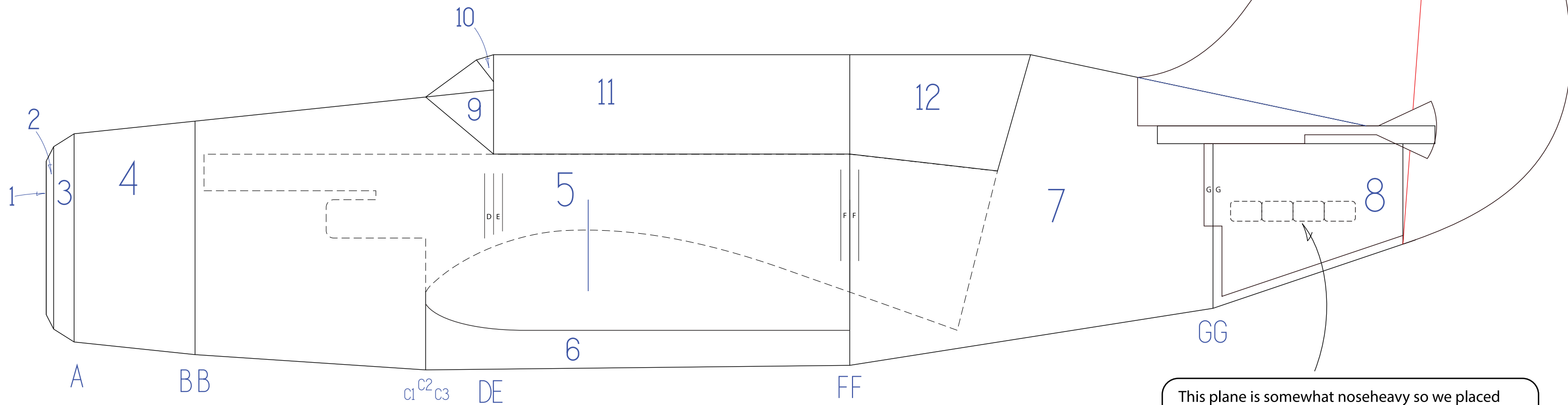

This plane is somewhat noseheavy so we placed four "Tire weights" here on each side to make the CG work. You might want to figure out the CG before glueing this piece on.

Each weight weighs .25 oz = 2 oz total of tailweight.

Copyright ©2021 13thSquadron. All Rights Reserved.  
Commercial use of our plans are prohibited.

21"

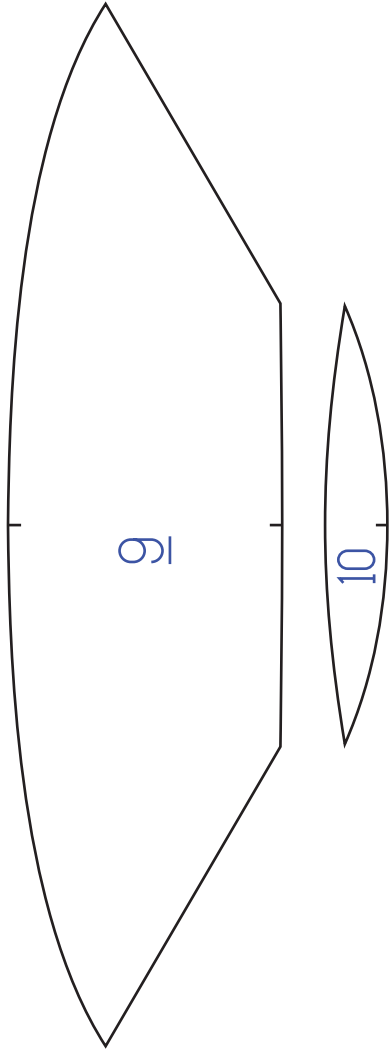

9

10

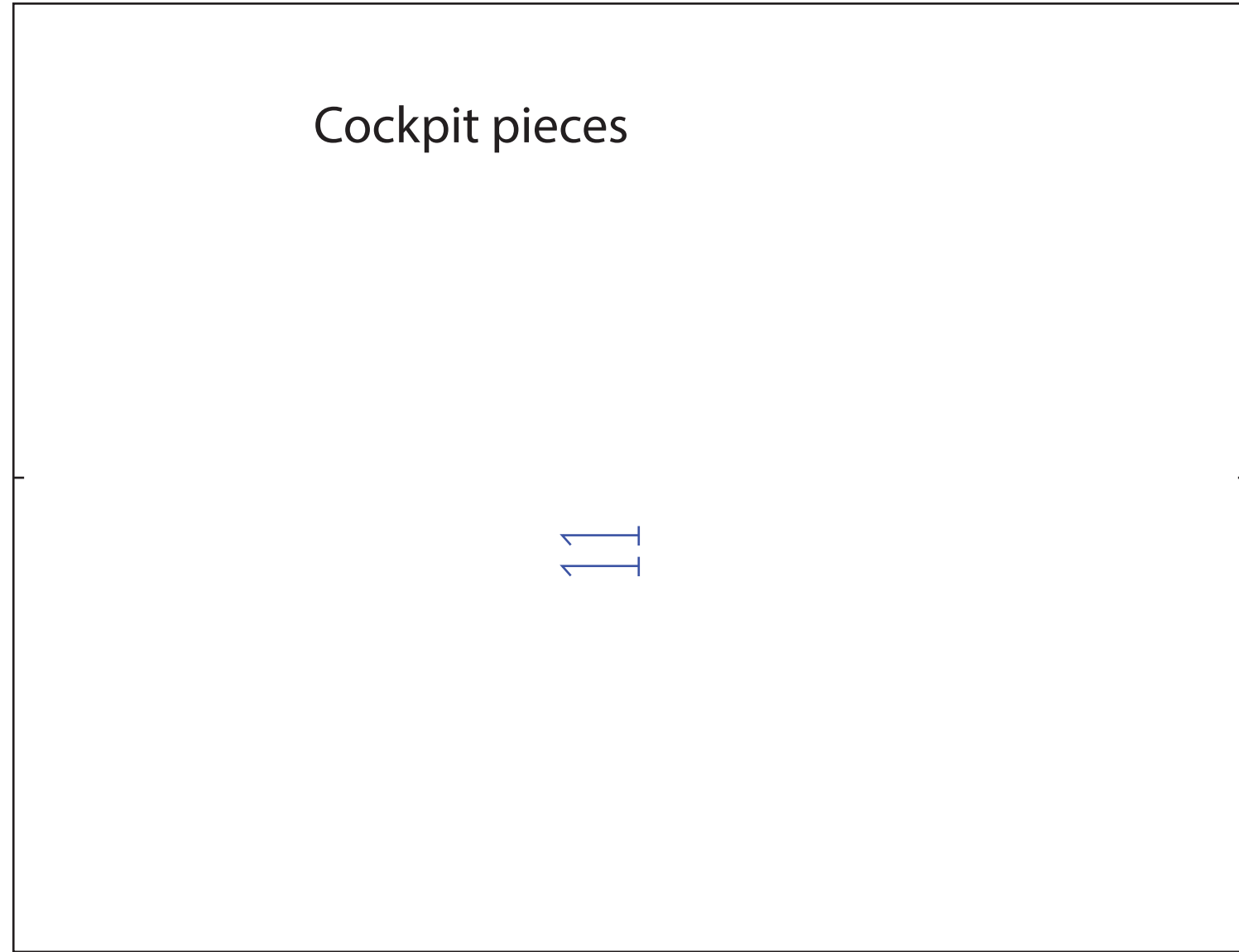

Cockpit pieces

11

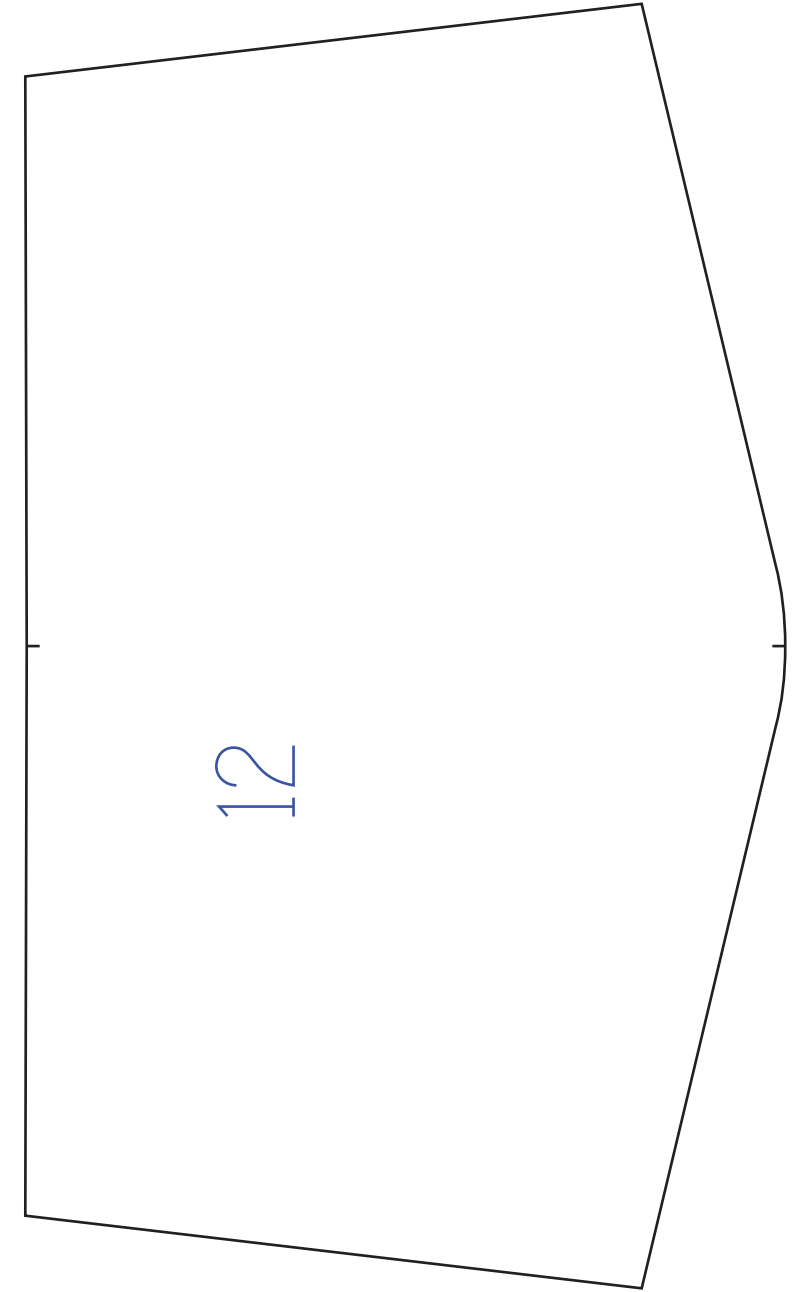

12

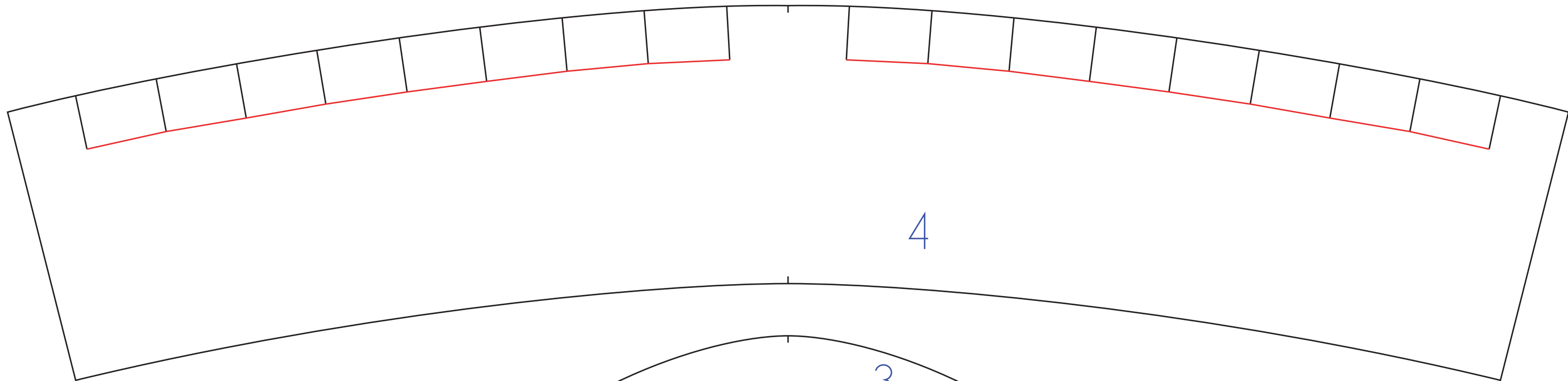

4

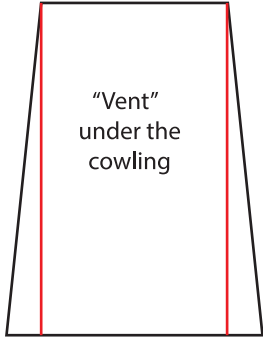

"Vent"  
under the  
cowling

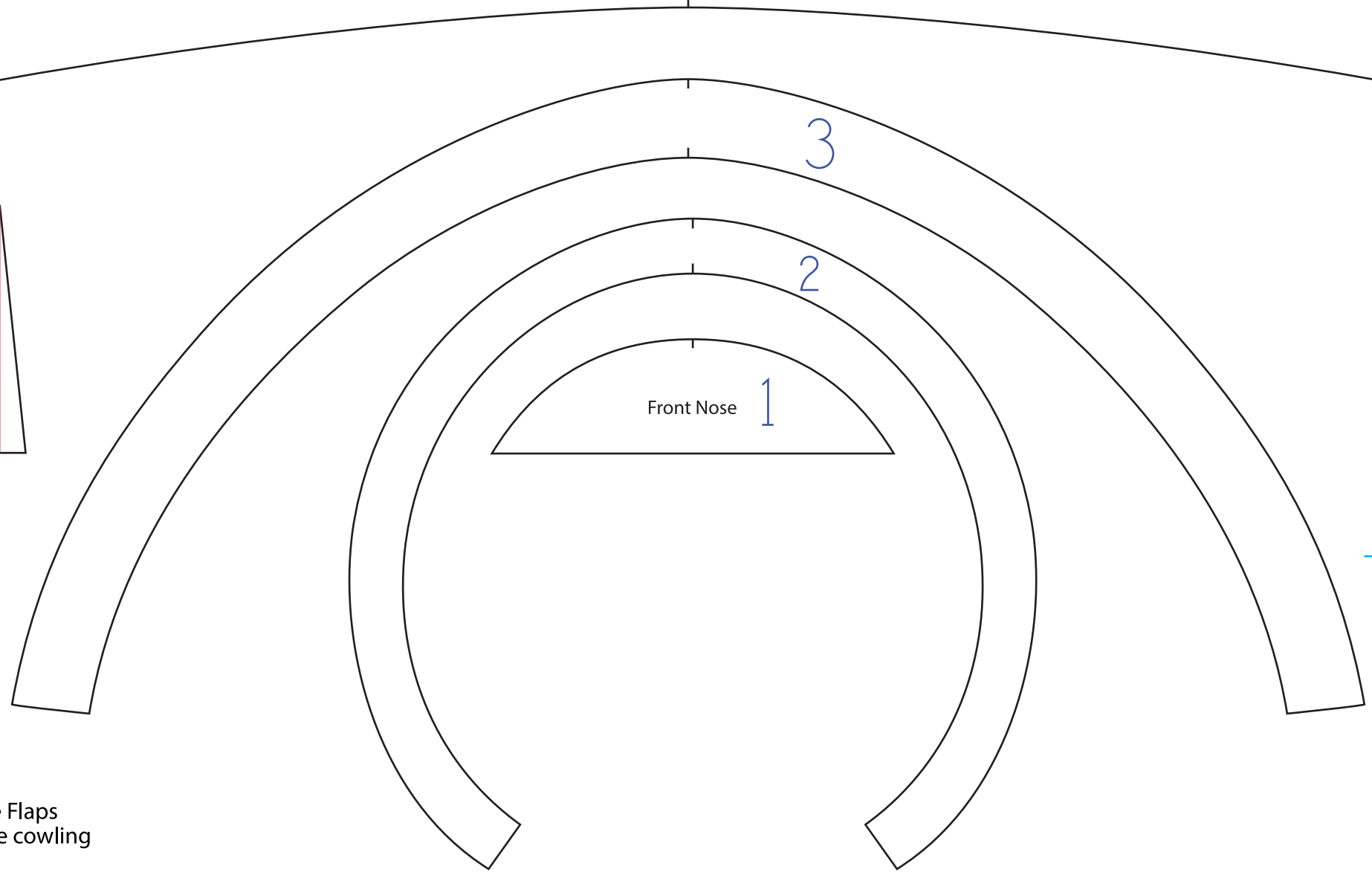

Front Nose

1

2

3

Engine Flaps  
under the cowling

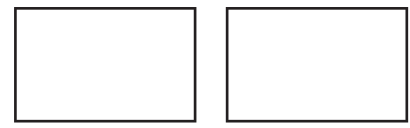

Copyright ©2021 13thSquadron. All Rights Reserved.  
Commercial use of our plans are prohibited.

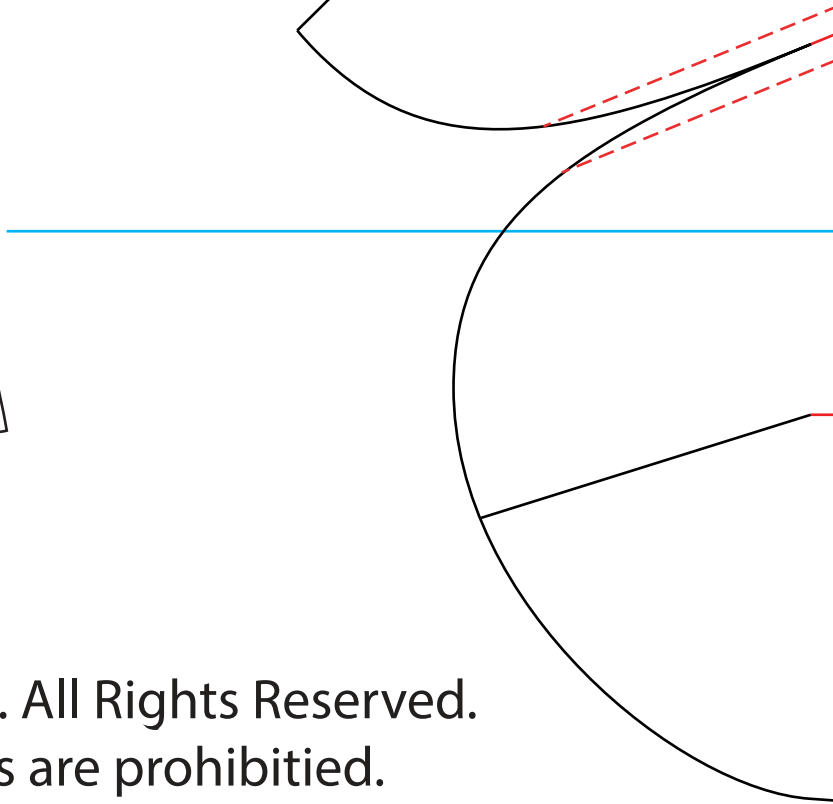

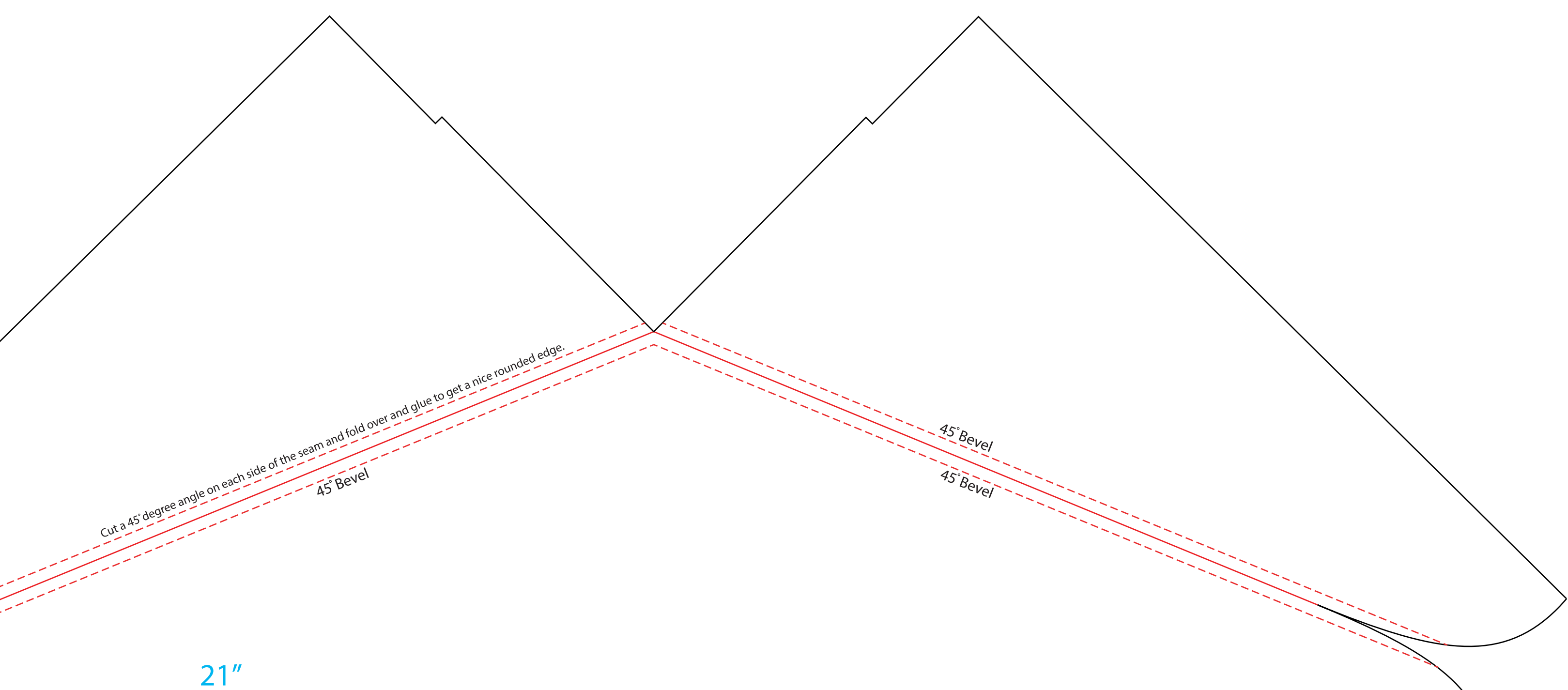

21"

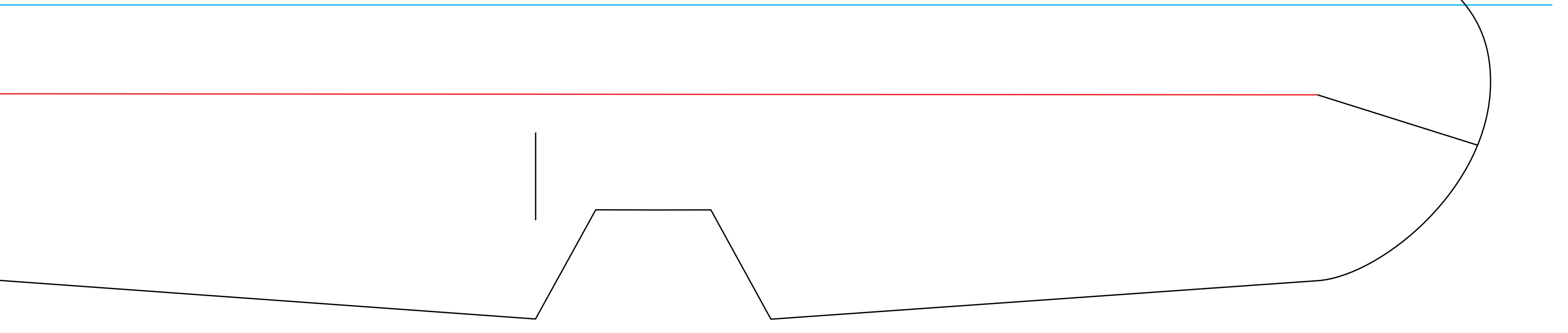

Fuselage Insignia



Wing Insignia

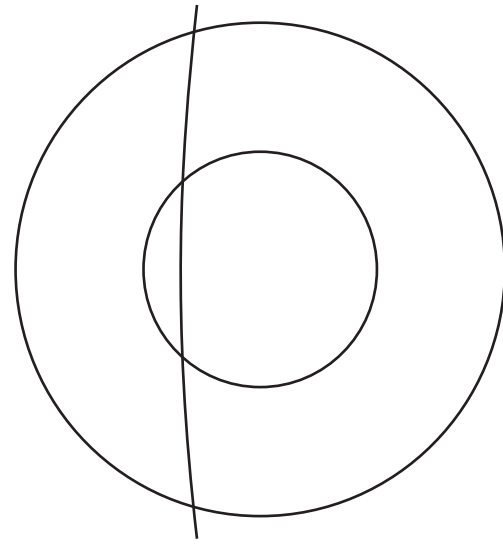
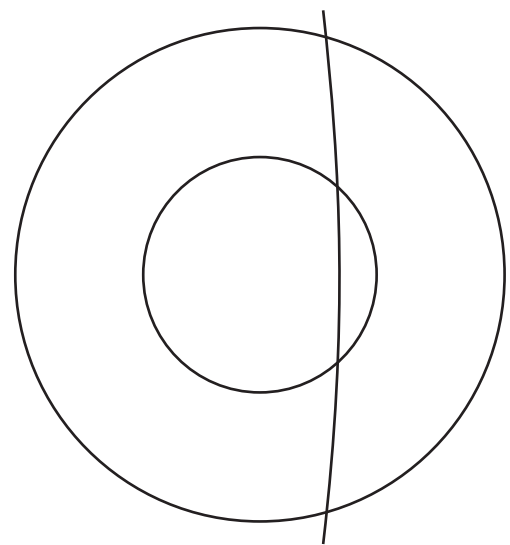

**0123456789**

Landing Gear Numbers

**0123456789**

Front Cowling Numbers

**0123456789**

Vertical Stab Numbers