

Flip this wing pattern over
for the other side.

32"

3/32" Hobby Plywood for spar support

3/32" Hobby Plywood for spar support

32"

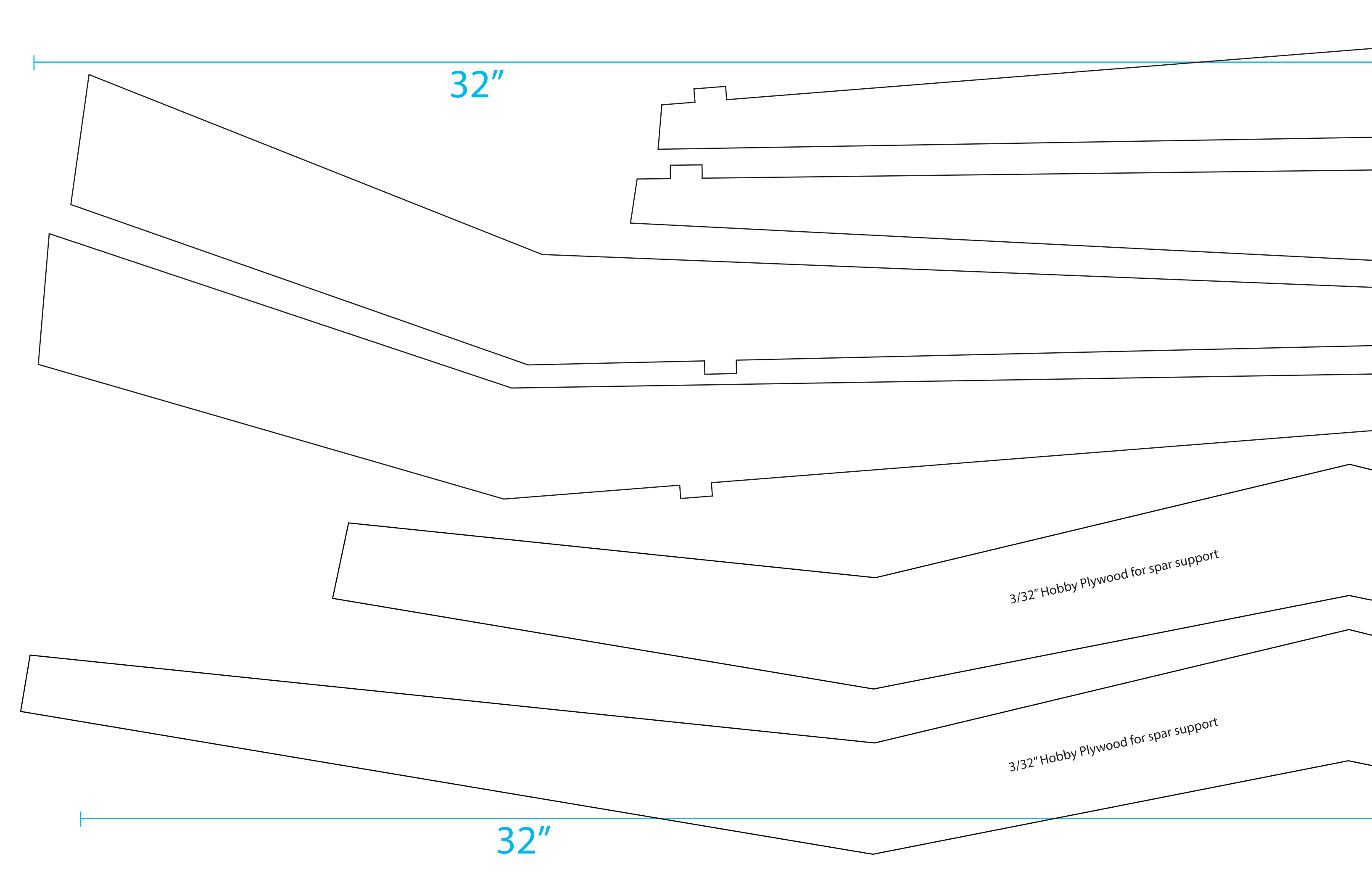

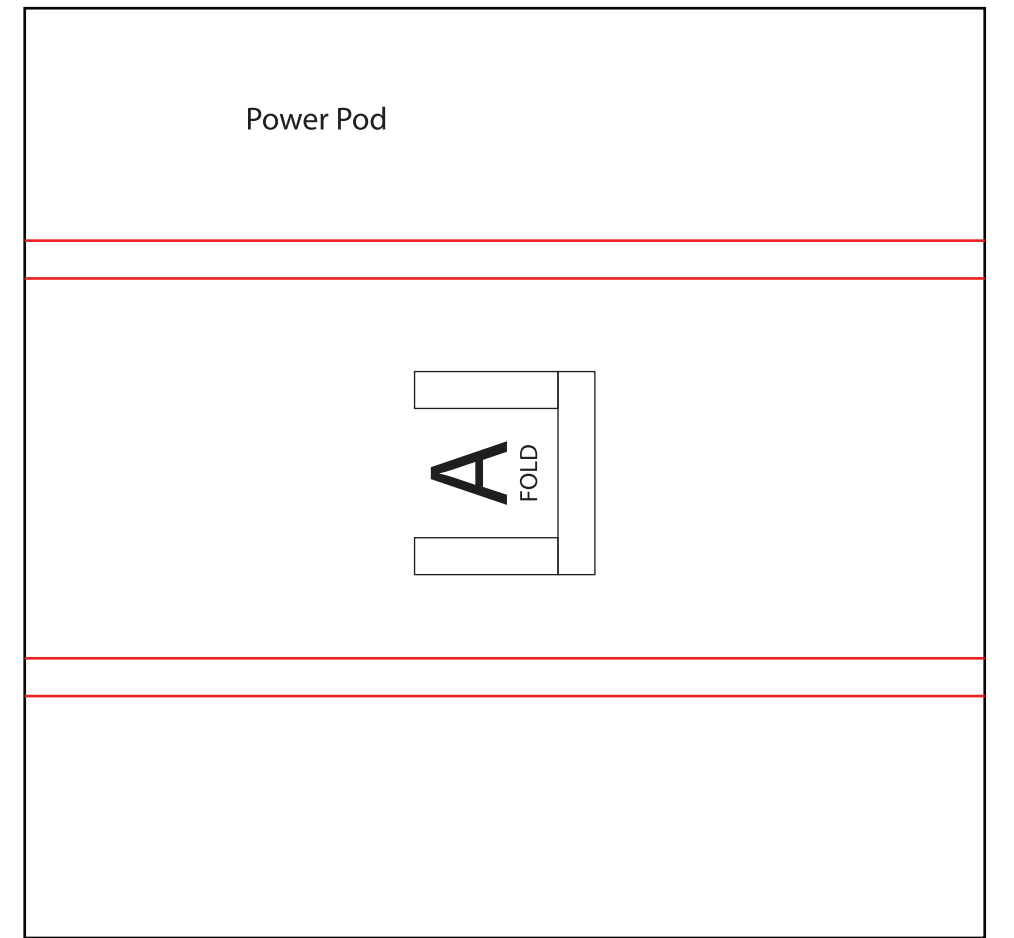
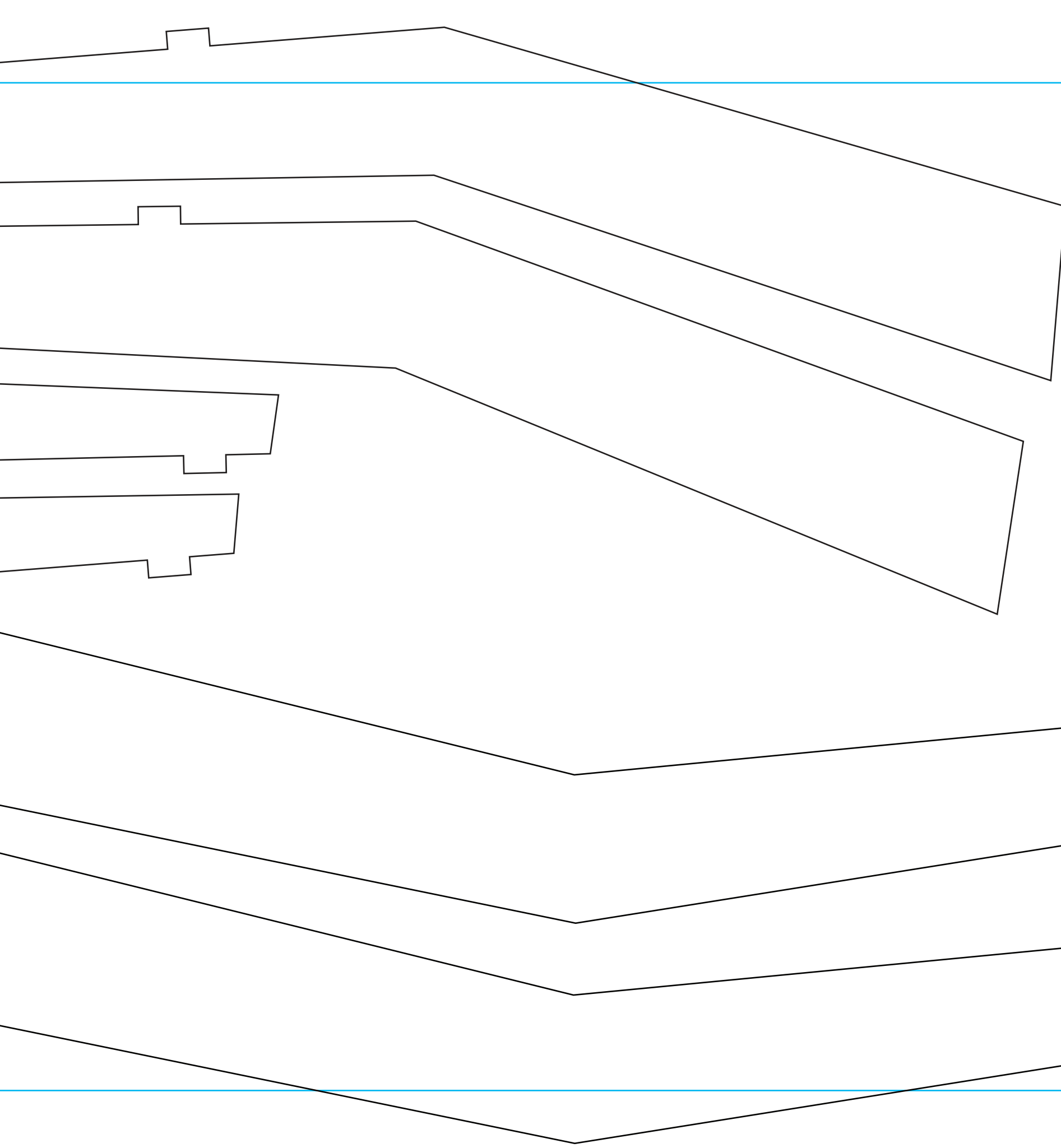

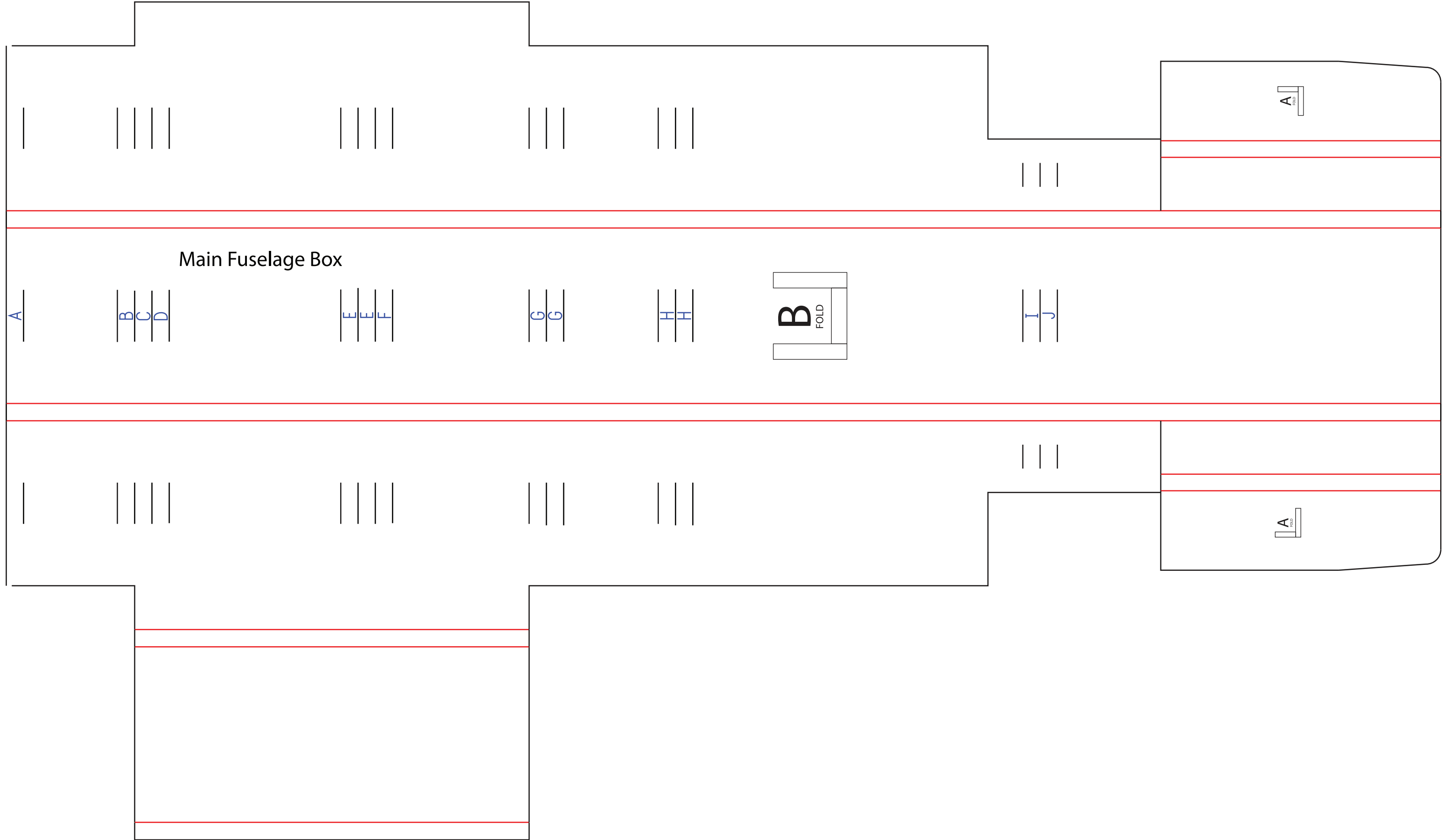

Flip this wing pattern over
for the other side.

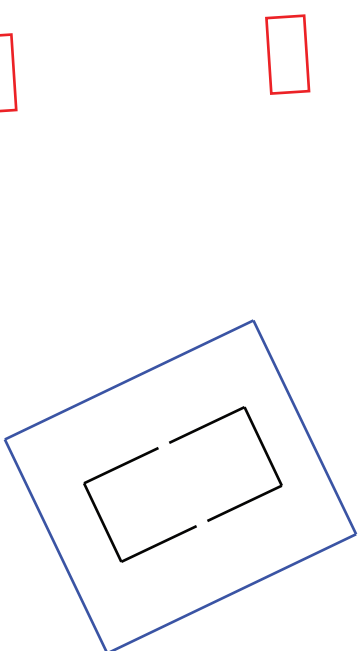

21"

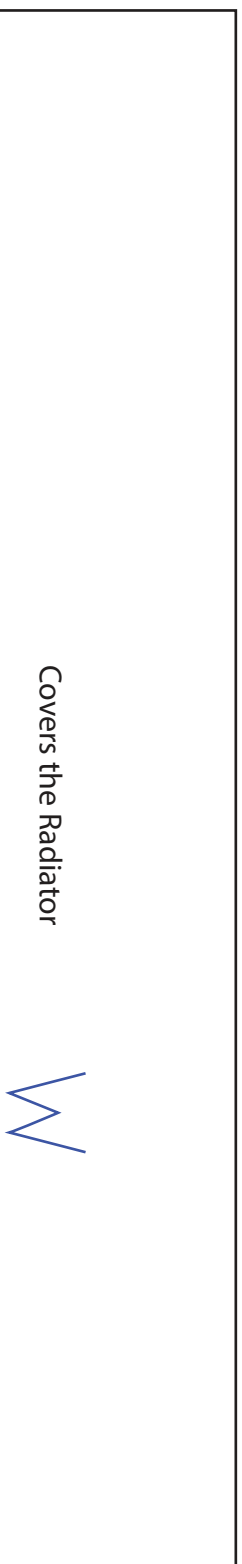
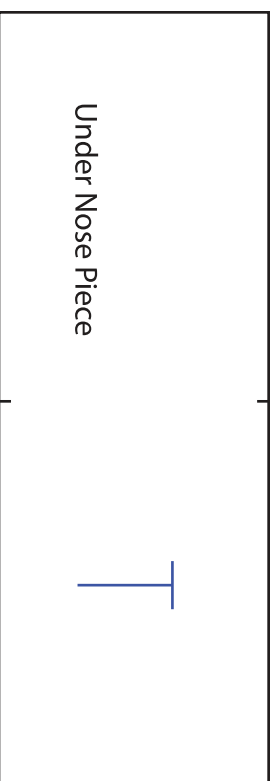

21"

32"

Flip this wing pattern over
for the other side.

Elevator Decoration Pieces

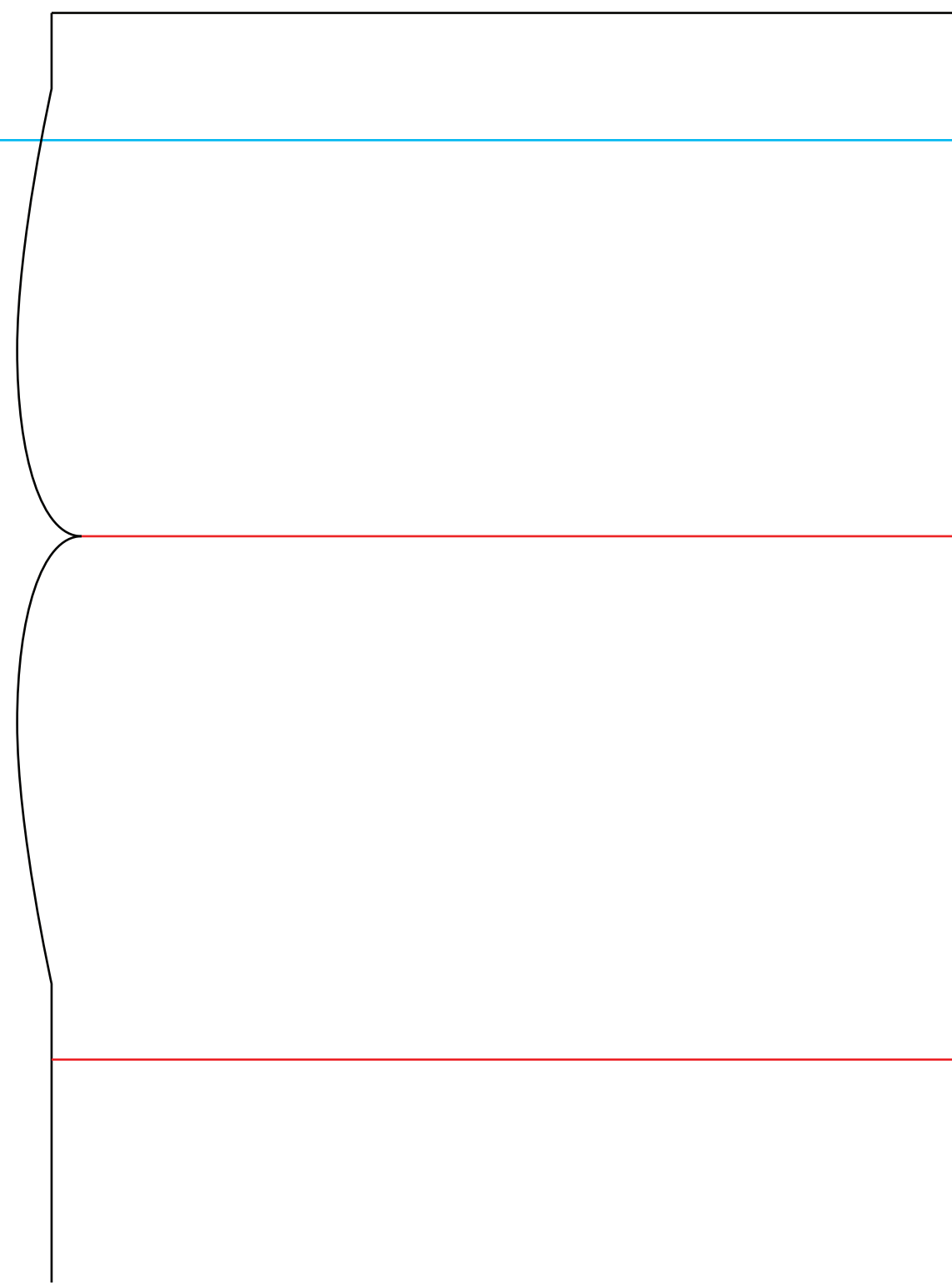
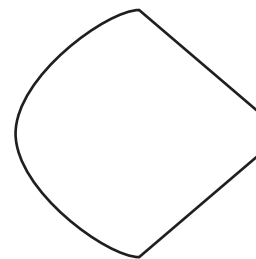
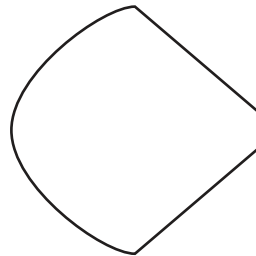

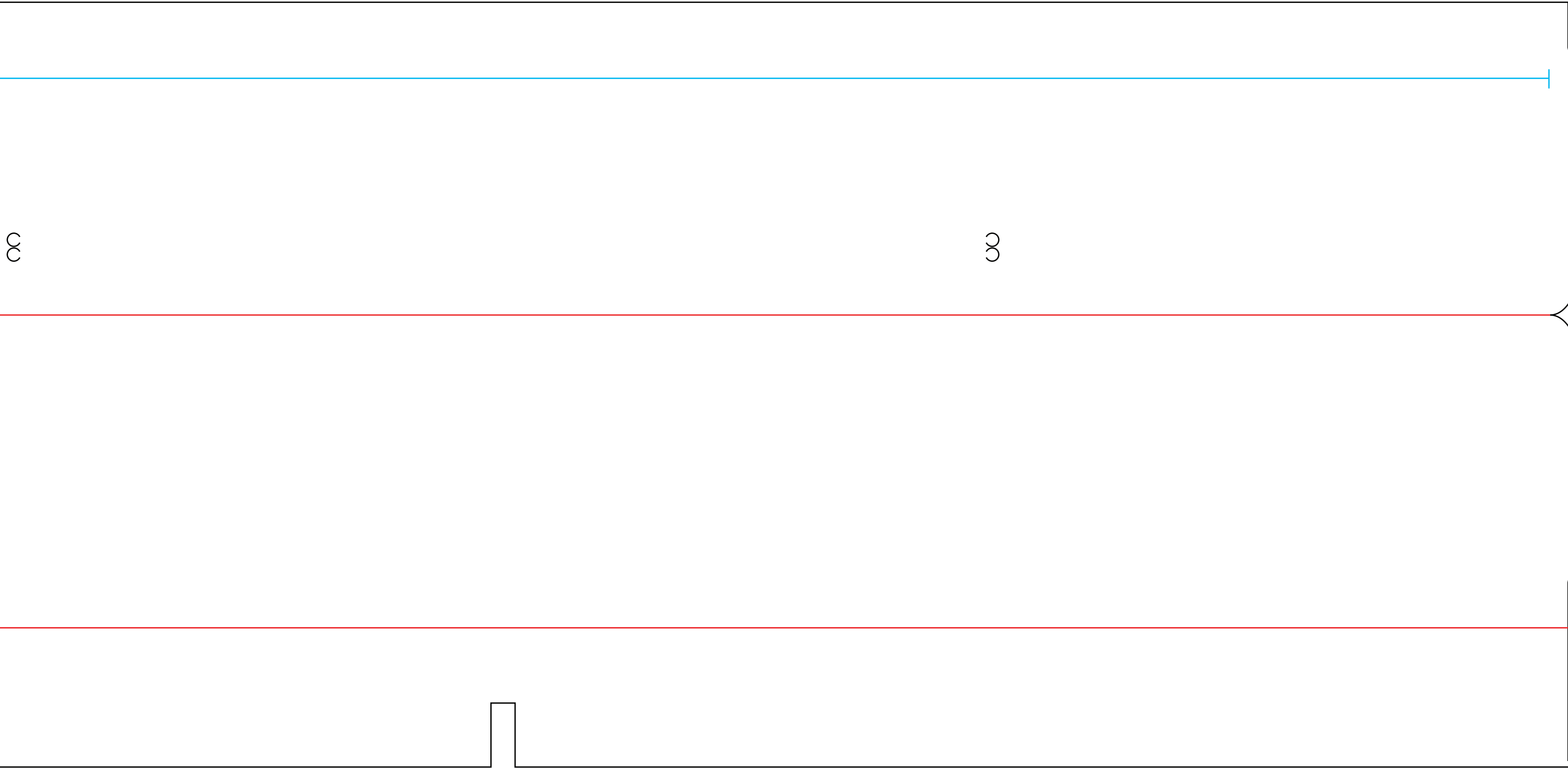

Copyright ©2020 13thSquadron. All Rights Reserved.
Commercial use of our plans are prohibited.

"C" fold here. Cut out the foam, leave the paper, fold over and glue.

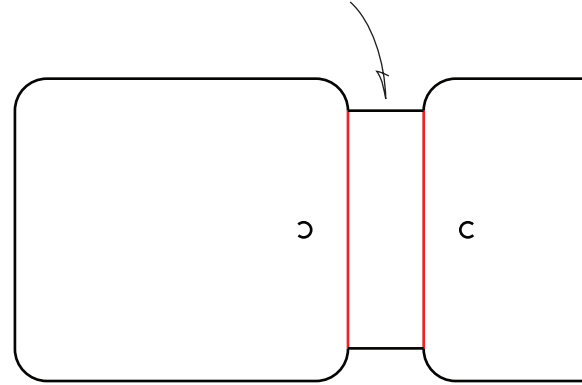

Hatch piece on the bottom

Do not peel off paper on either side of this hatch piece.

Bevel to dashed line on other side of foamboard

Bevel to dashed line on other side of foamboard

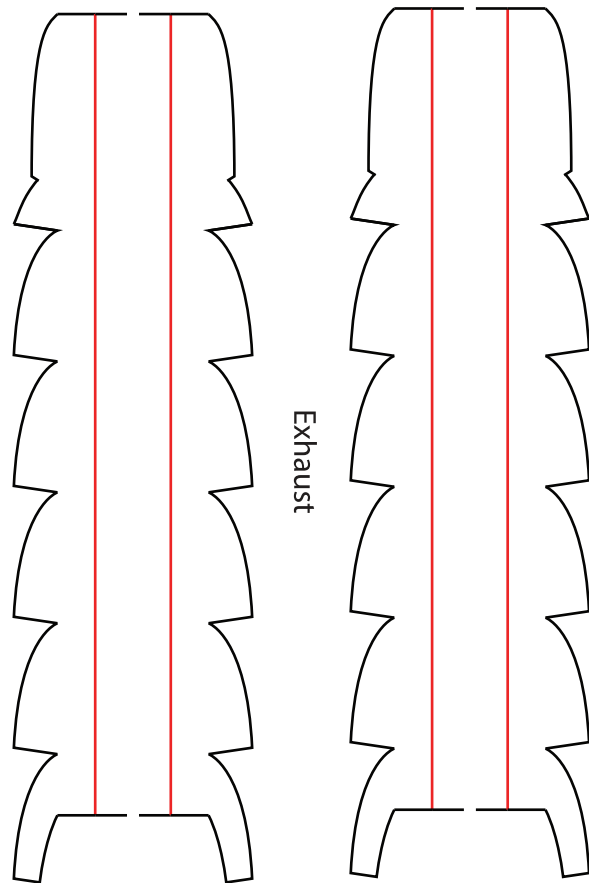

Hatch molded piece

Peel off paper on one side and glue to the other hatch piece. It's made longer on each side to give you leverage when you glue it up the side of the other hatch piece.

Once it is glued, trim the excess foam. See reference photos on 13thsquadron.com

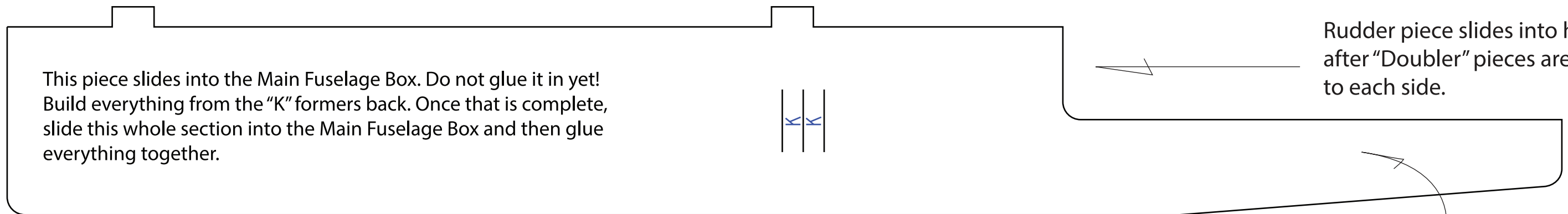
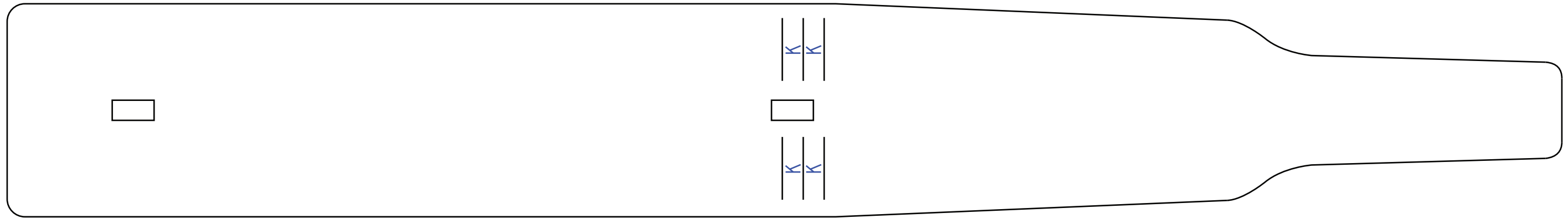

This piece slides into the Main Fuselage Box. Do not glue it in yet! Build everything from the "K" formers back. Once that is complete, slide this whole section into the Main Fuselage Box and then glue everything together.

Rudder piece slides into here after "Doubler" pieces are glued to each side.

Doubler pieces go here.

ATTENTION

Please keep in mind that these are Beta Plans. We haven't made a second plane yet to find out if all of these parts are correct but these are the pieces we used to make our Stuka. We assume that if you are challenging yourself to make this plane, you probably have the knowledge to fix any imperfections we haven't figured out yet. Good luck with the build and we hope you enjoy the plane!

Doubler

Doubler

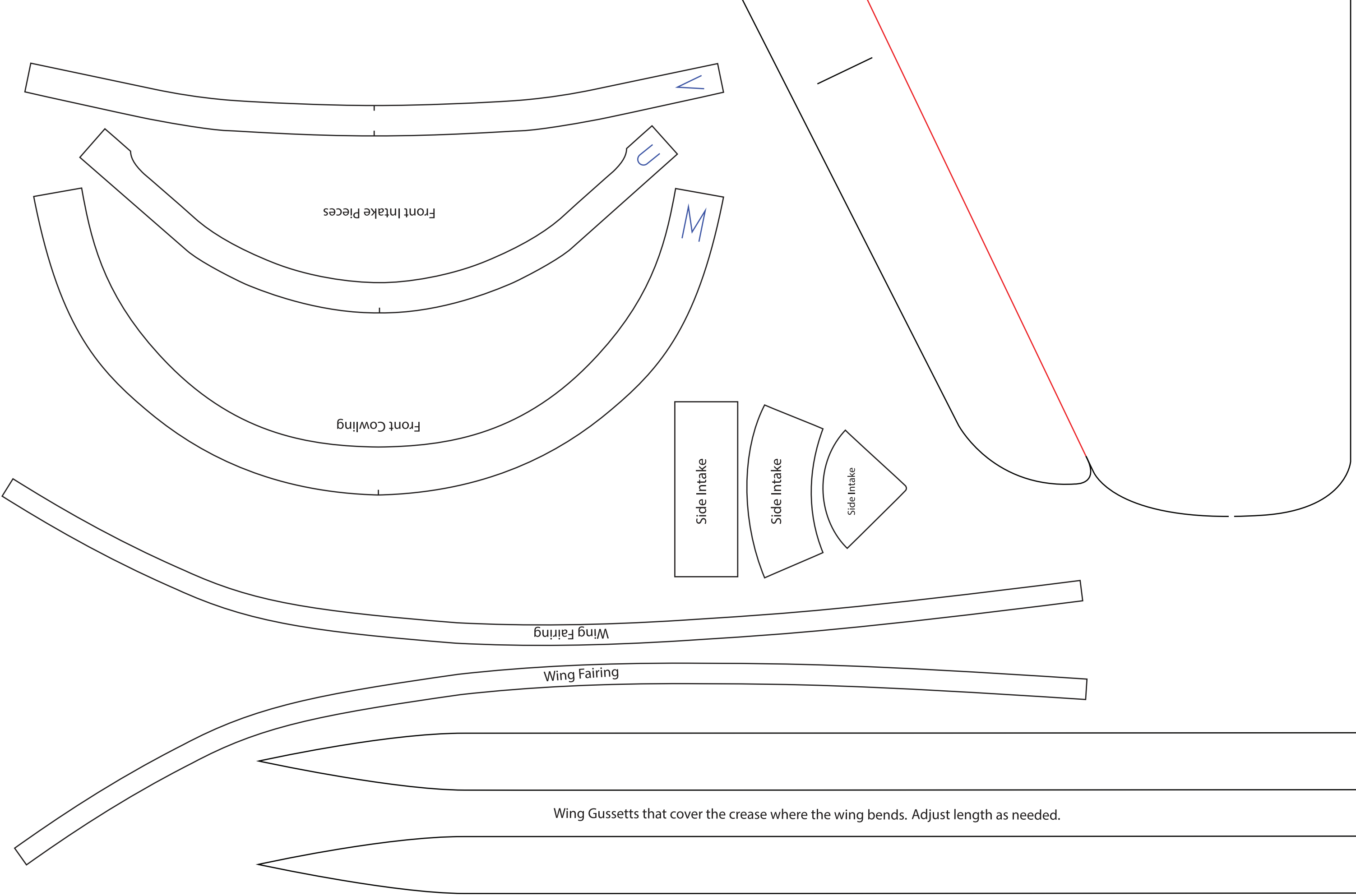

21"

21"

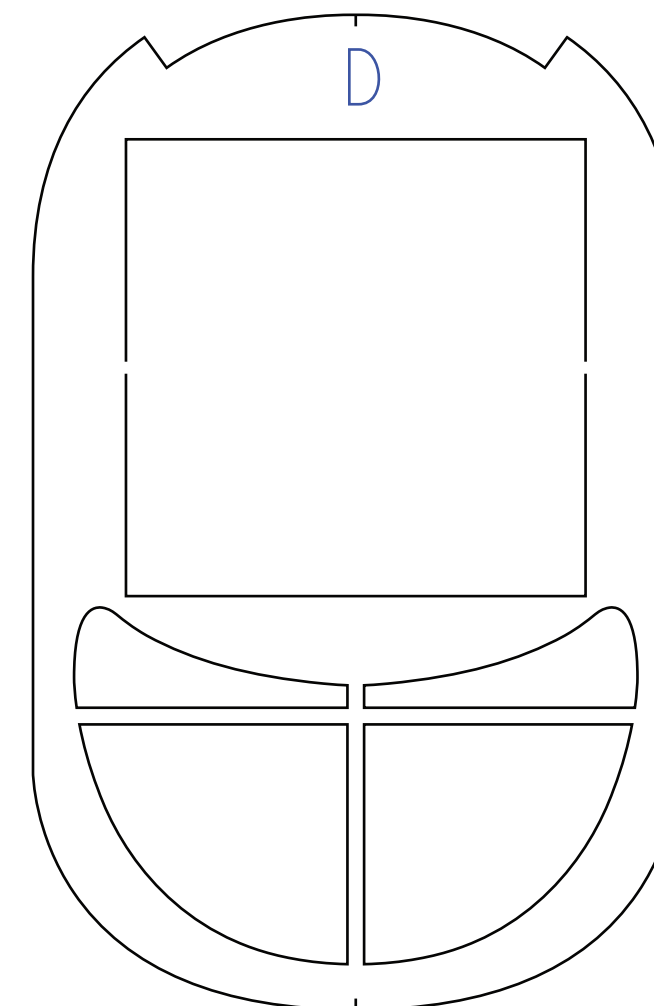
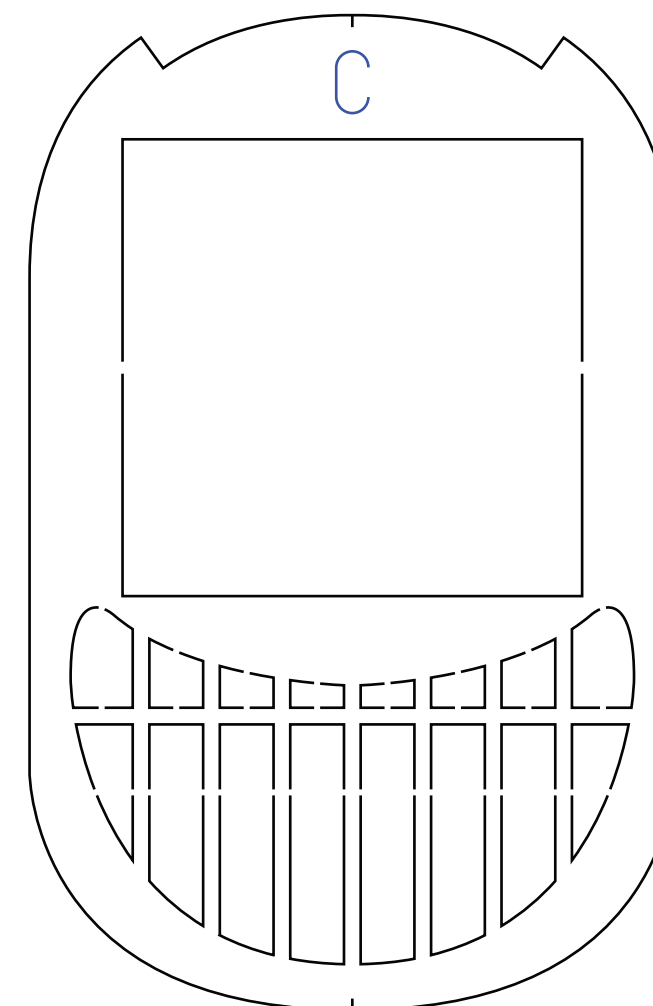
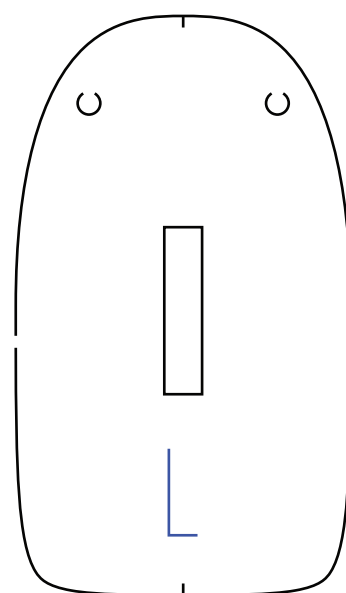
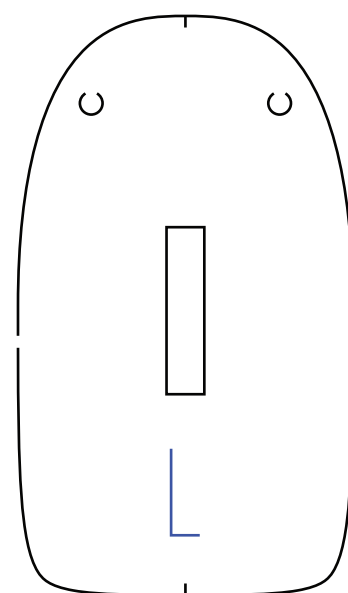
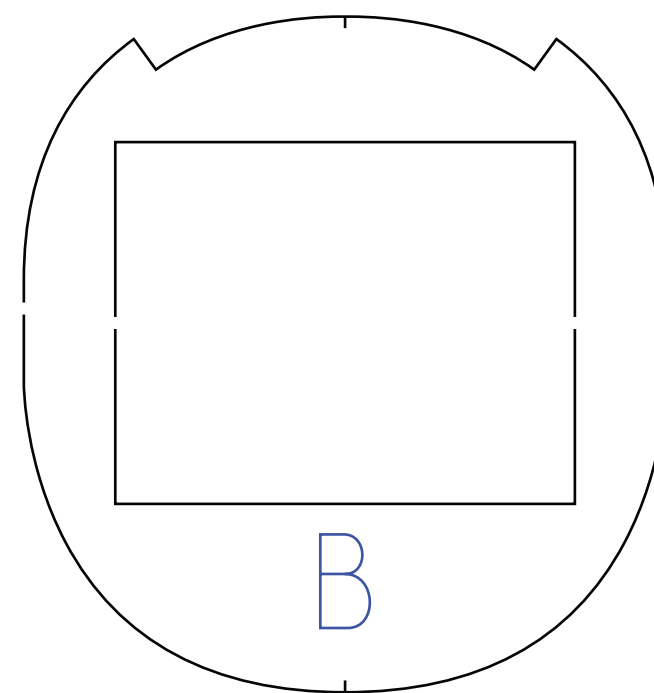
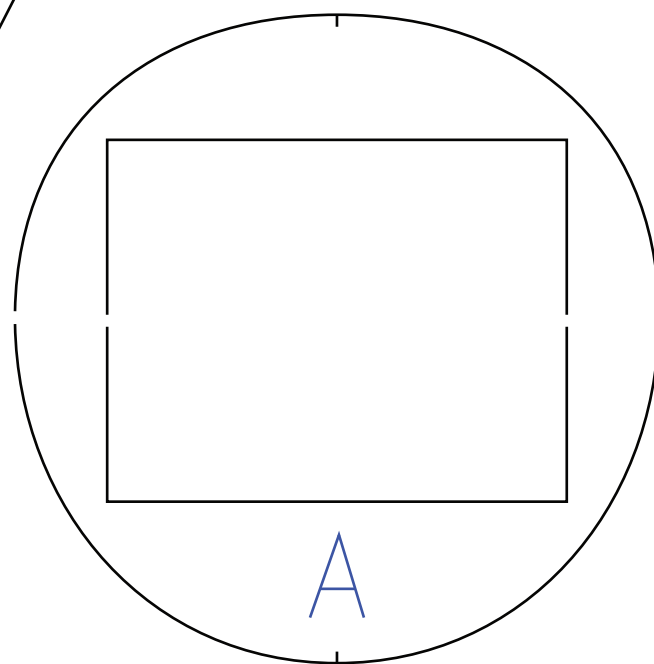

Copyright ©2020 13thSquadron. All Rights Reserved.
Commercial use of our plans are prohibited.

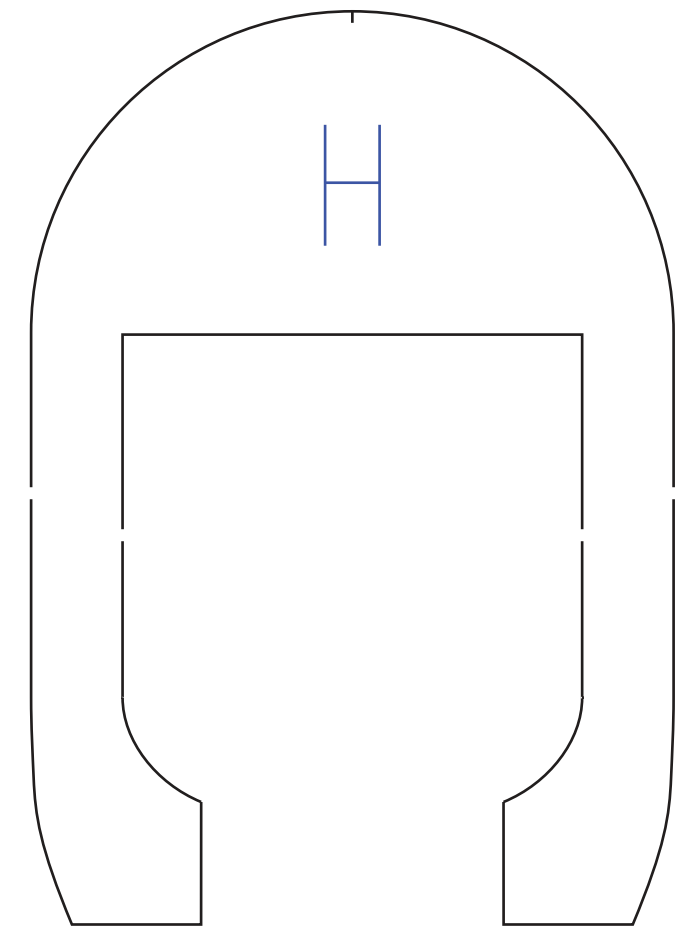
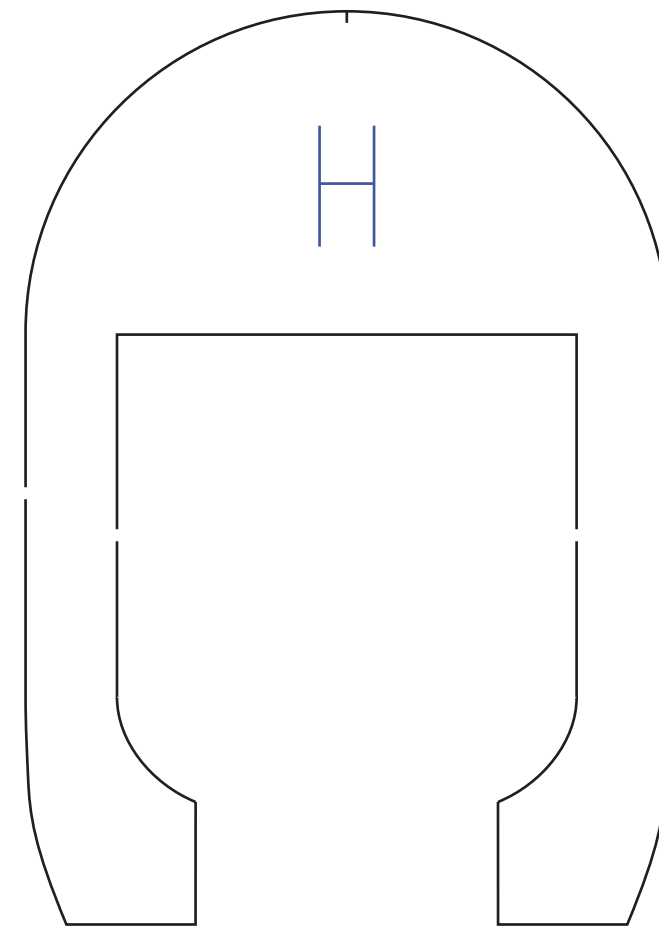
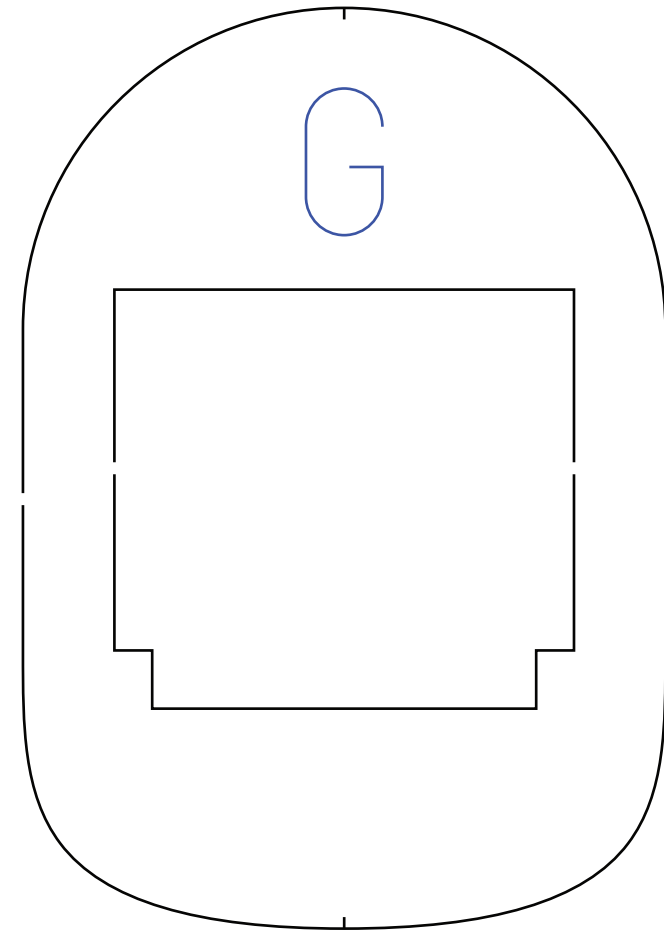
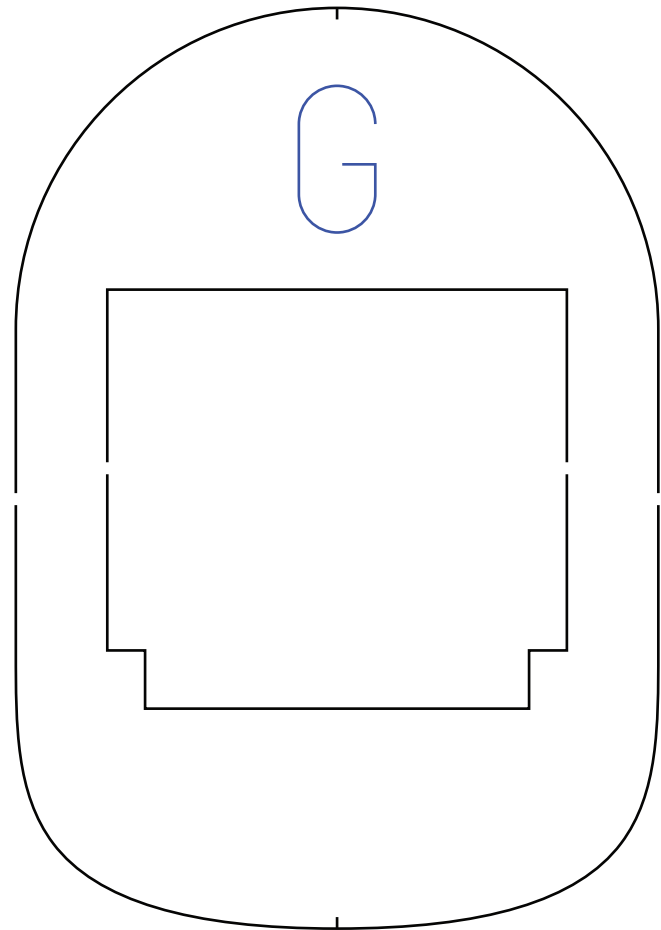
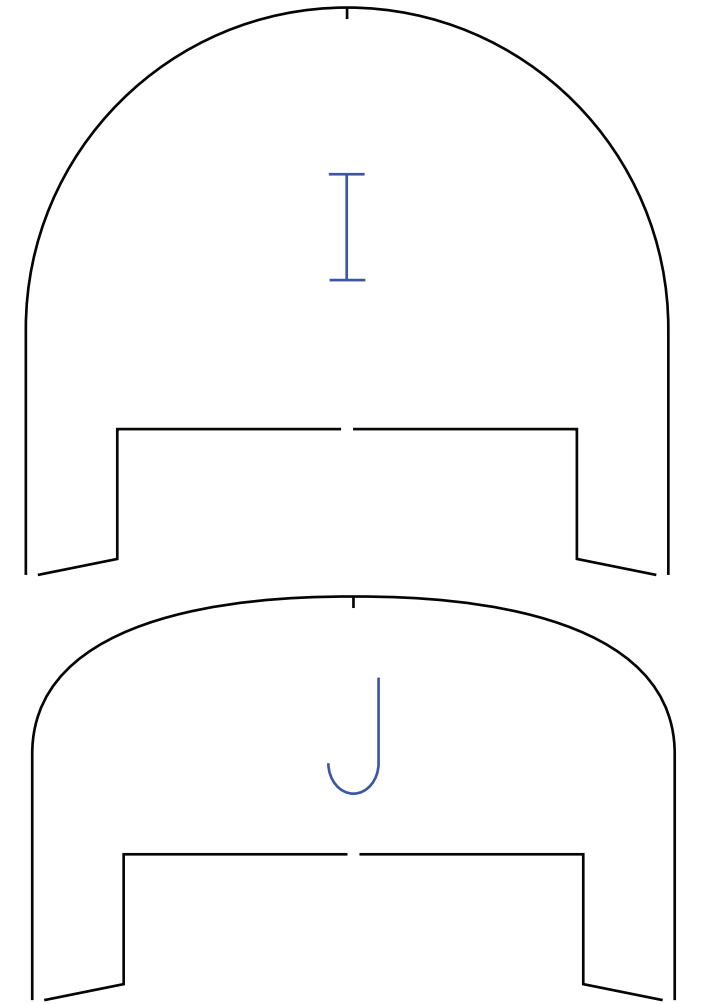
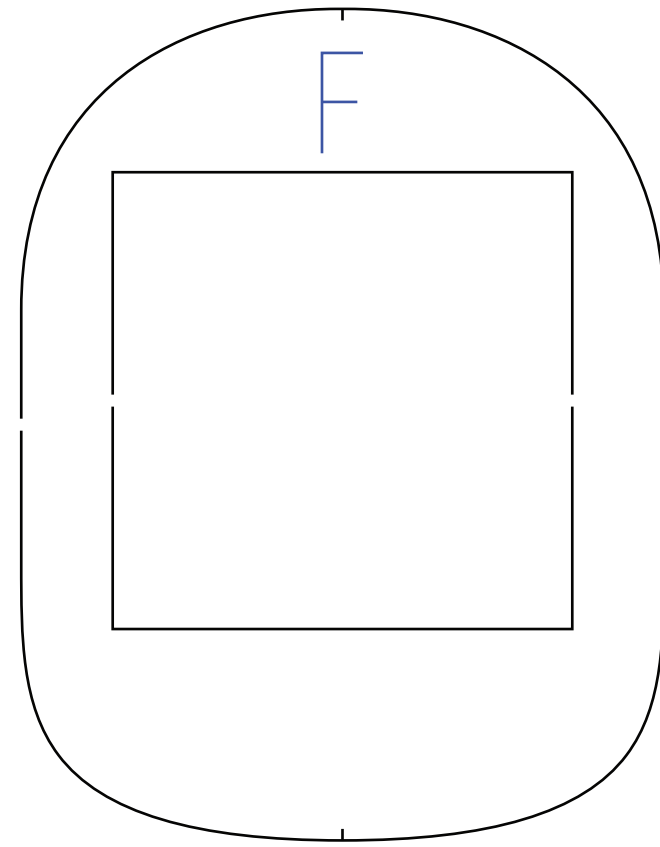
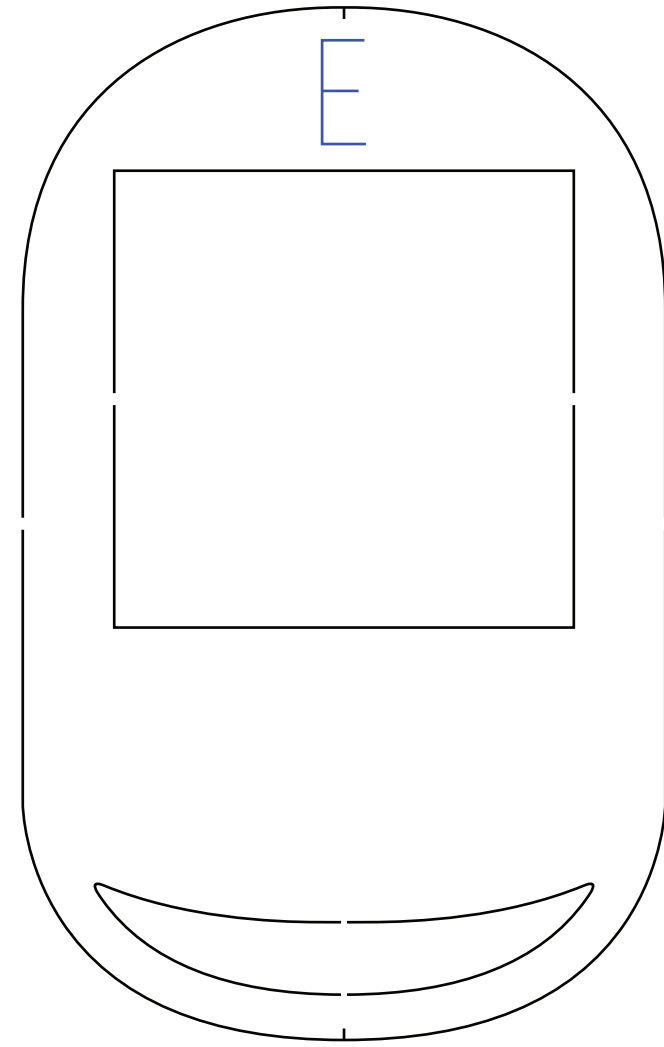
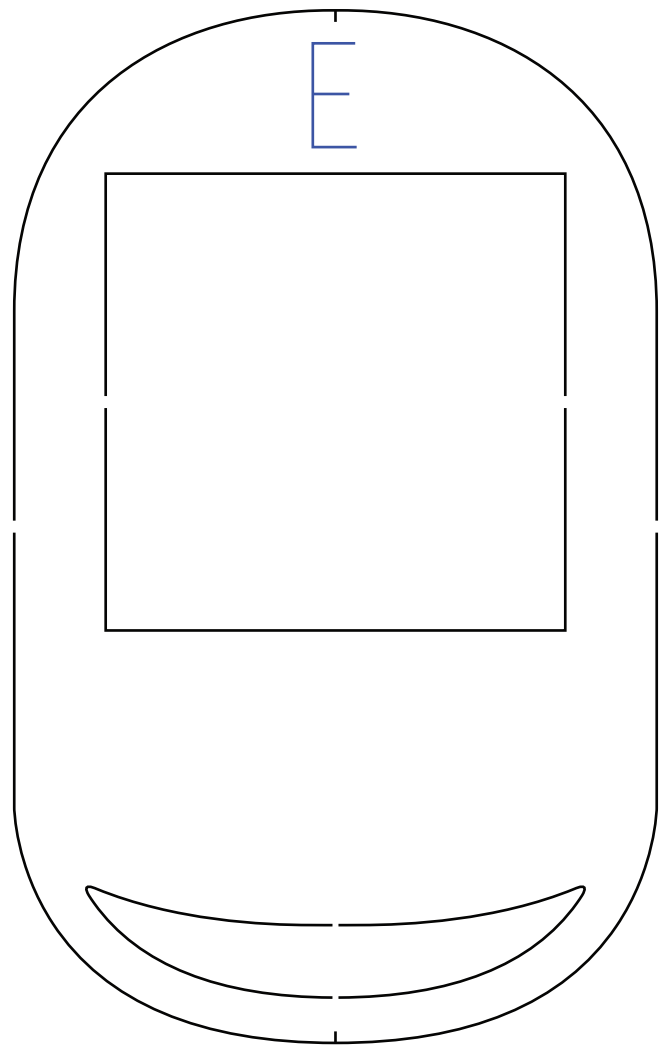

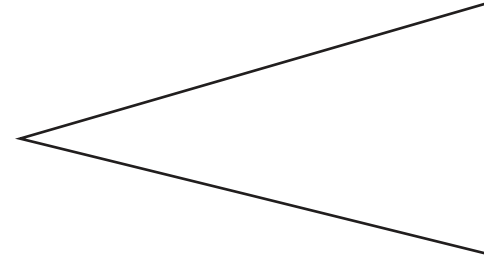
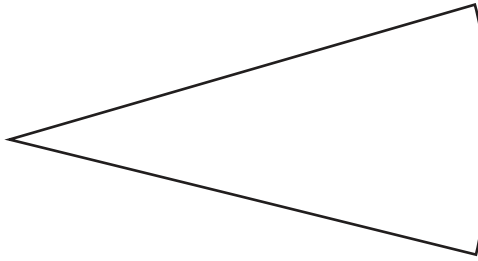
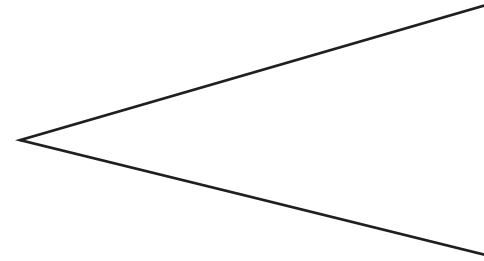
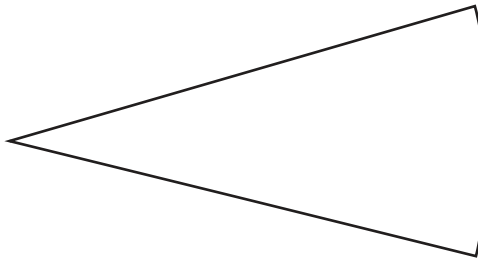
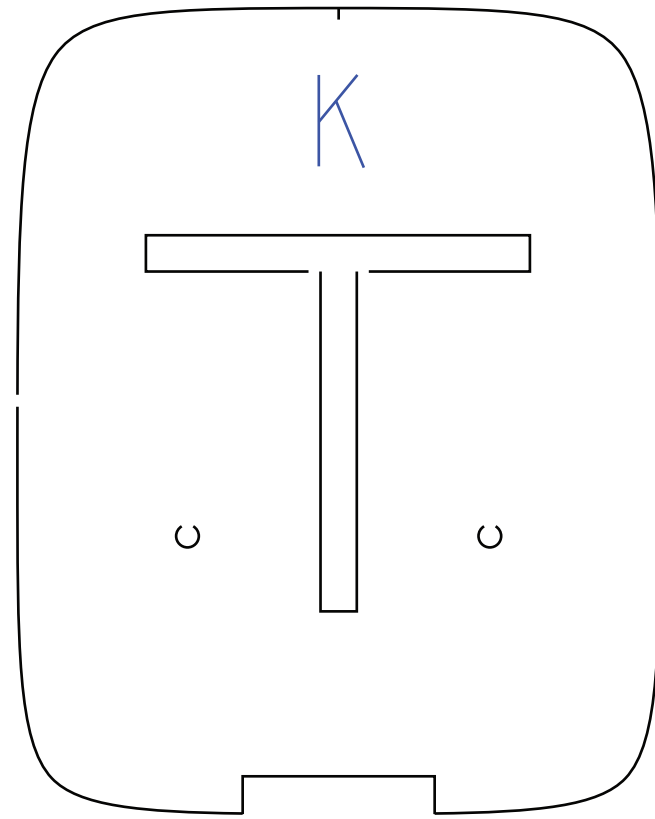
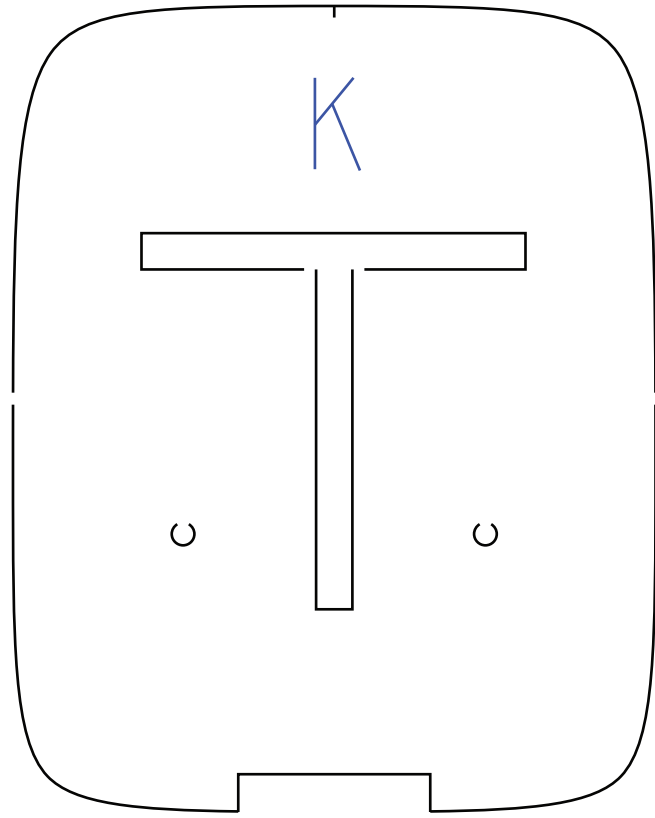

Bomb Parts

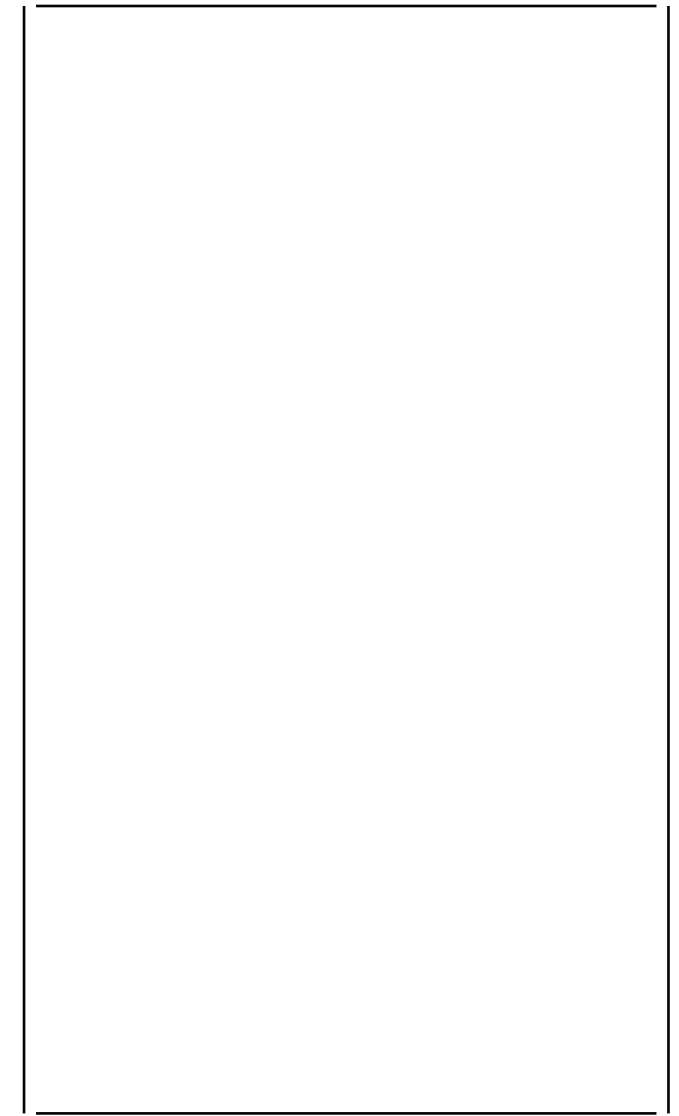
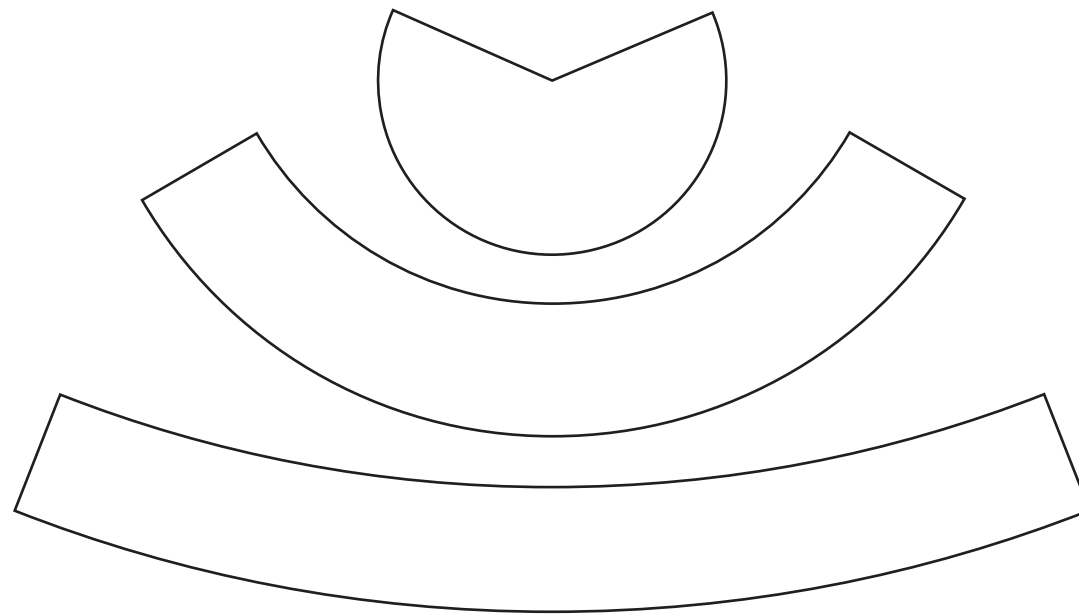
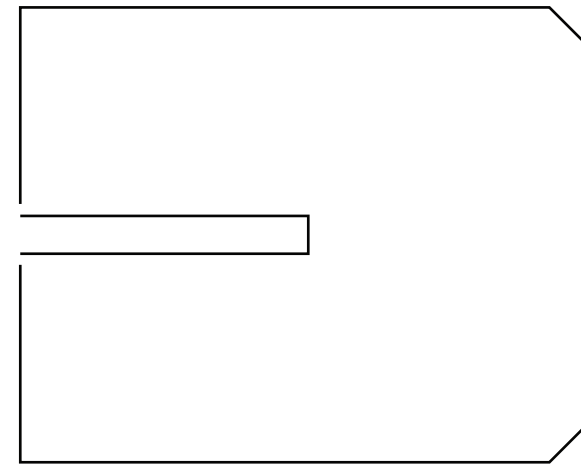
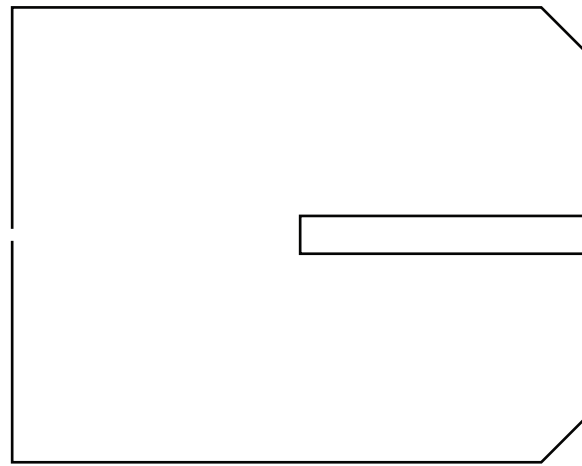
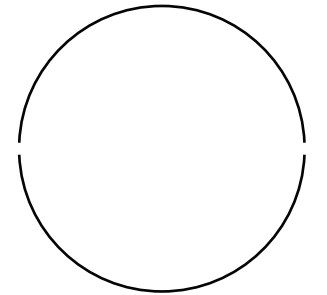
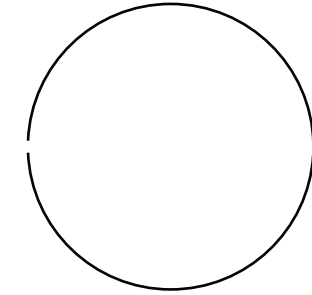

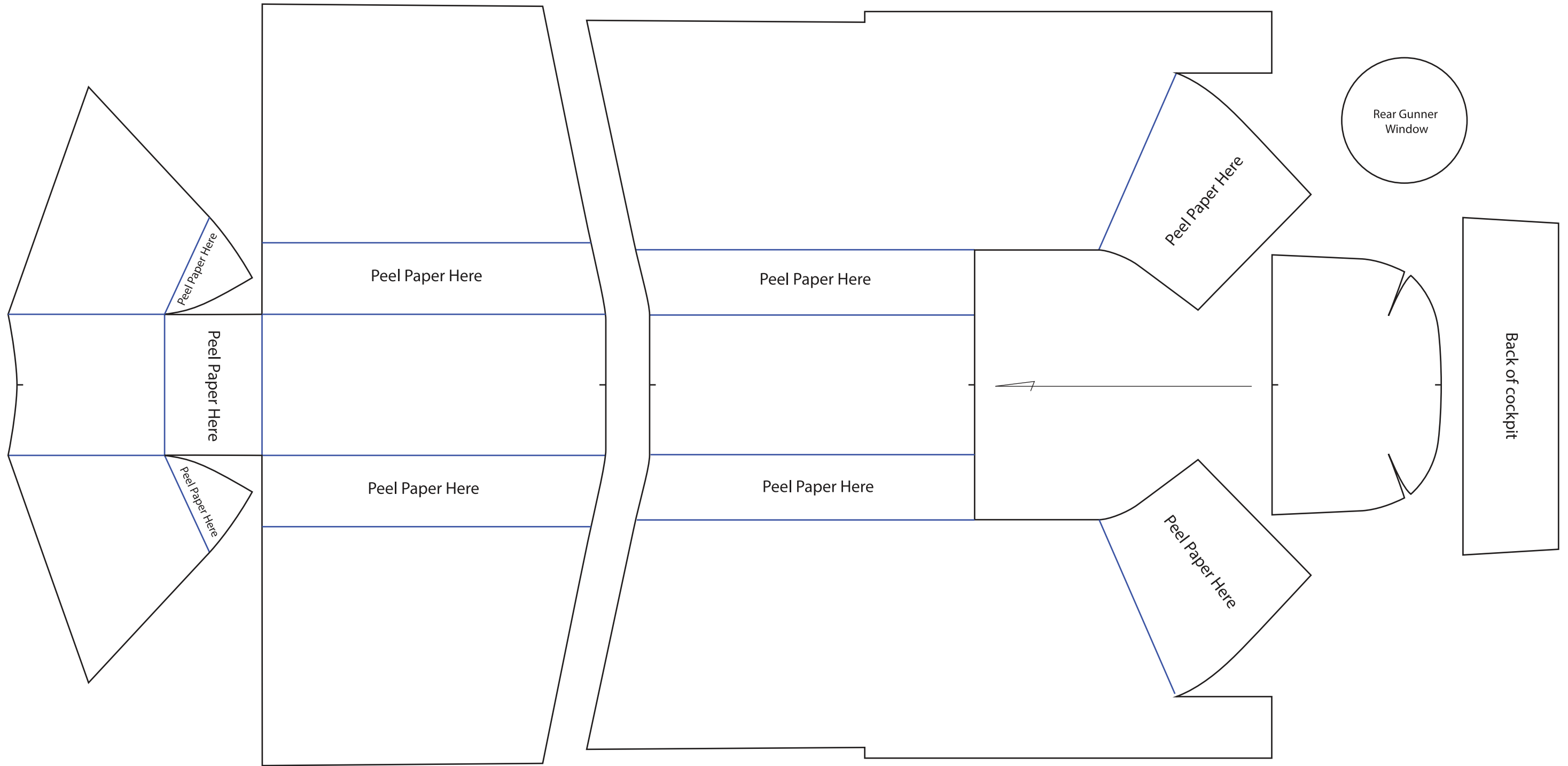

Copyright ©2020 13thSquadron. All Rights Reserved.
Commercial use of our plans are prohibited.

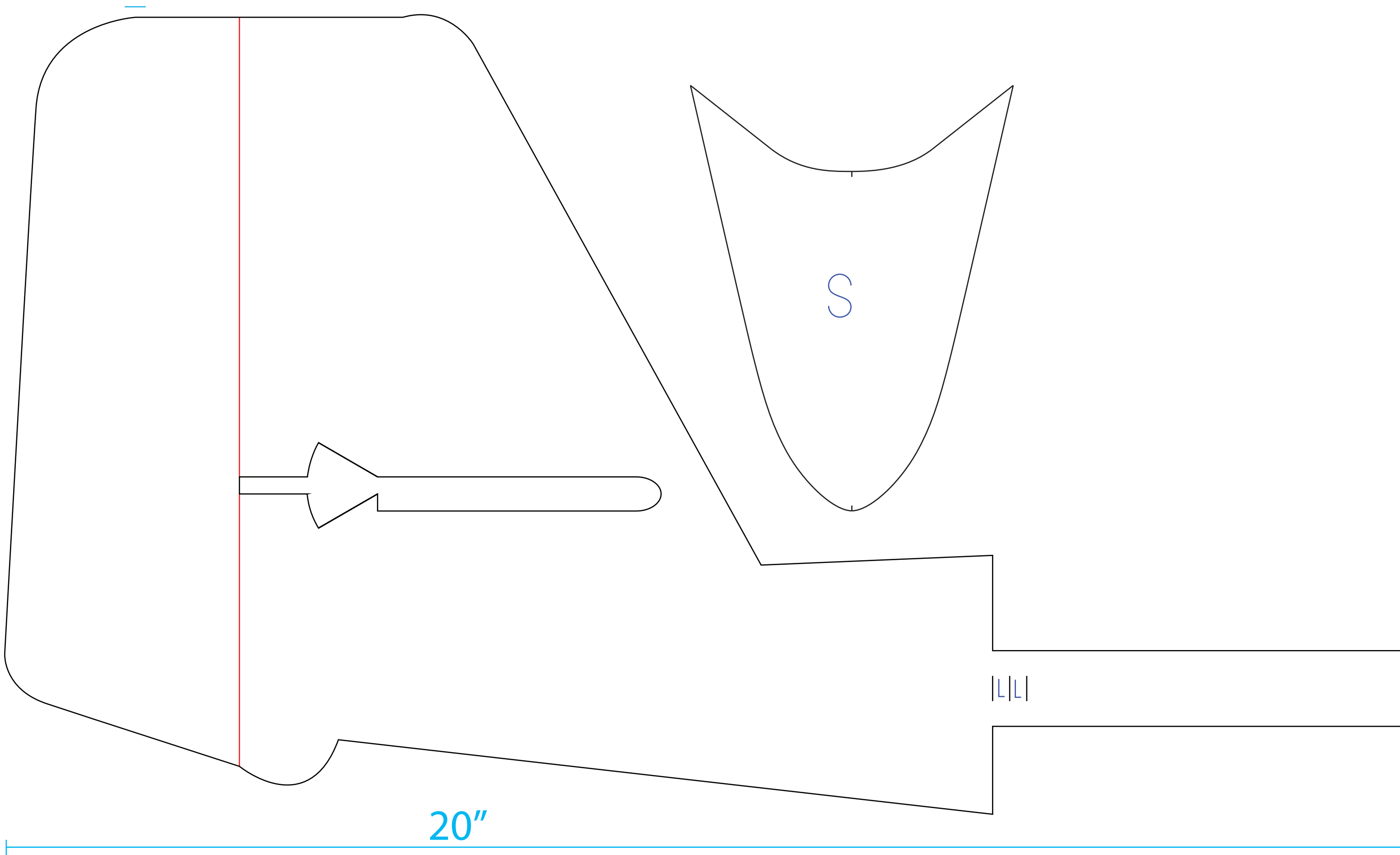

S

L|L

20"

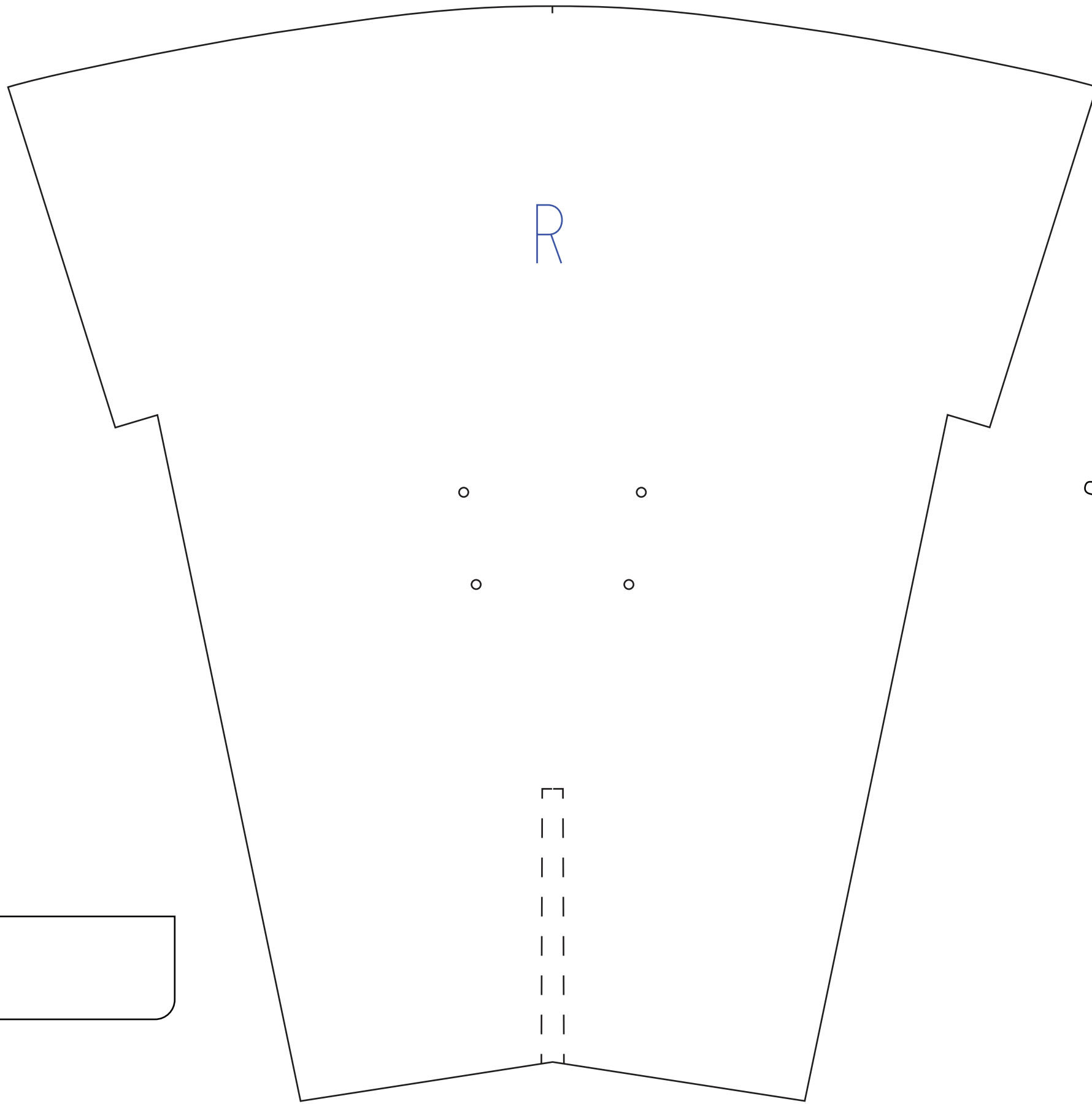

Foamboard and 1/8 inch wood

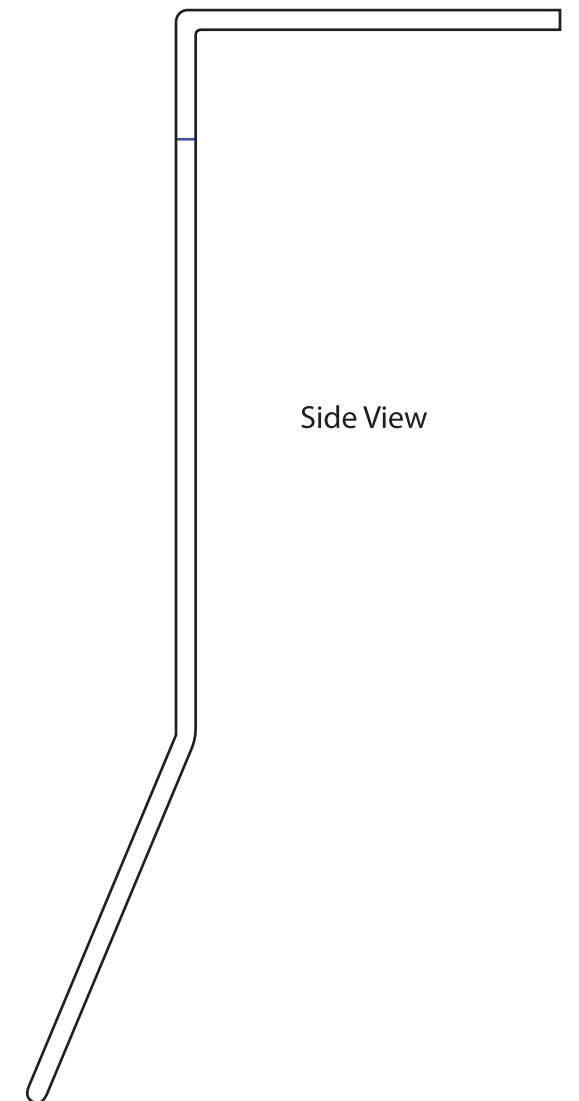
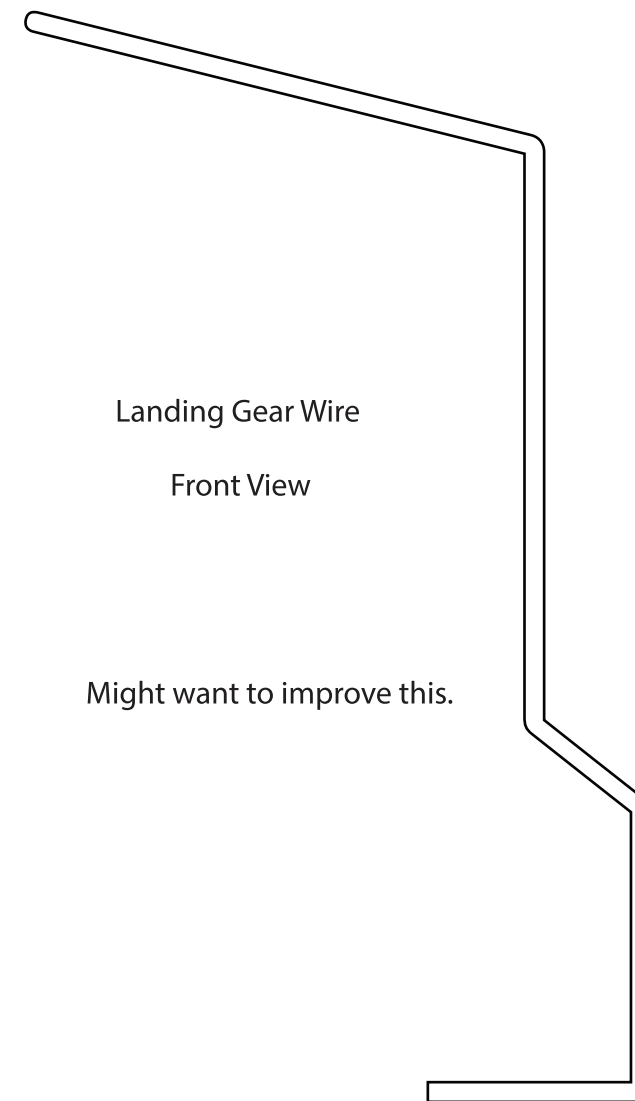
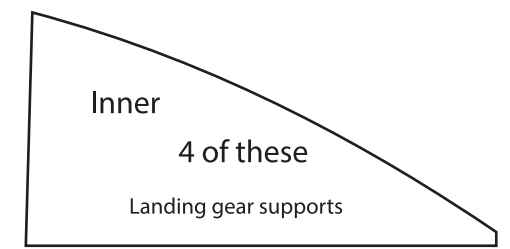
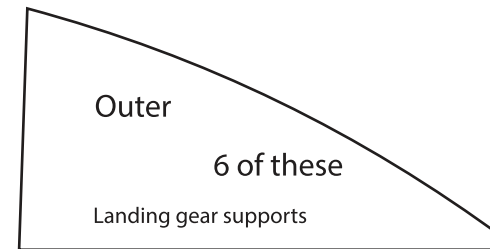
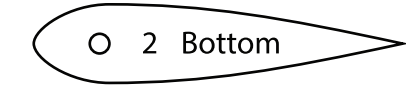

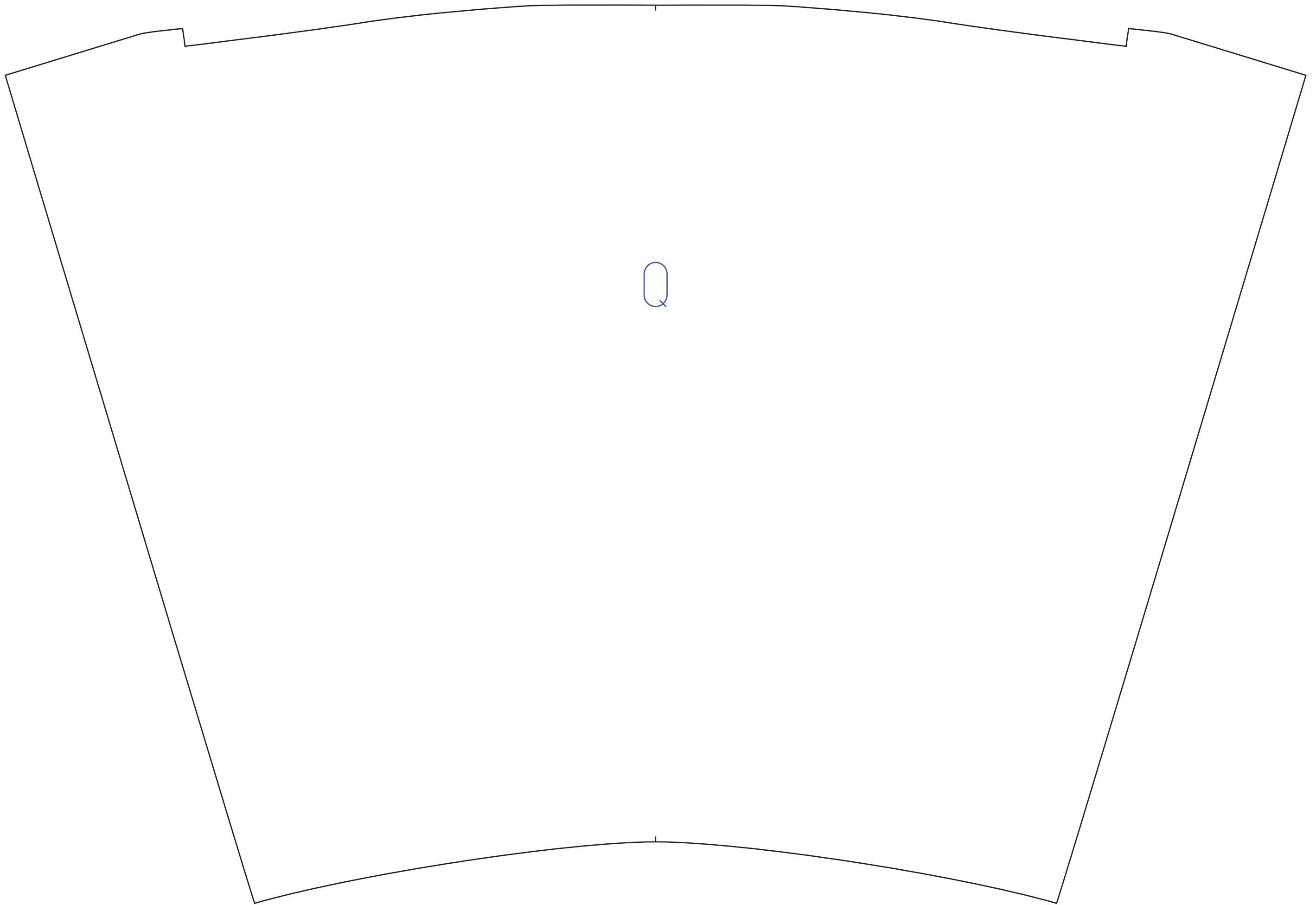

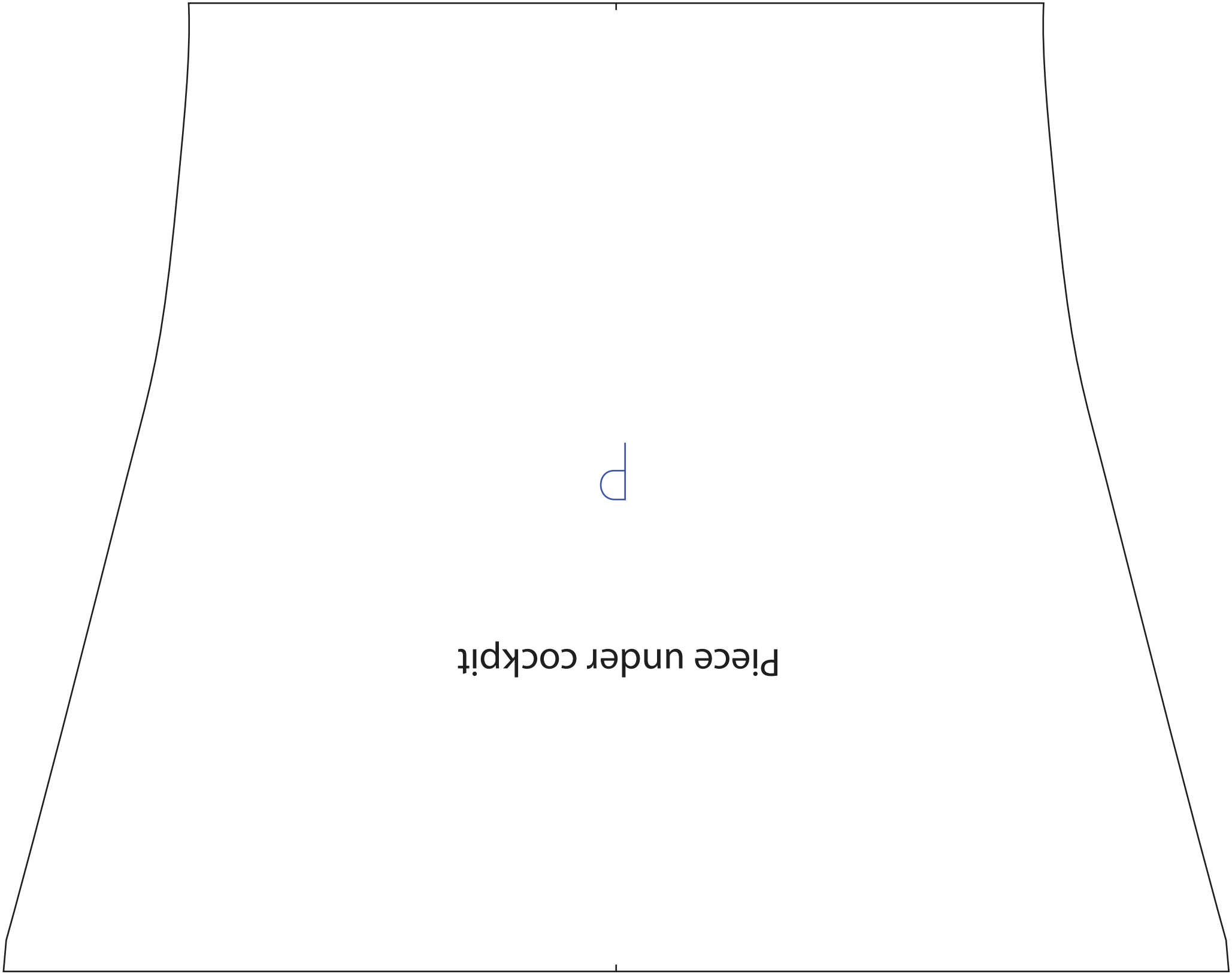

Piece under cockpit

D

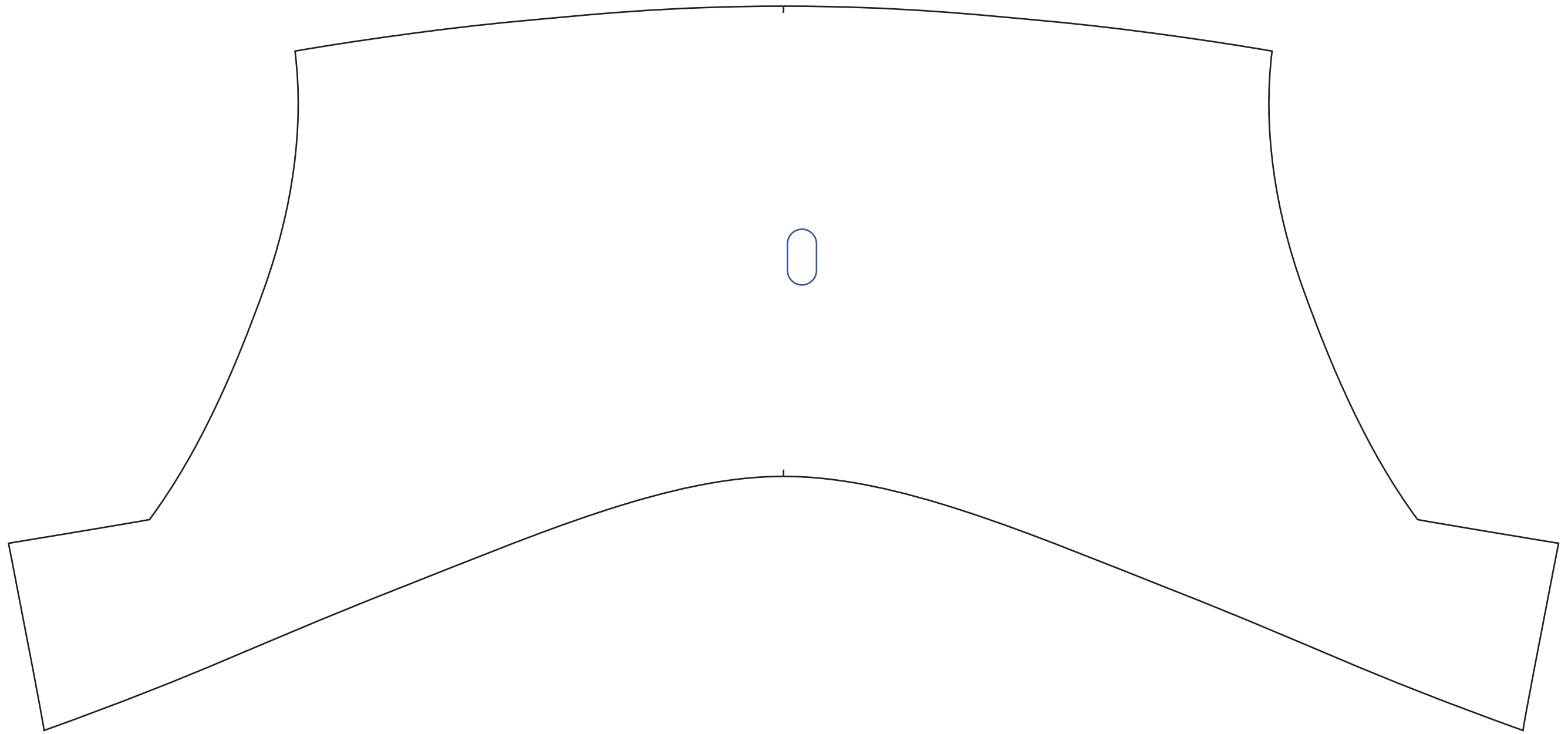

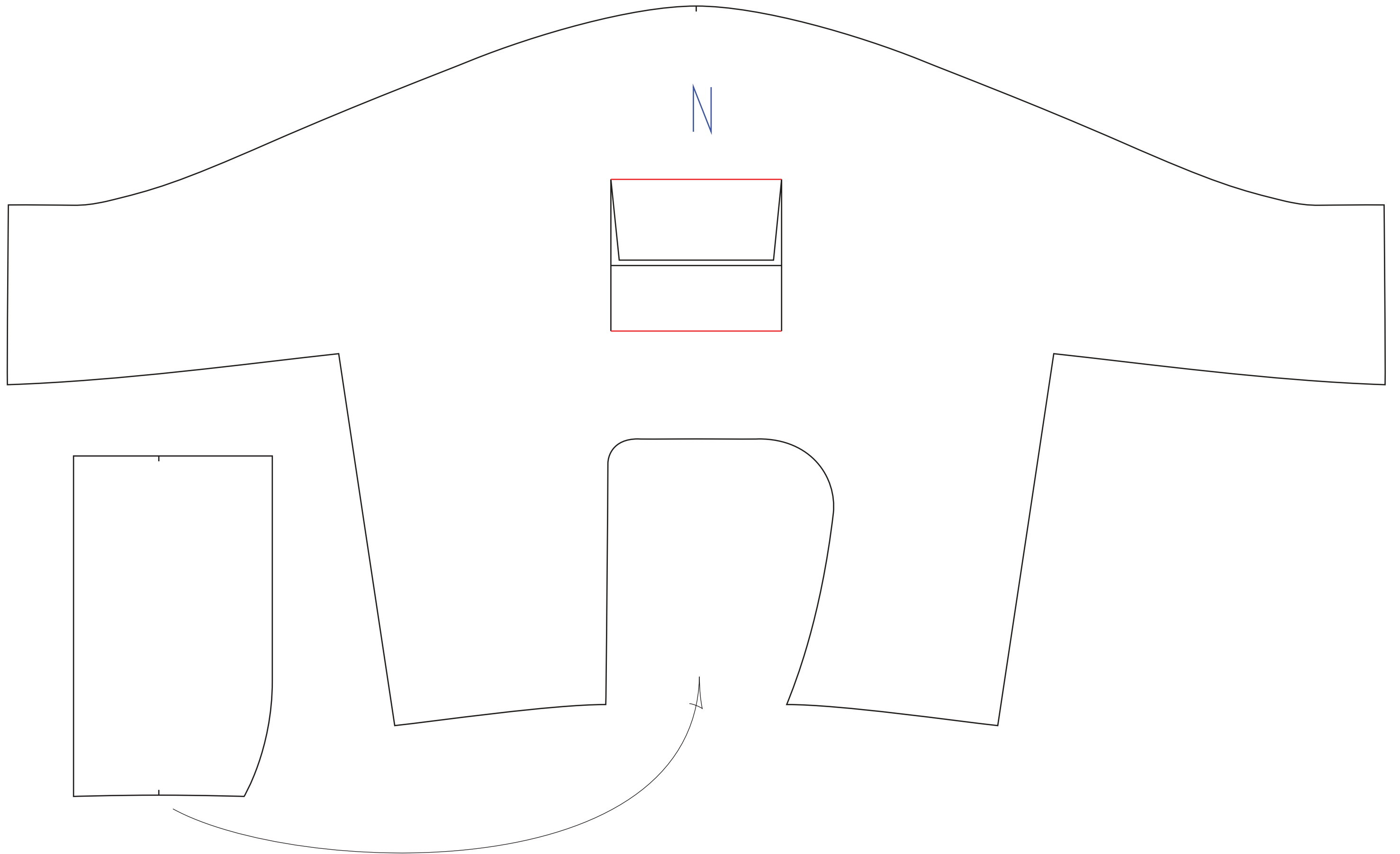

N

This piece goes here

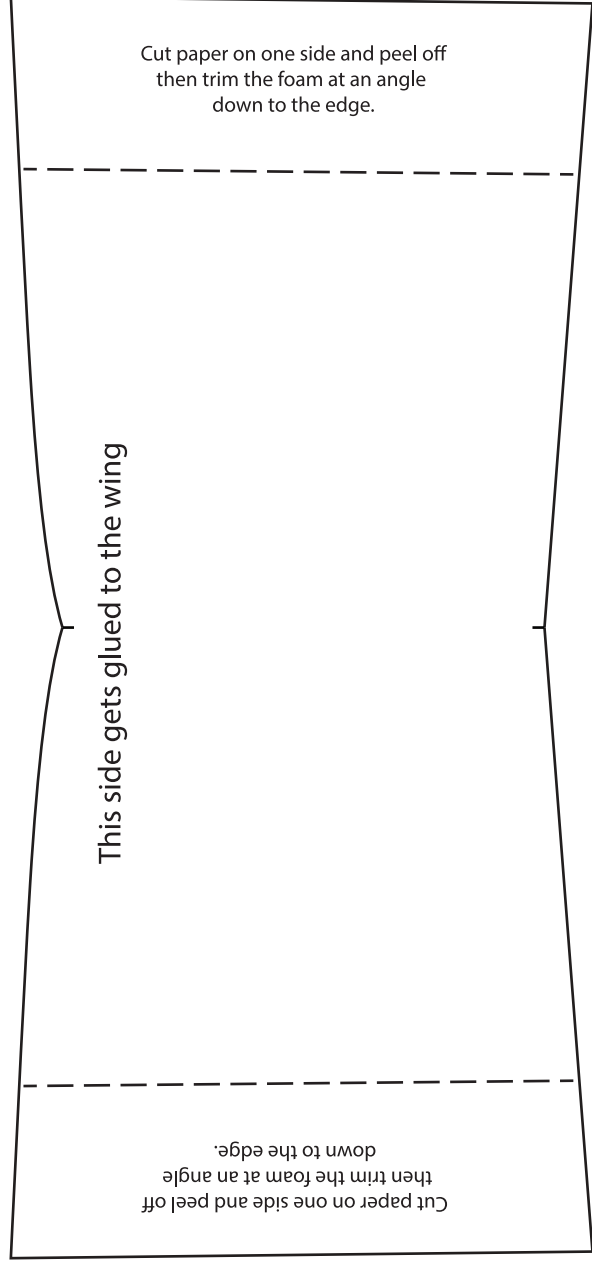

Wheel Pants Pieces

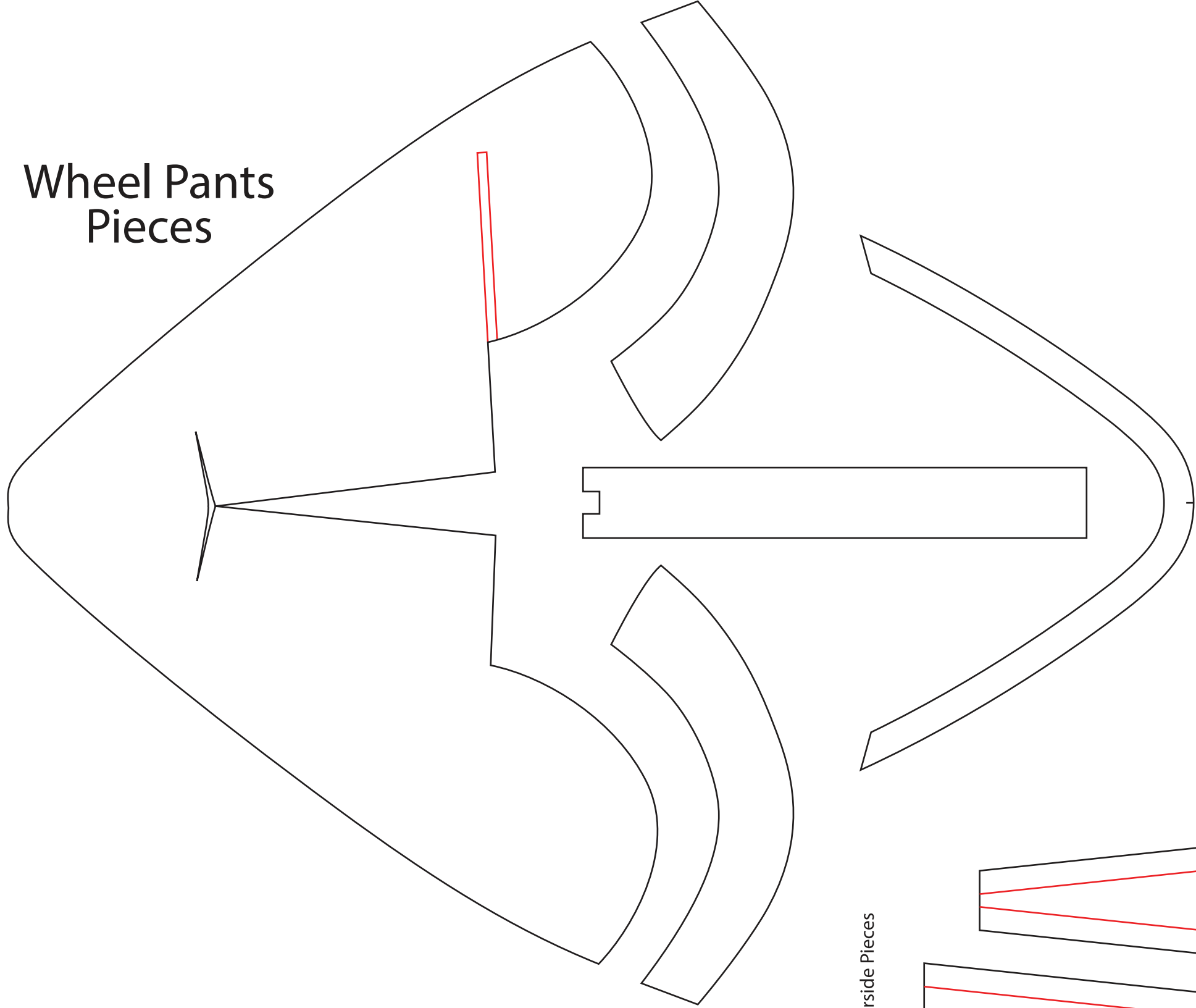

Underside Pieces

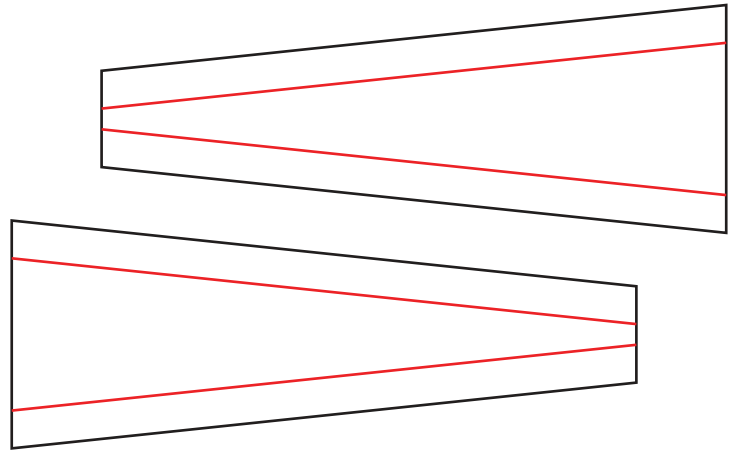

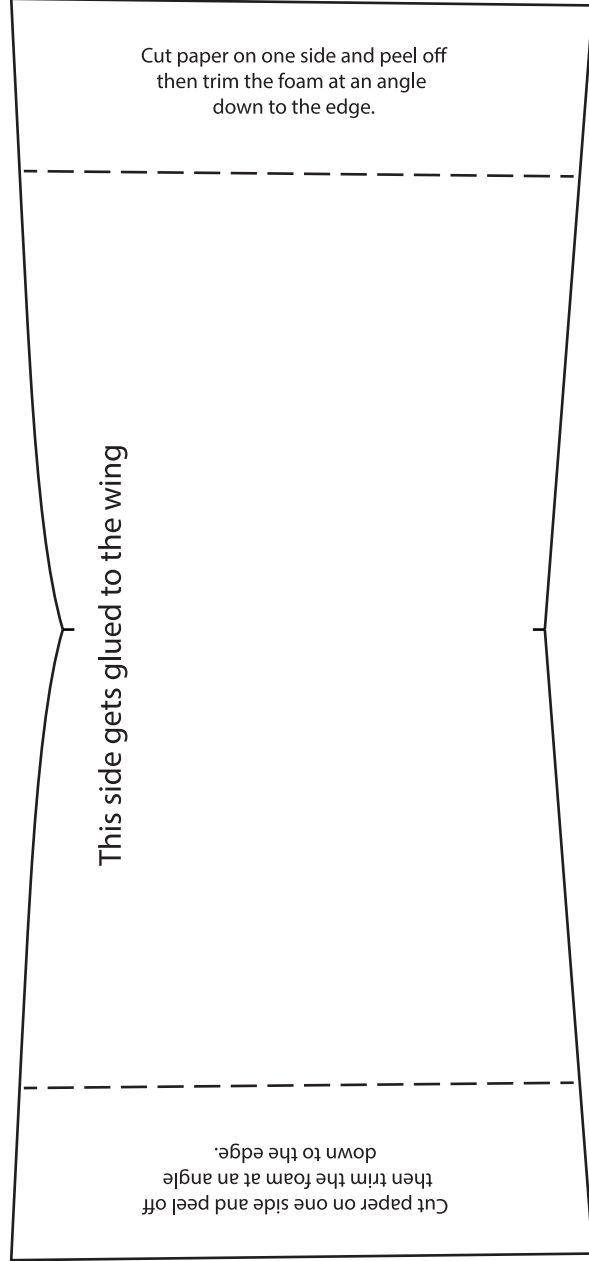

Wheel Pants Pieces

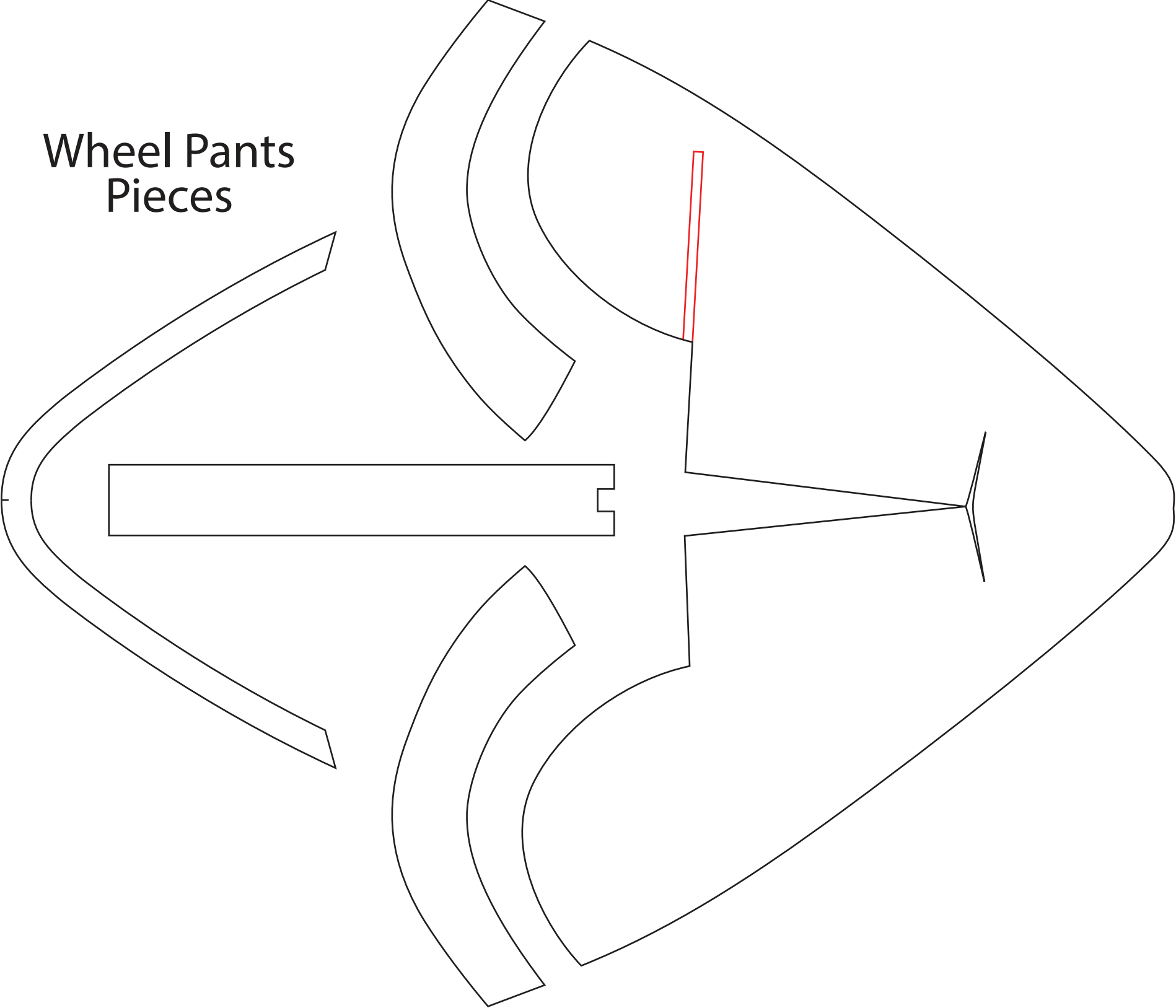

Copyright ©2020 13thSquadron. All Rights Reserved.
Commercial use of our plans are prohibited.

