

If you'd like to make your plane swappable, then follow the directions below. If you don't care to make it have swappable engines, then just glue all of the pieces together.

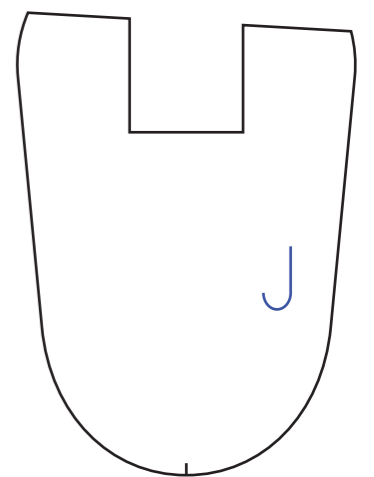

Do not glue the "I" formers to the engine mount if you are making it swappable.

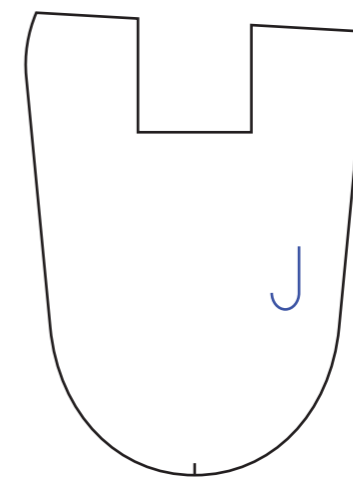
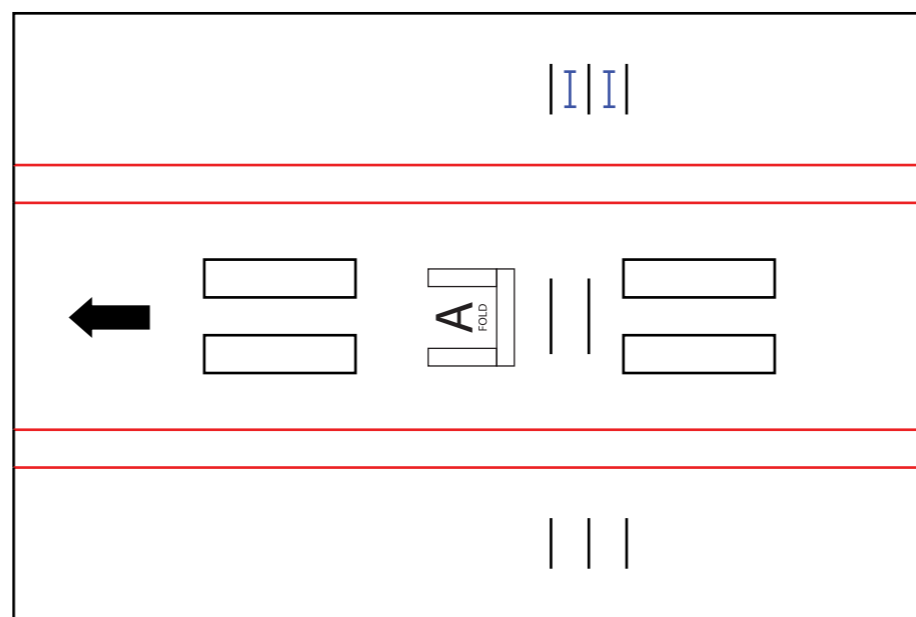
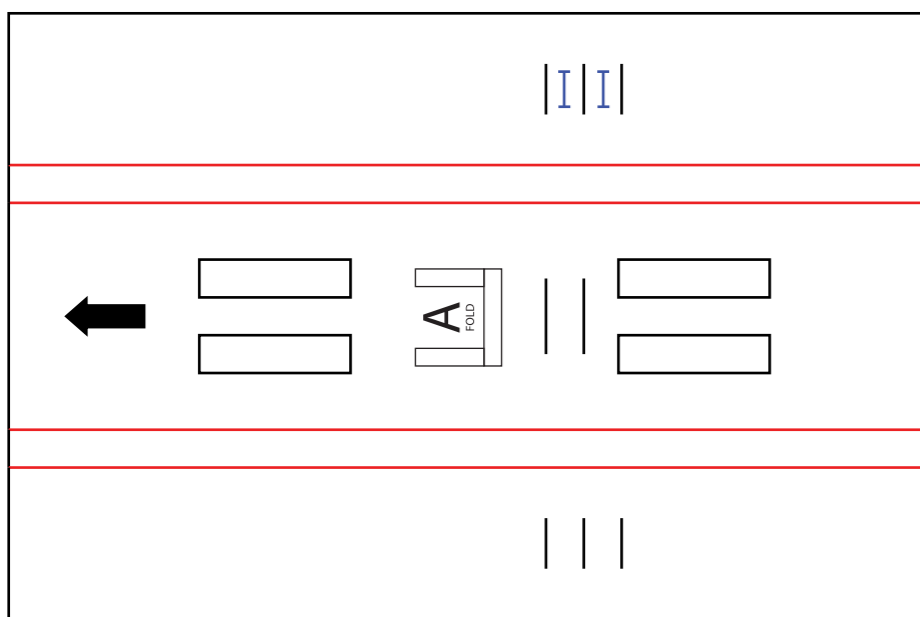
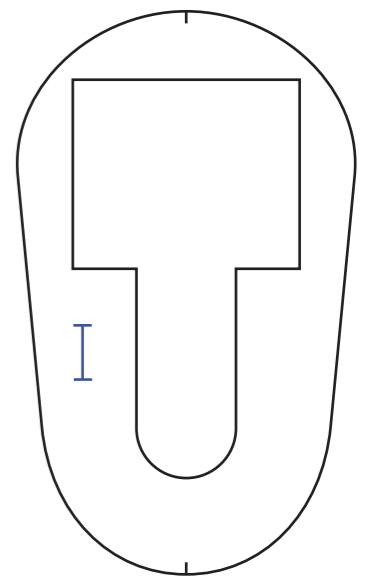
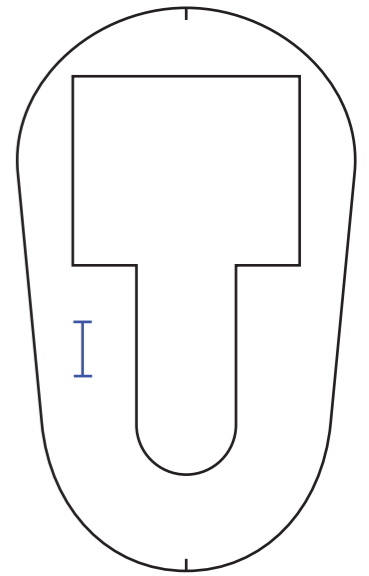
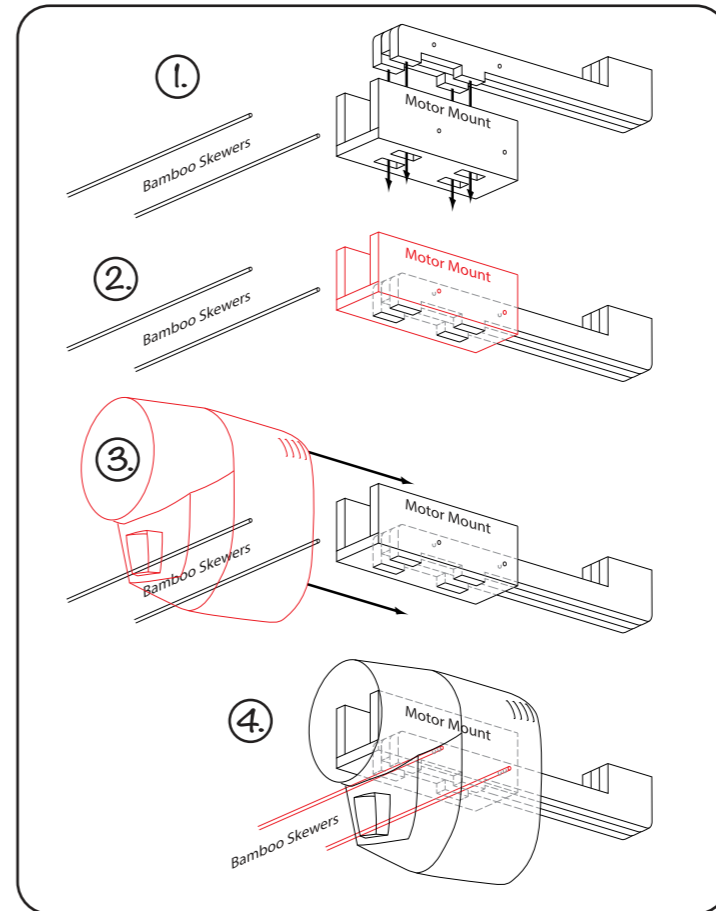
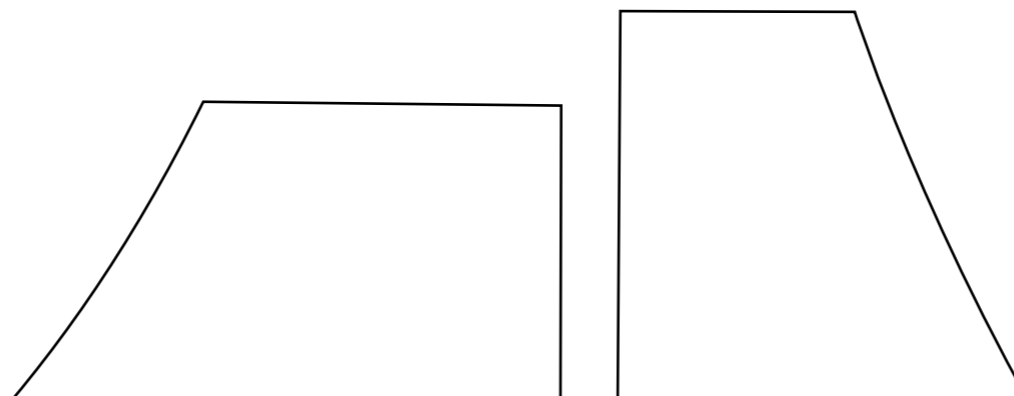
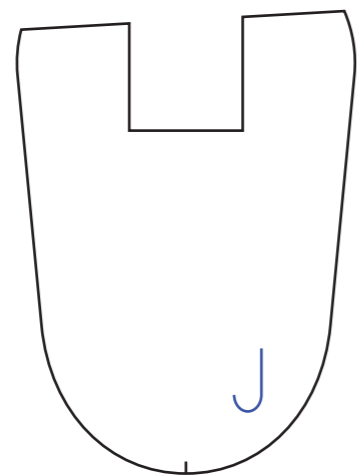
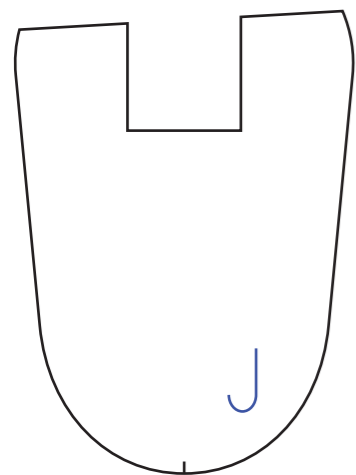
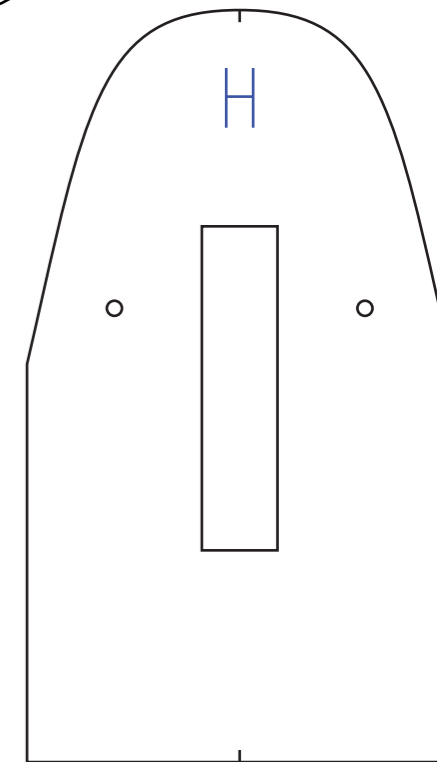
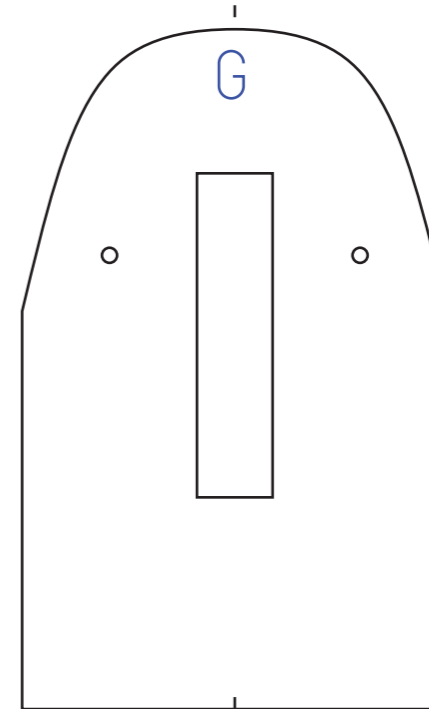
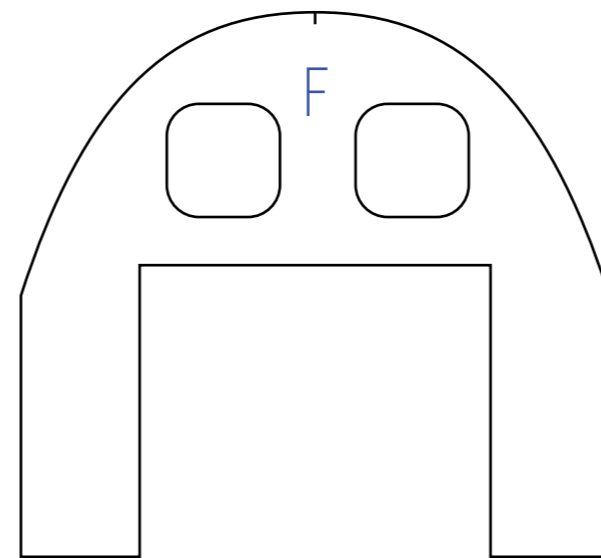
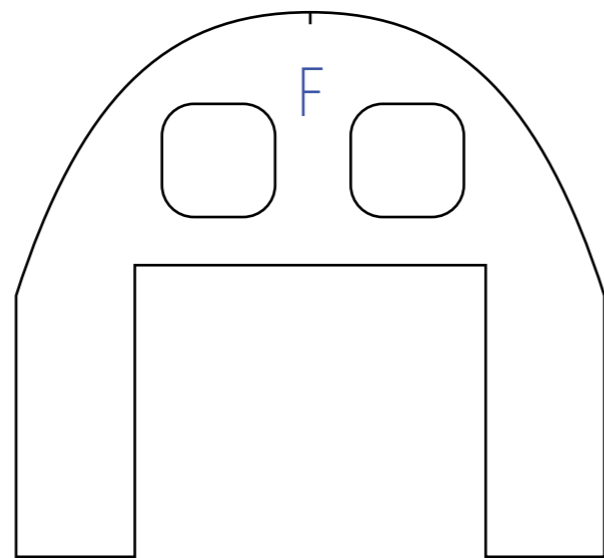
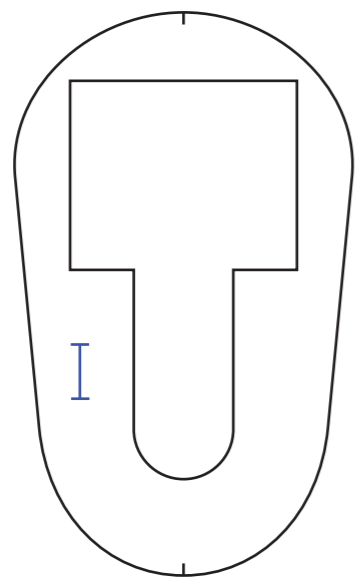
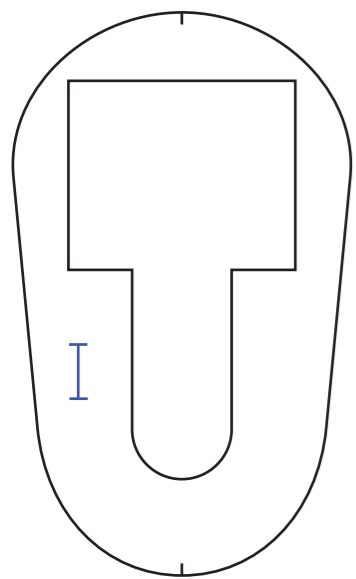
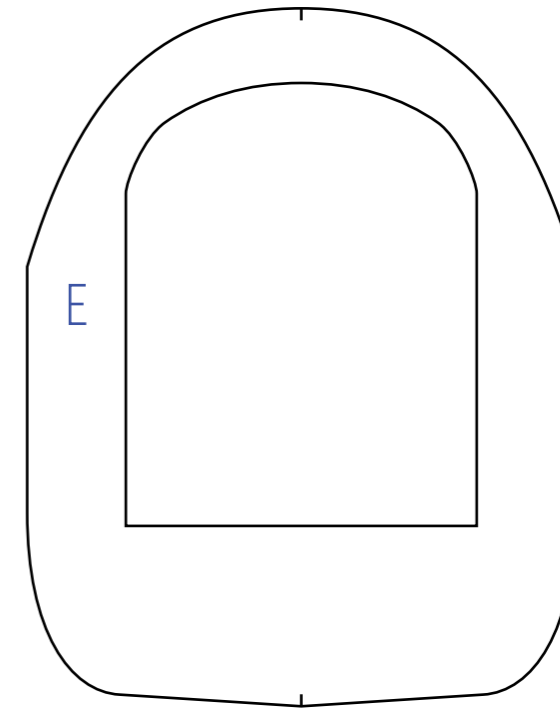
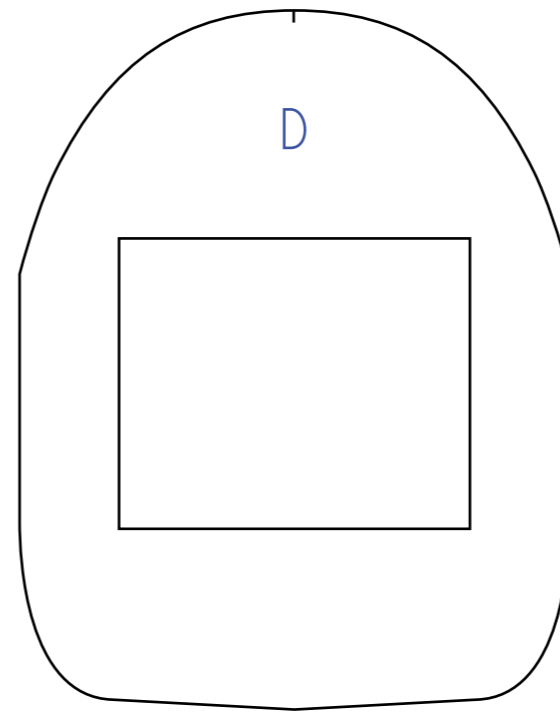
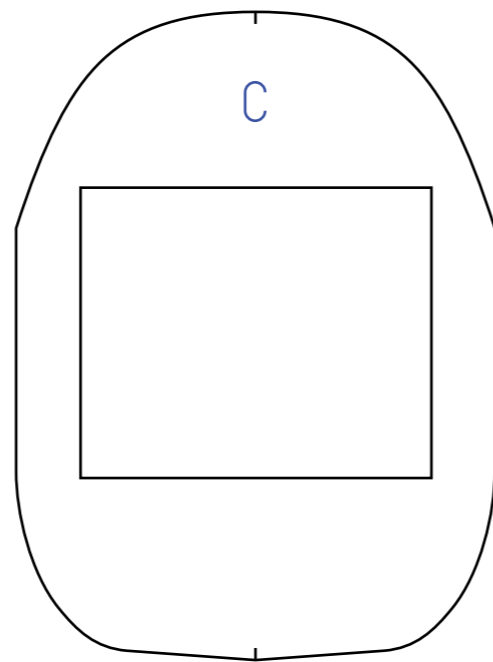
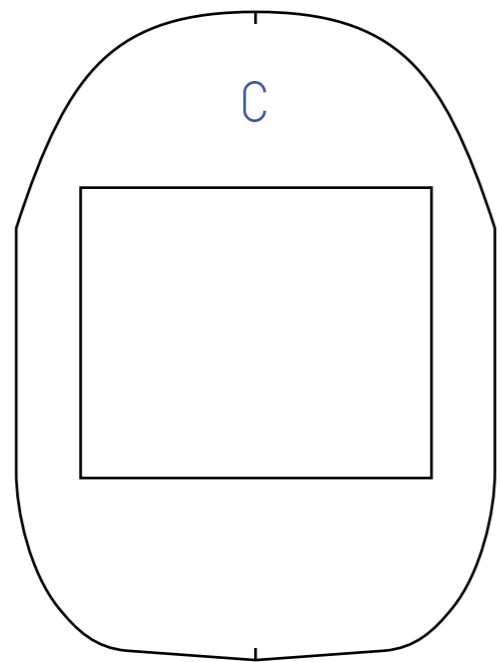
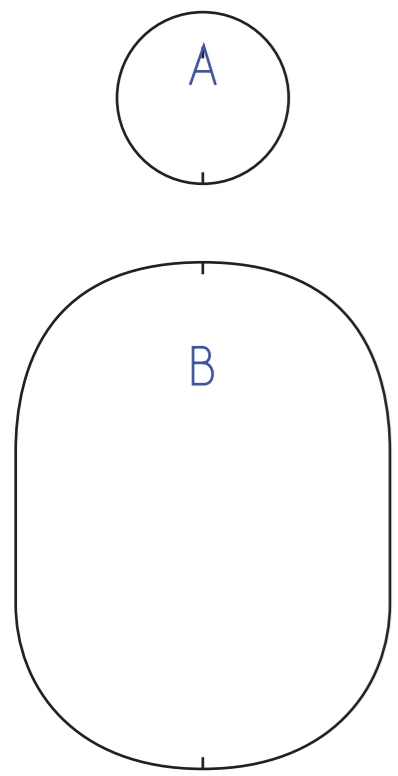

Copyright ©2021 13thSquadron. All Rights Reserved.
Commercial use of our plans are prohibited.

Copyright ©2021 13thSquadron. All Rights Reserved.
Commercial use of our plans are prohibited.

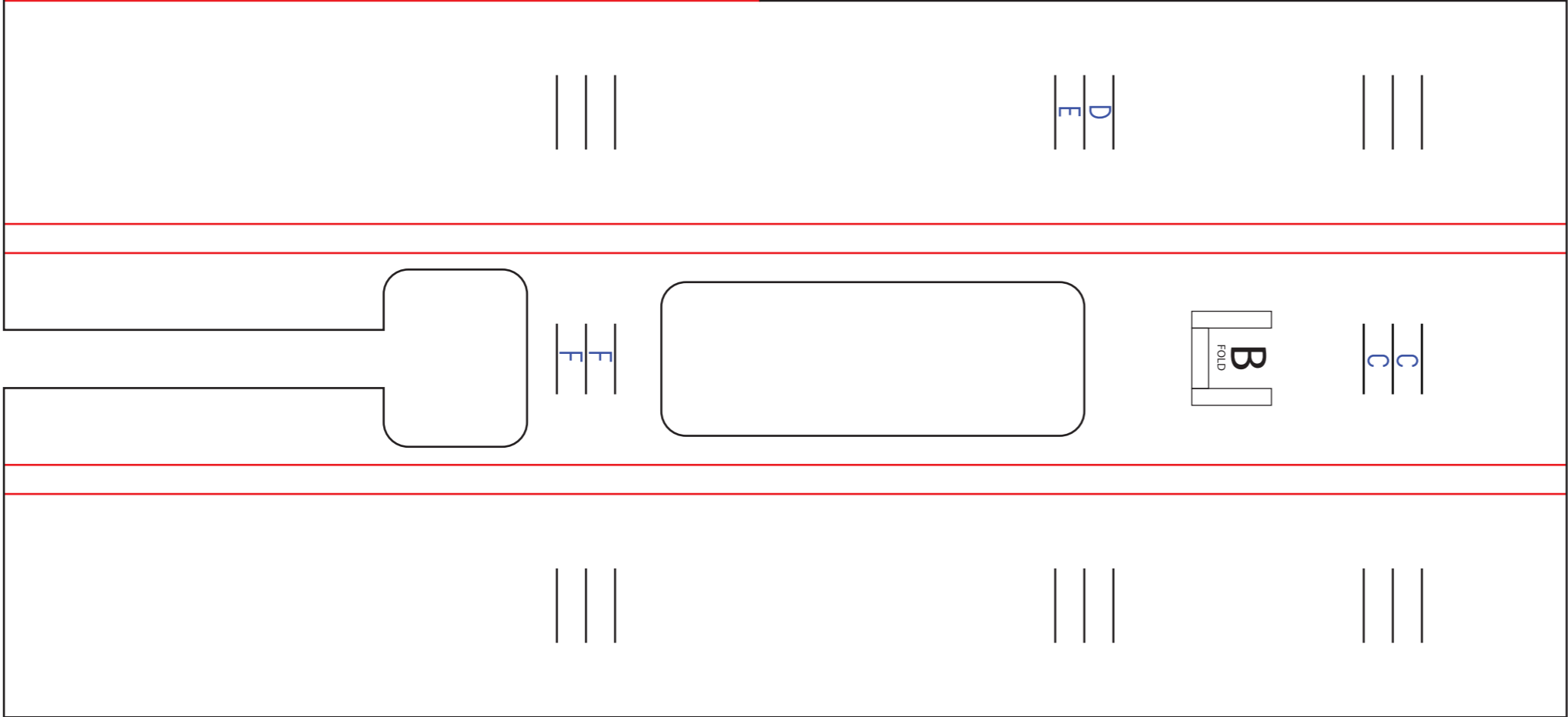
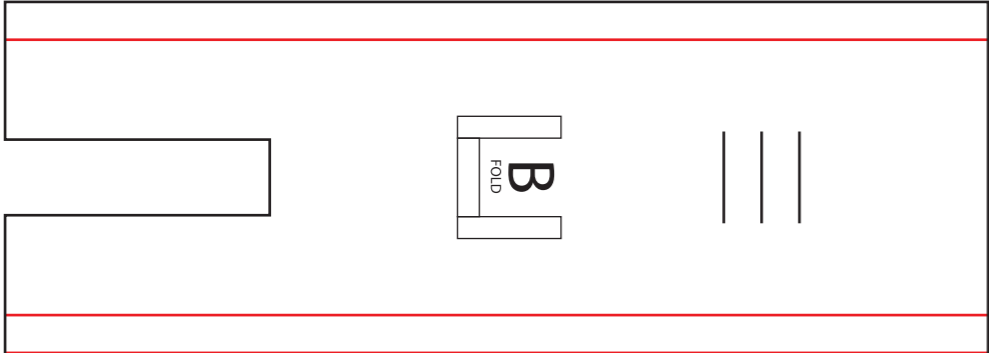
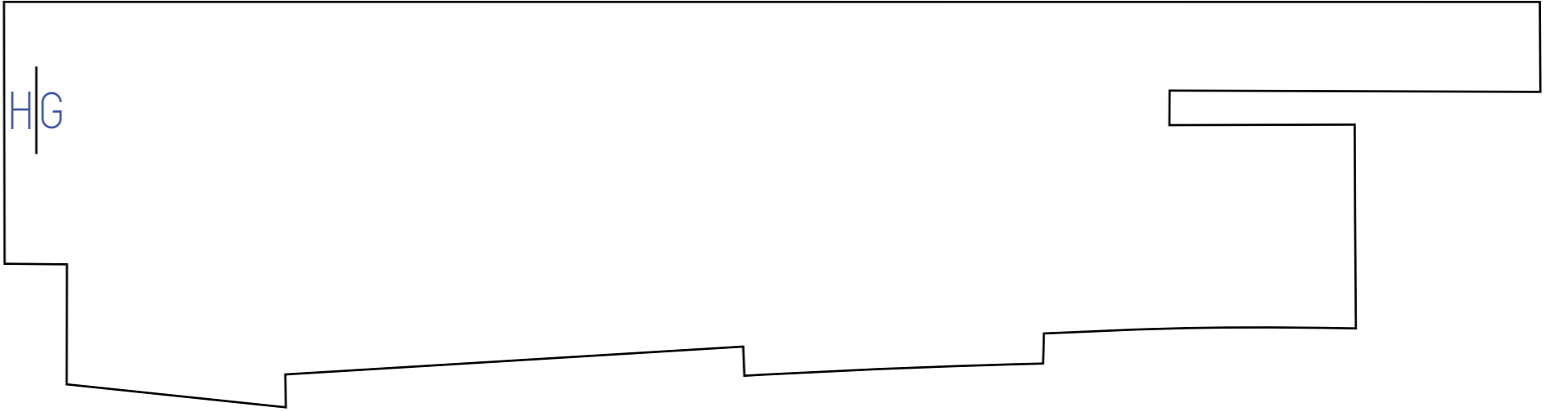
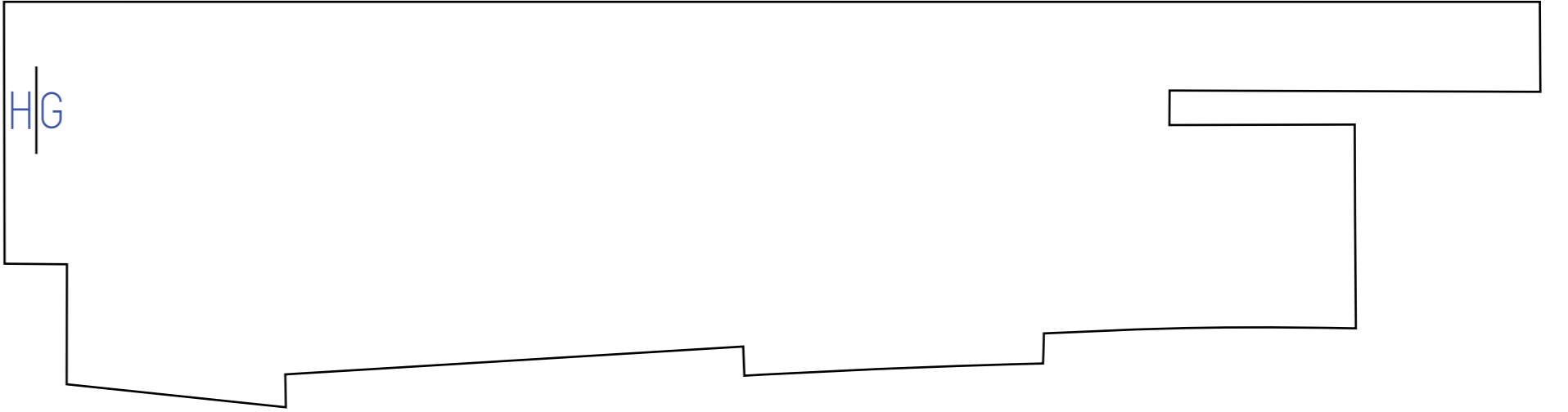

Do not glue the formers, "C & D", to the box frame because those are the formers from the nose that slides off for battery access.

Copyright ©2021 13thSquadron. All Rights Reserved.
Commercial use of our plans are prohibited.

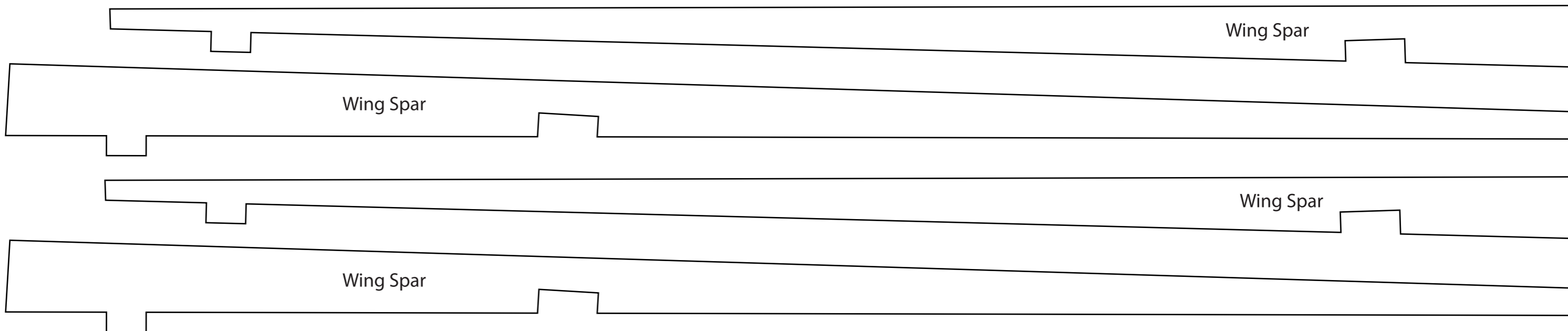
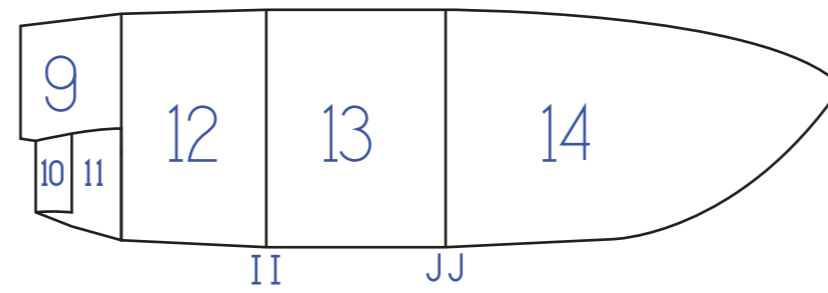
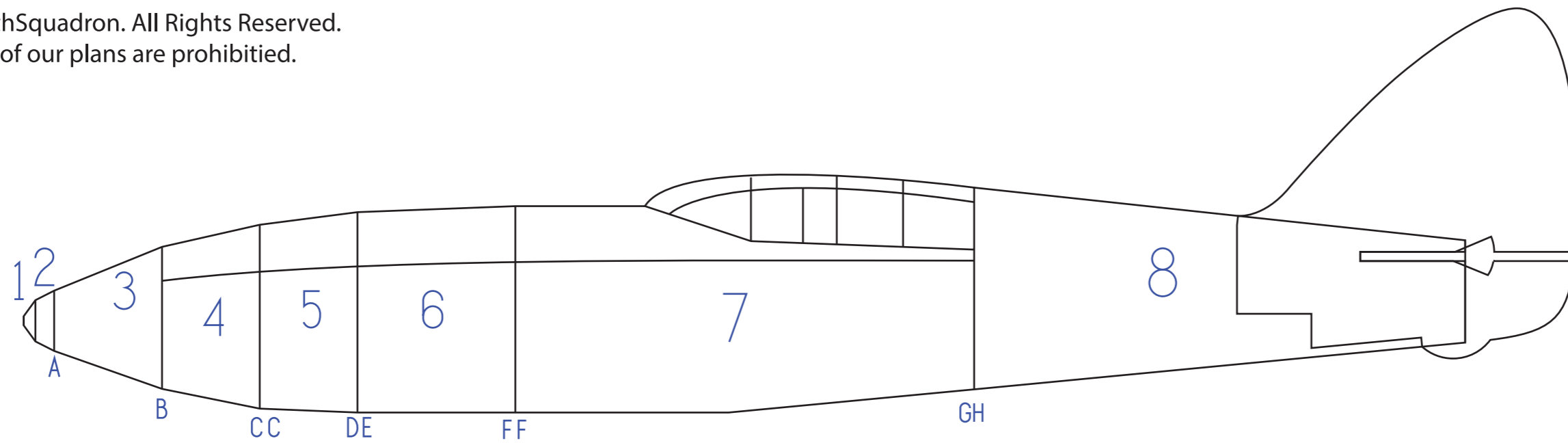

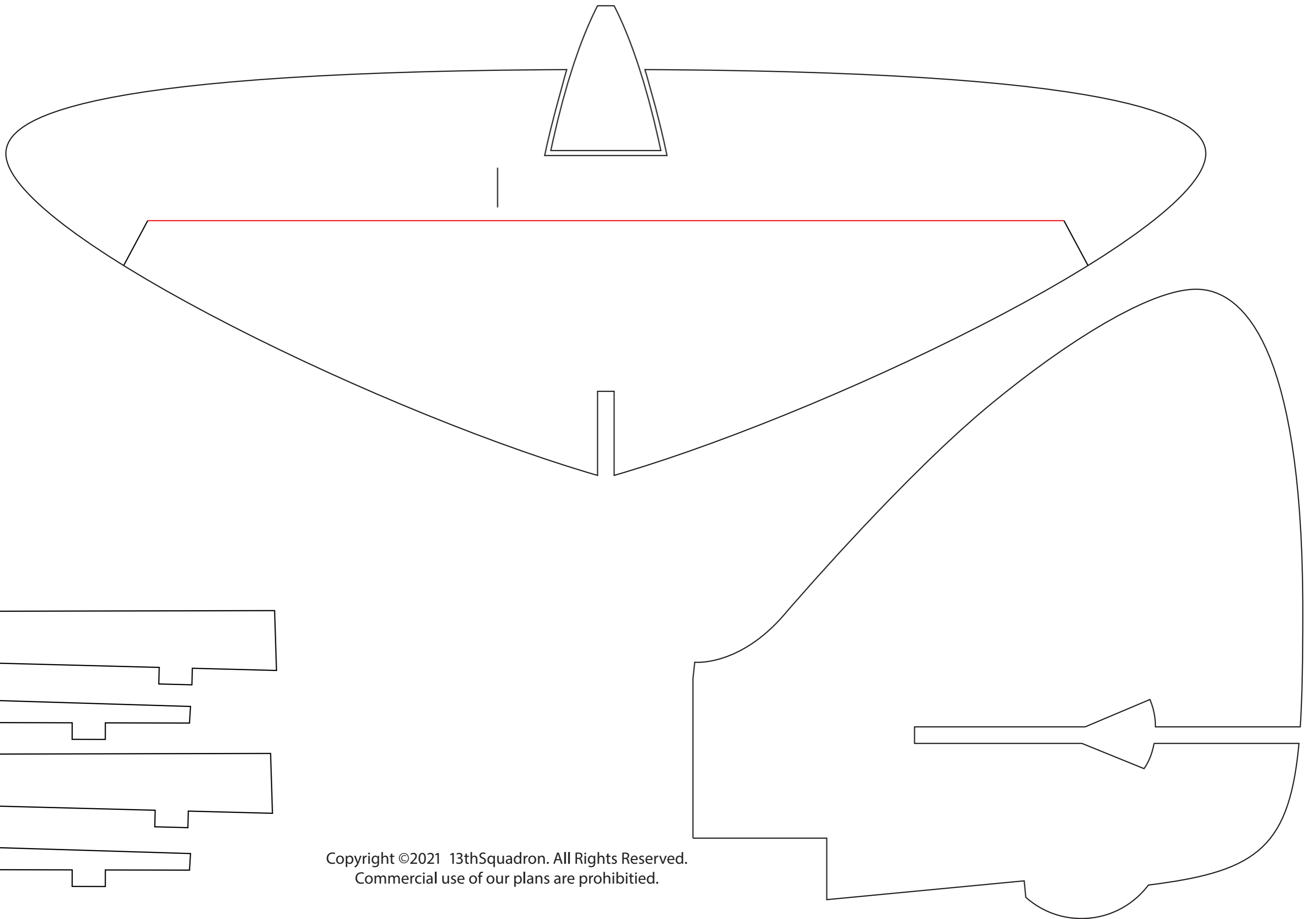

Copyright ©2021 13thSquadron. All Rights Reserved.
Commercial use of our plans are prohibited.

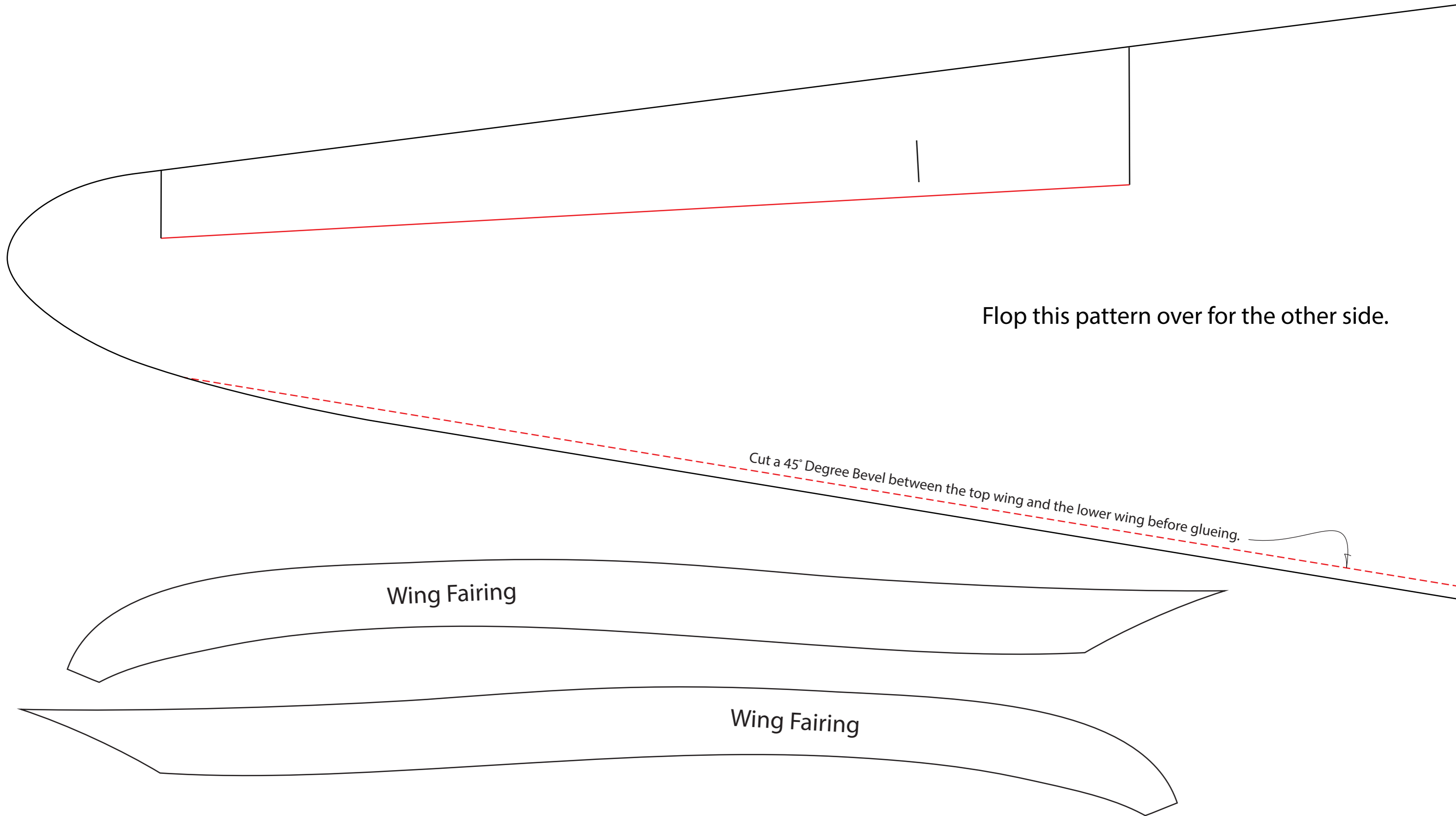

Flop this pattern over for the other side.

Cut a 45° Degree Bevel between the top wing and the lower wing before glueing.

Wing Fairing

Wing Fairing

How to glue the leading edges of the wings.

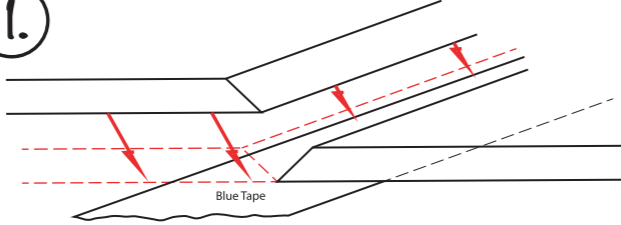
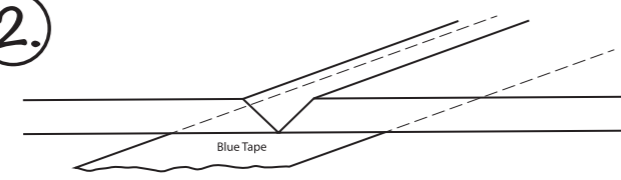
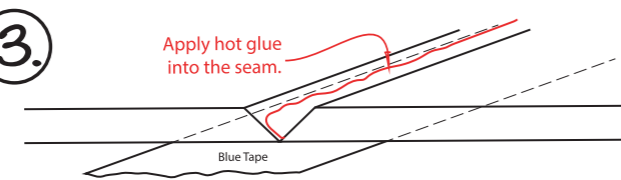
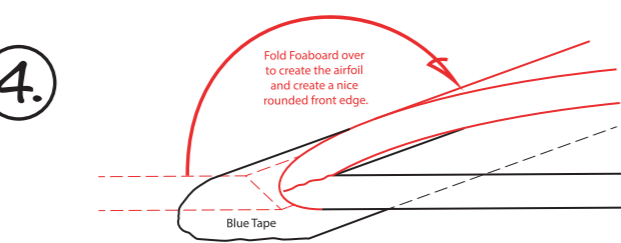
1. 
2. 
3. 
4. 

Wing Airfoil Guide Placement

Cut halfway through the foam and score so you can bend the bottom of the wing here.

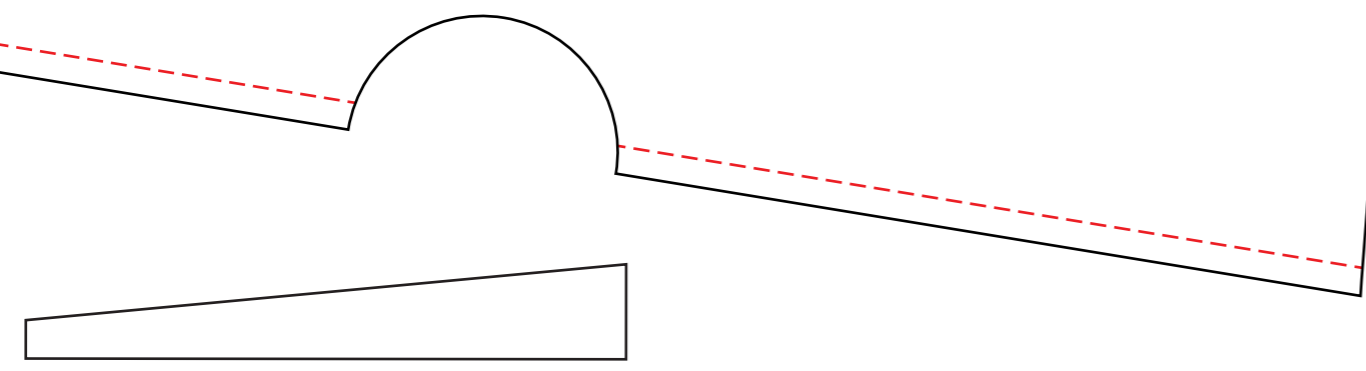
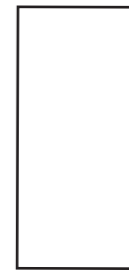

Underside Wing Bend Guide
(Does not get glued)

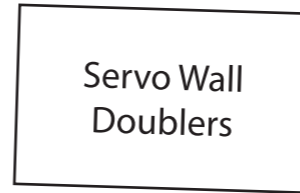
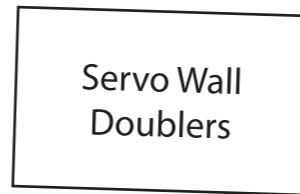
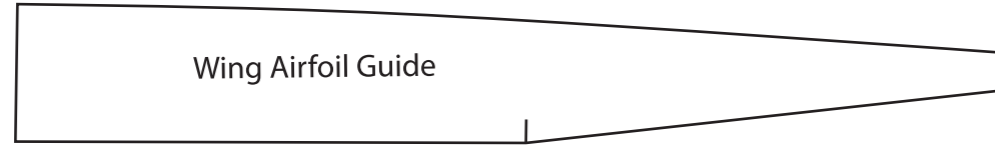
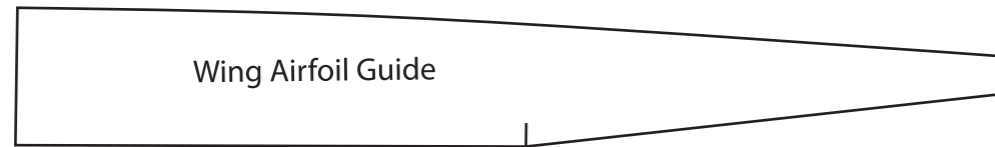

Flop this pattern over for the other side.

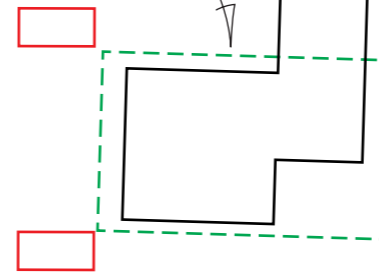

Cut a 45° Degree Bevel between the top wing and the lower wing before glueing.

You'll have excess foam here once you glue this piece to the top wing. Just trim it off once it has been glued.

Sand the foam down to the edge before glueing to the upper wing.

Nose pieces, 1, 2, 3, 4 and 5.
These all slide off the front of the plane
for battery access.

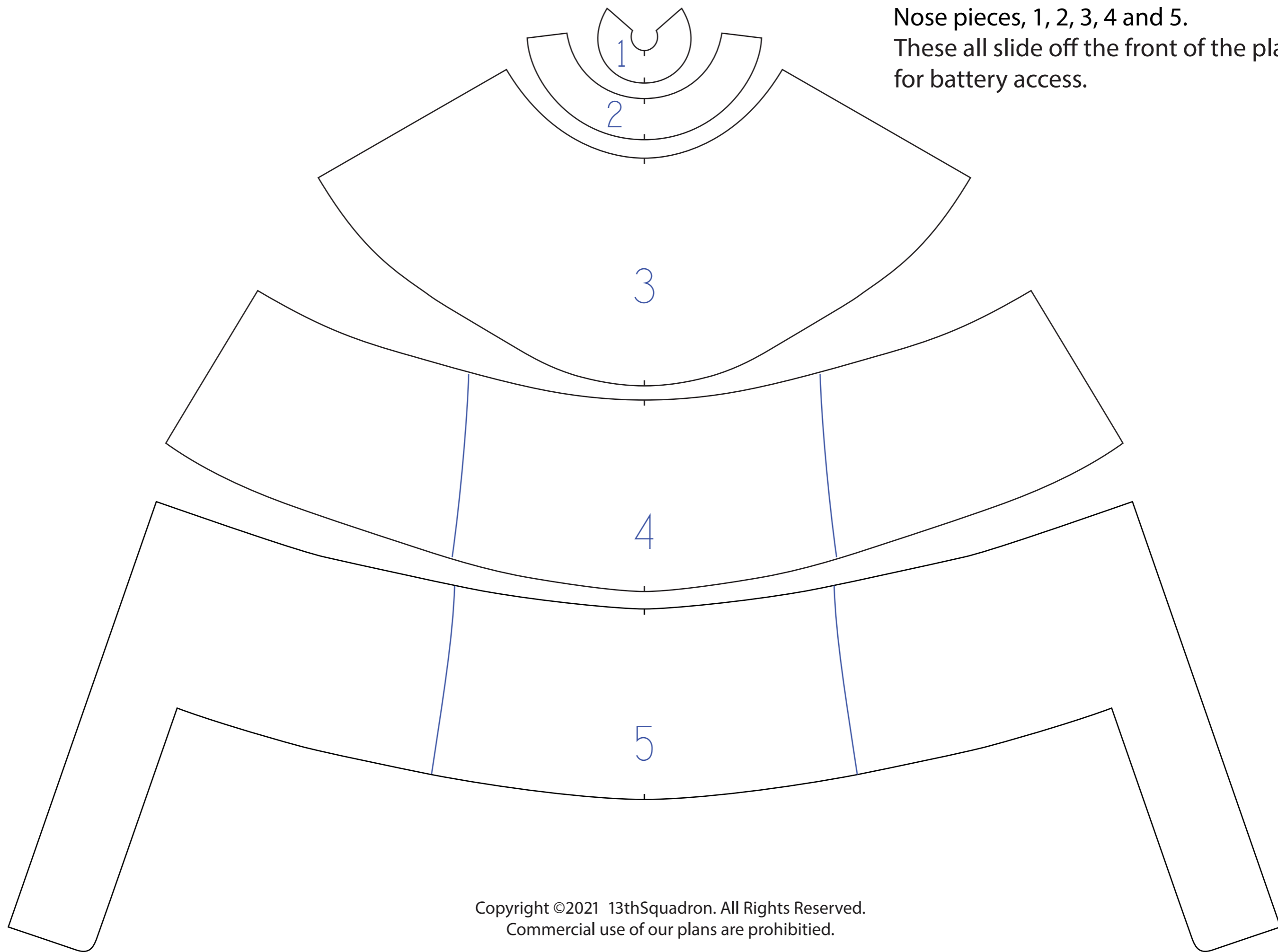

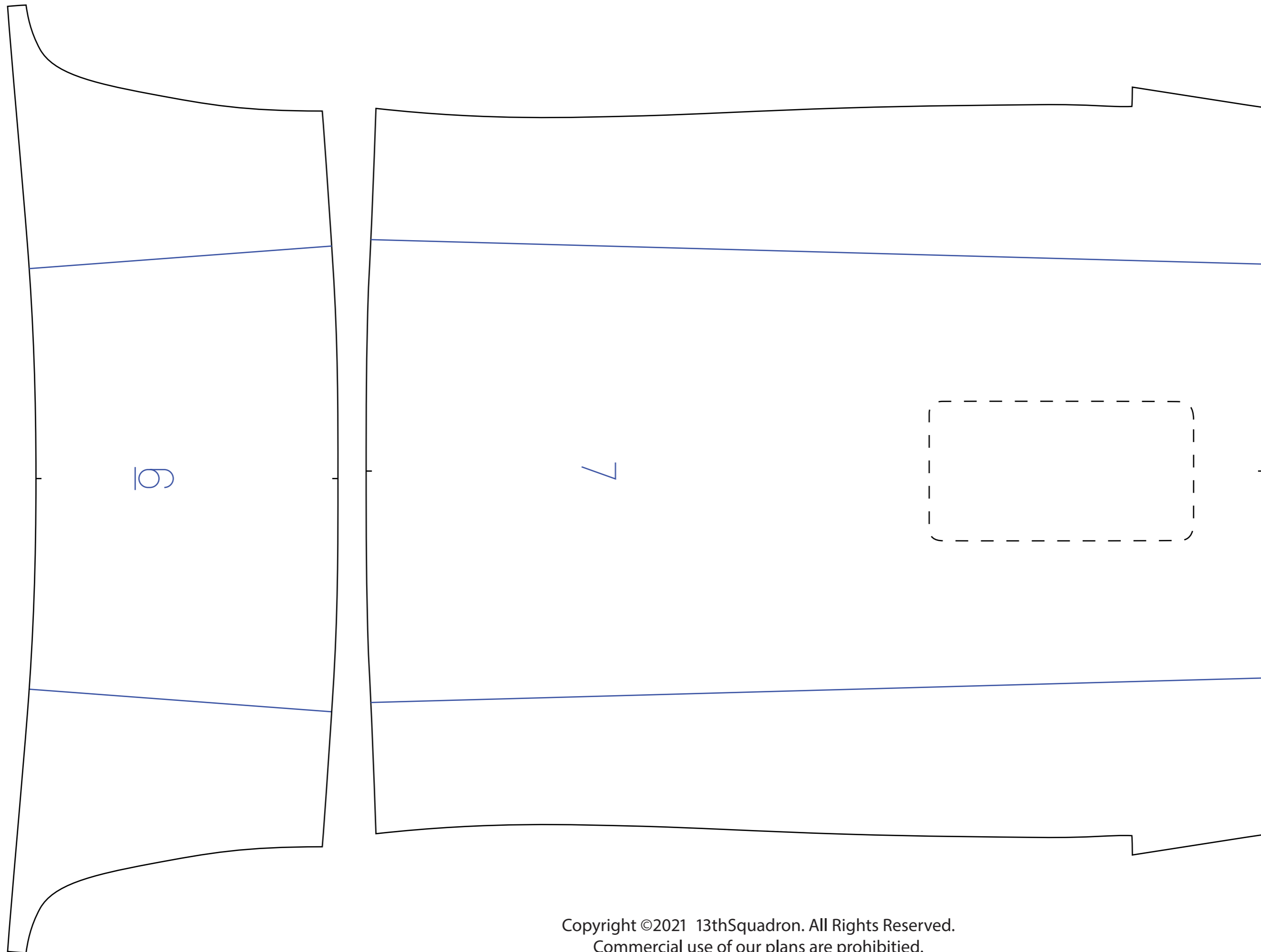

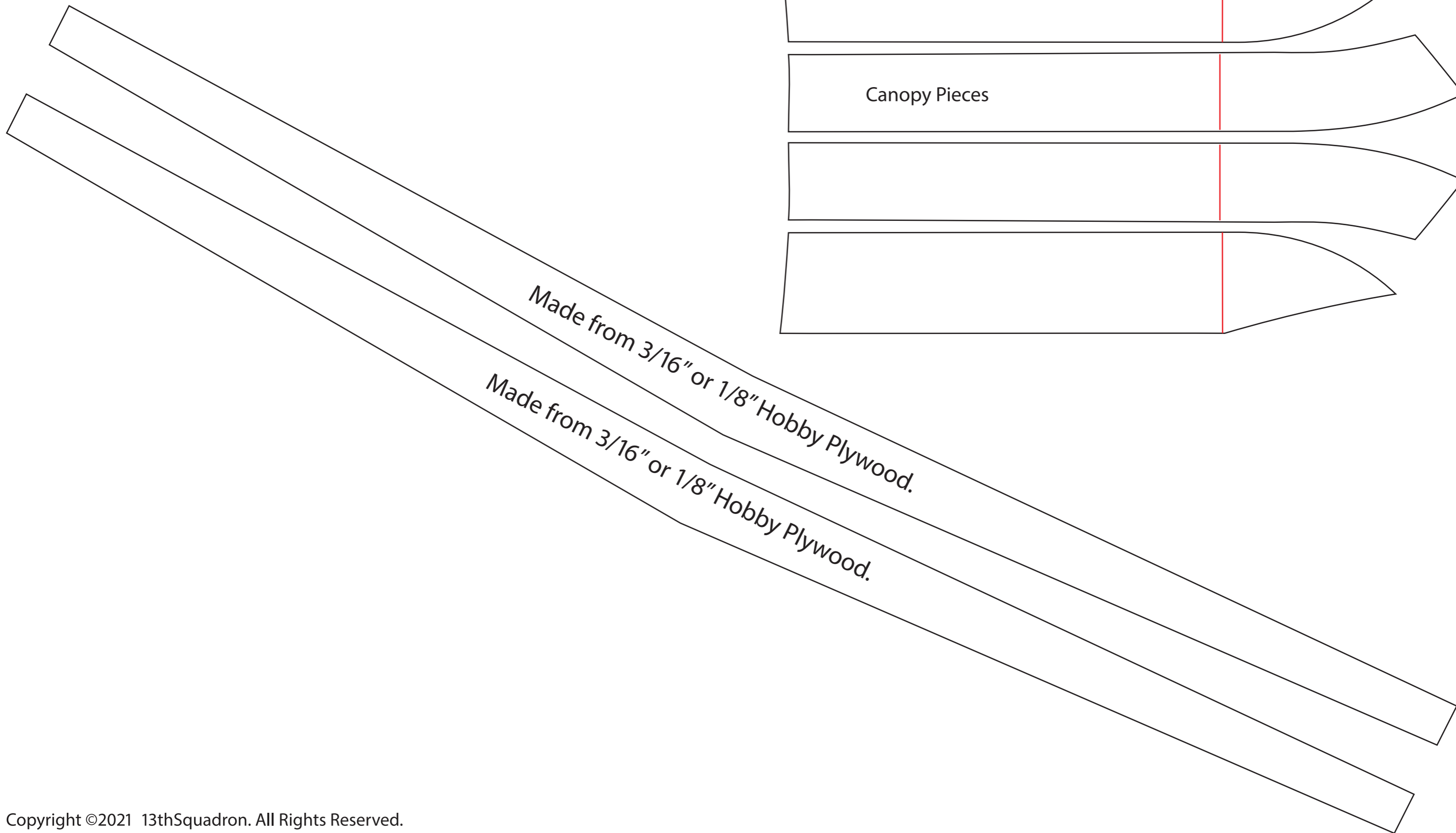

We made a "skid" here out of wood that we cut on a jigsaw and glued to the foamboard.

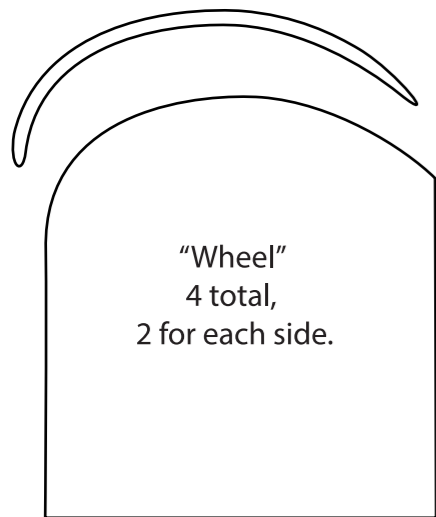

Trim the foam on the backside to a point on this piece. You have to do this to make room for the motor mount.

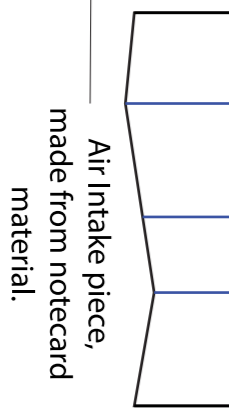
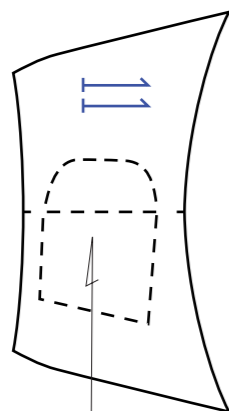
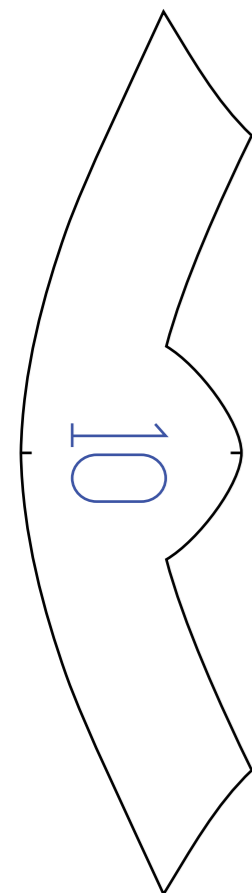
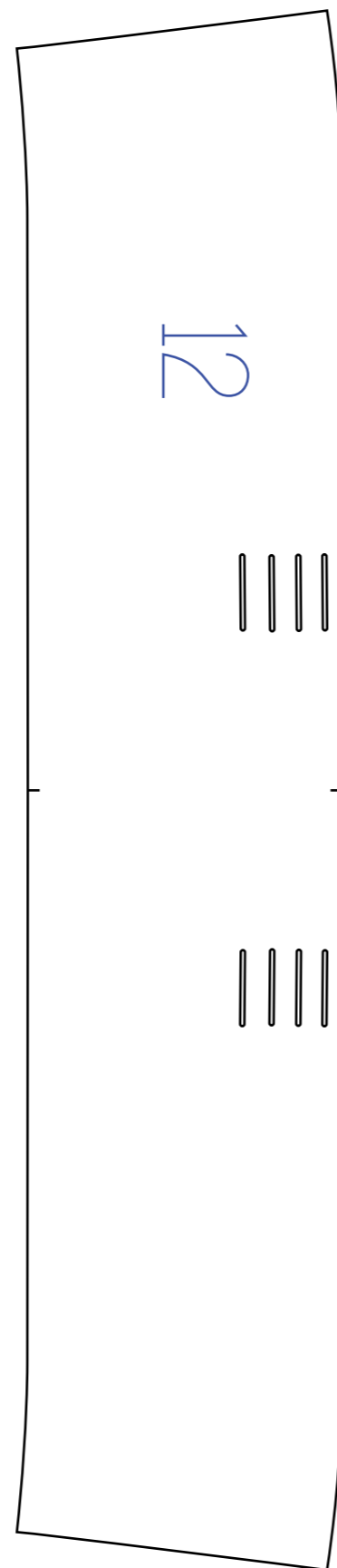
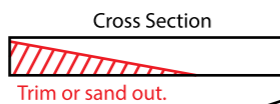

Use all of these pieces for the other nacelle but flop pieces, "13 & 14", over for the other side.

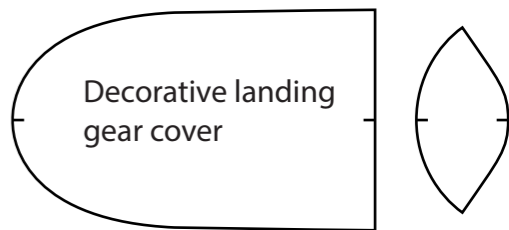
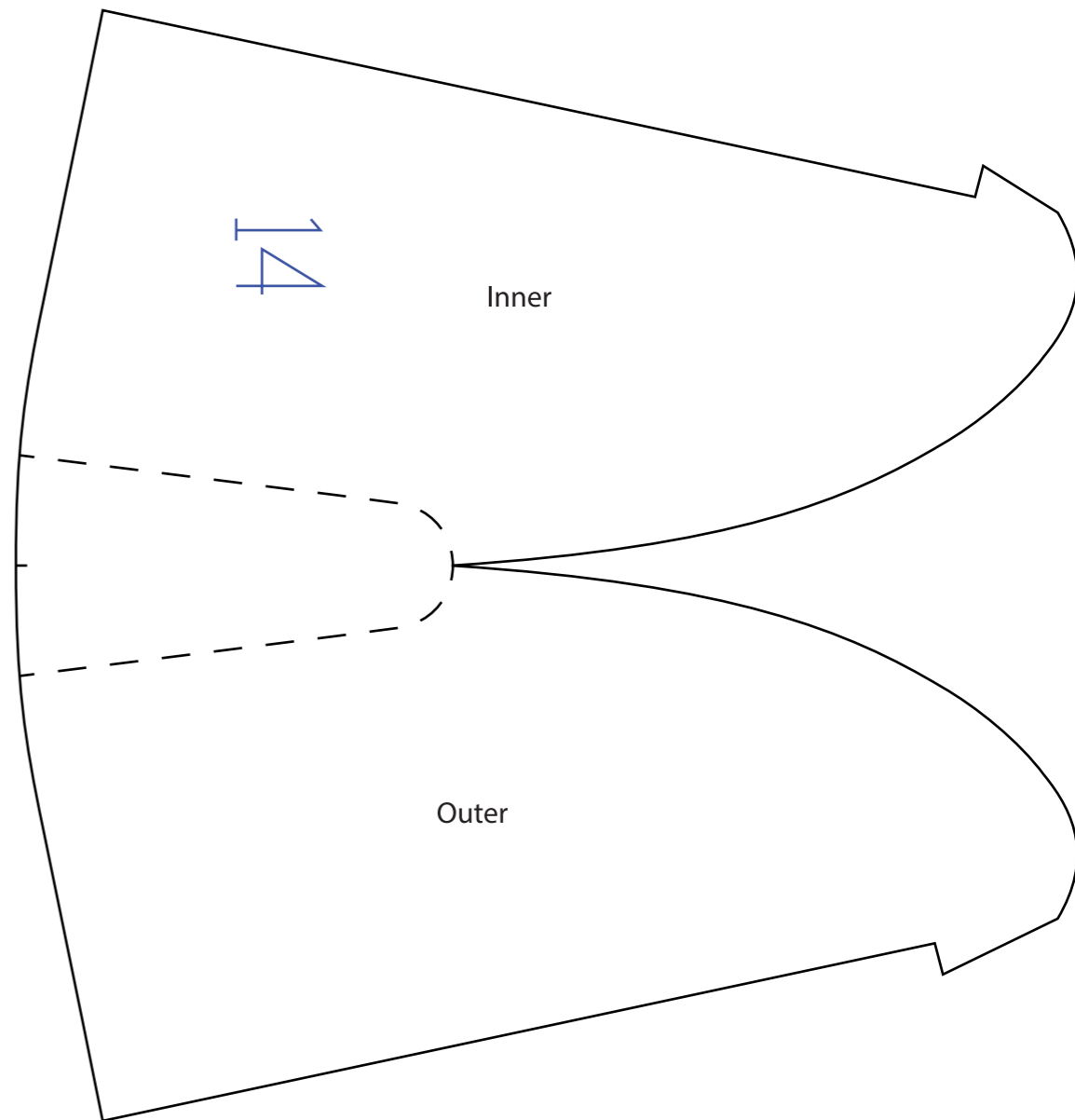
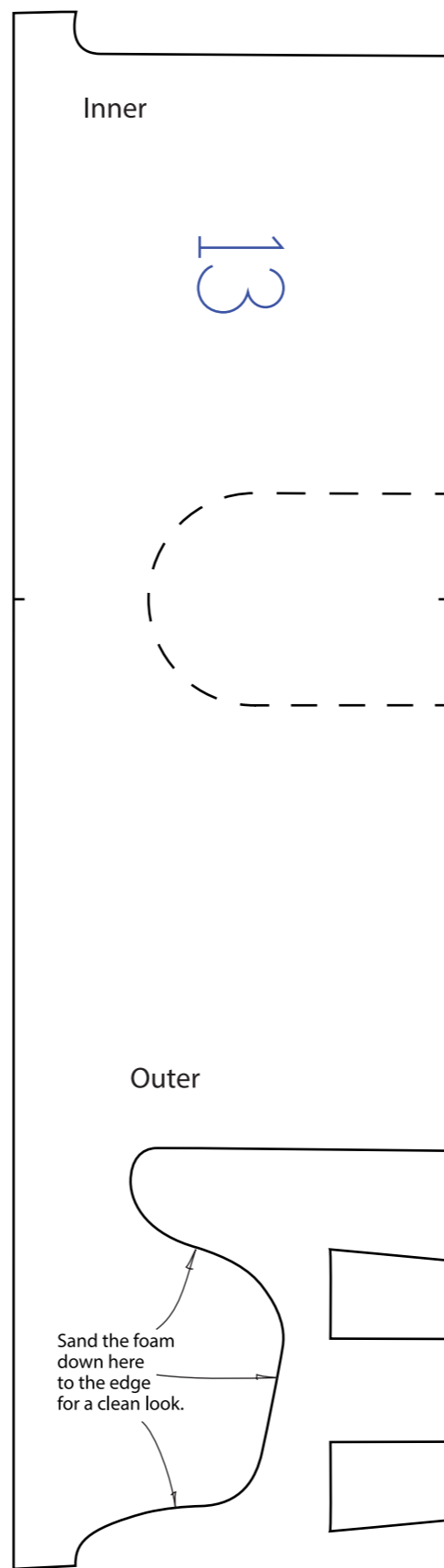

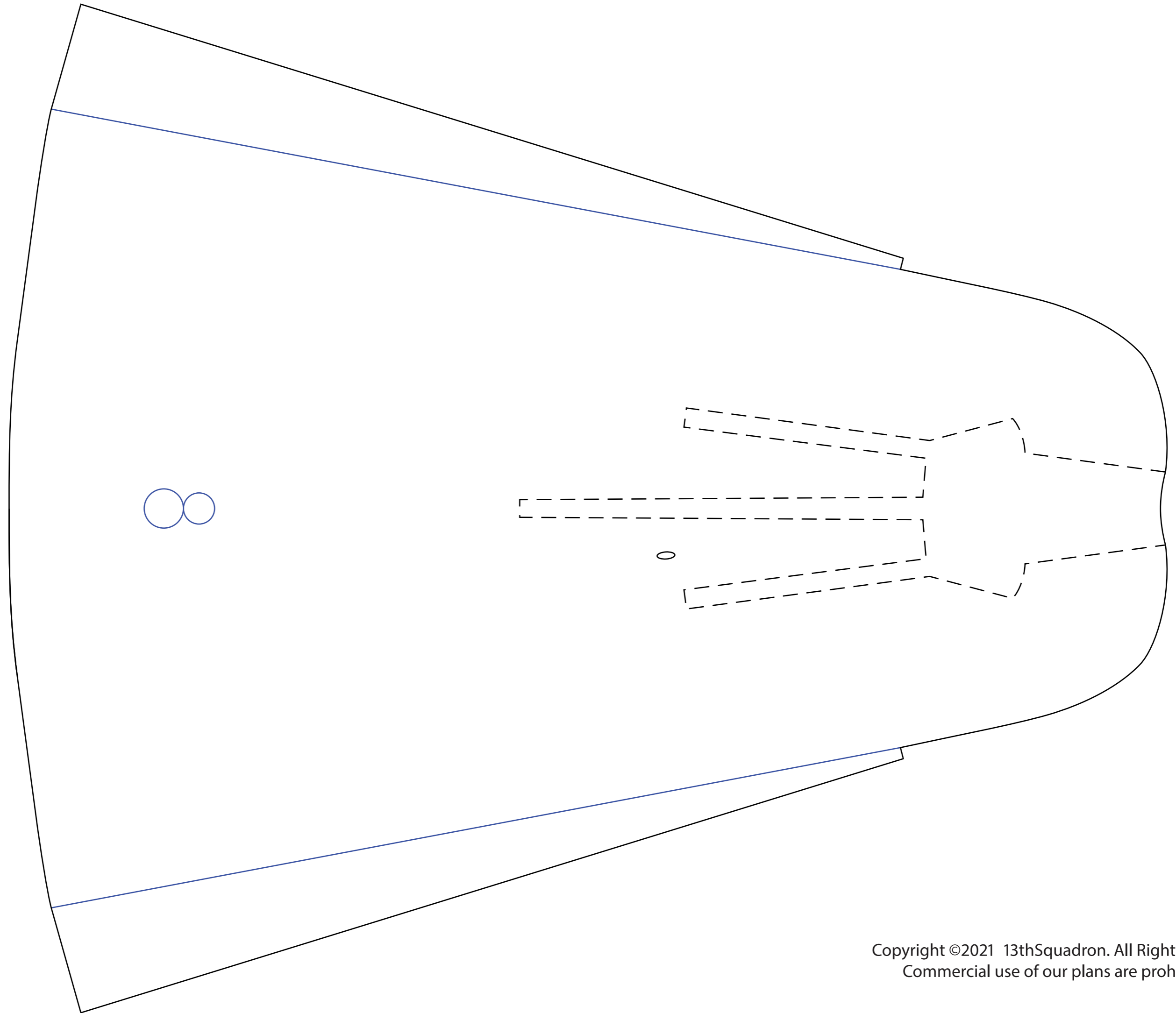

G

I

A

13

13

G

S

S

G-A-GSS

G-A-GSS

**THIRTEENTH SQUADRON
GROSVENOR HOUSE**

Bottom Letters

A

C

G

-

S

S