

Flop this pattern over for the other wing

Peel paper in this area

Don't peel paper in this area

Don't peel paper in this area

Copyright ©2020 13thSquadron. All Rights Reserved.
Commercial use of our plans are prohibited.

We have also suggested that if you can think of a new way to do the hatch we highly recommend doing that because the way we did it is difficult.

This piece is for the hatch.

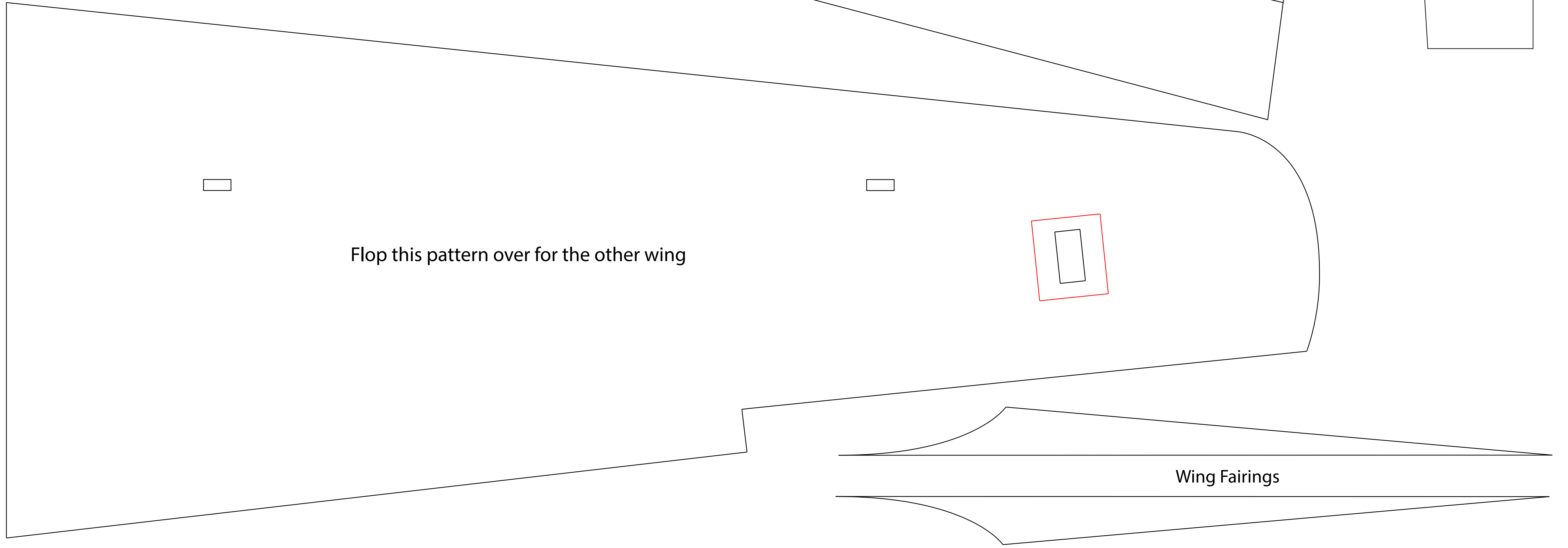

Flop this pattern over for the other wing

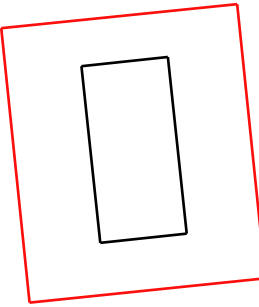

Wing Fairings

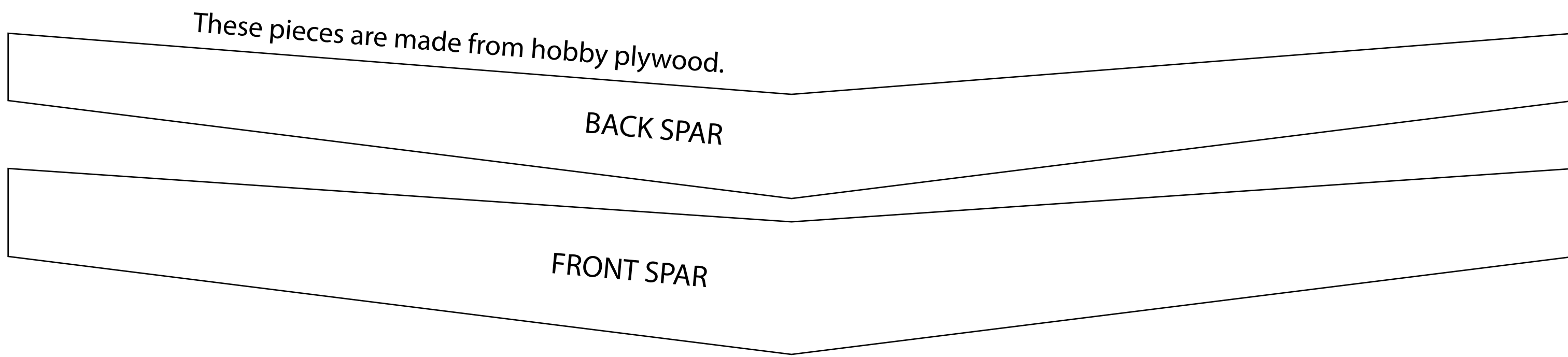
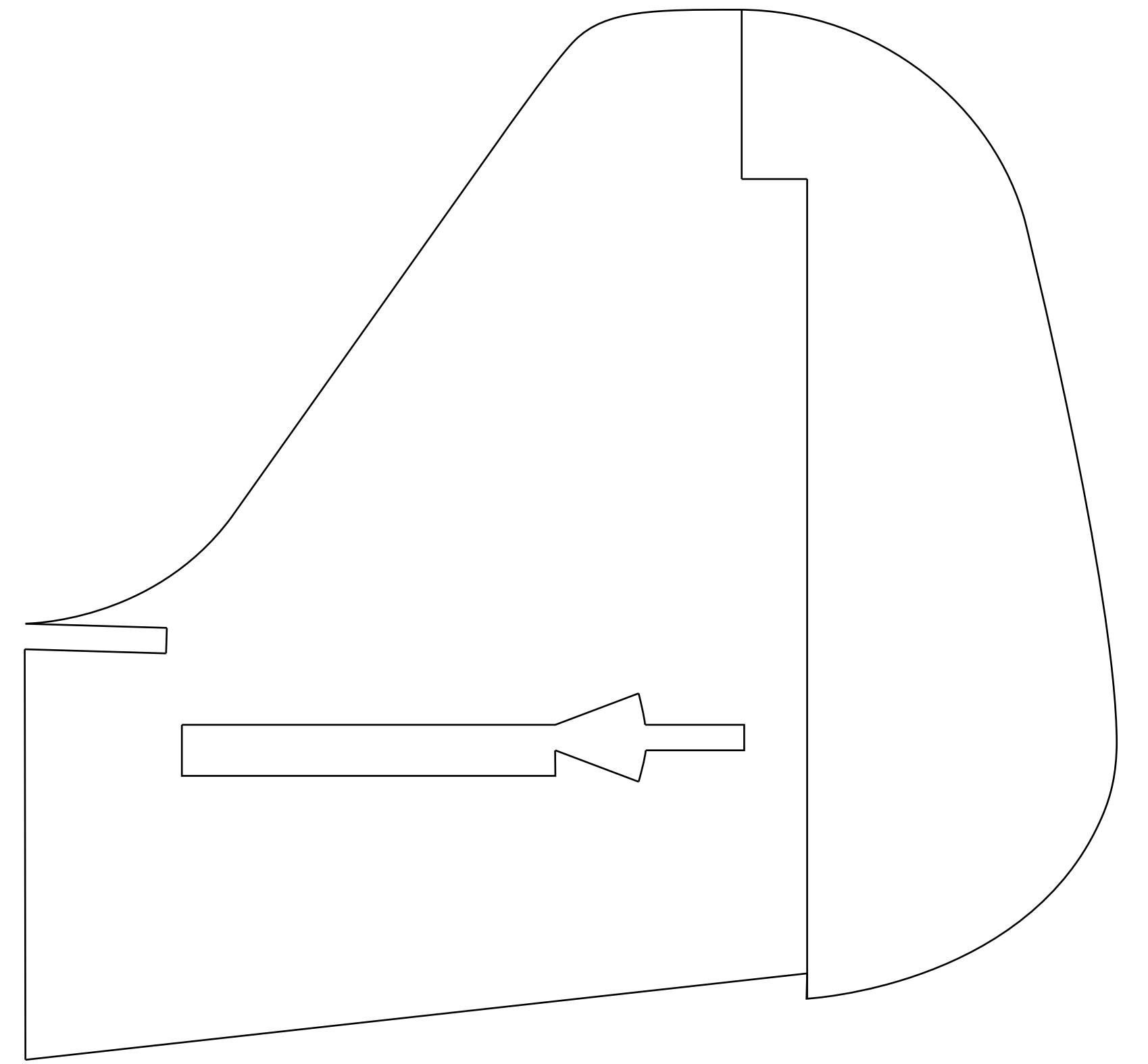
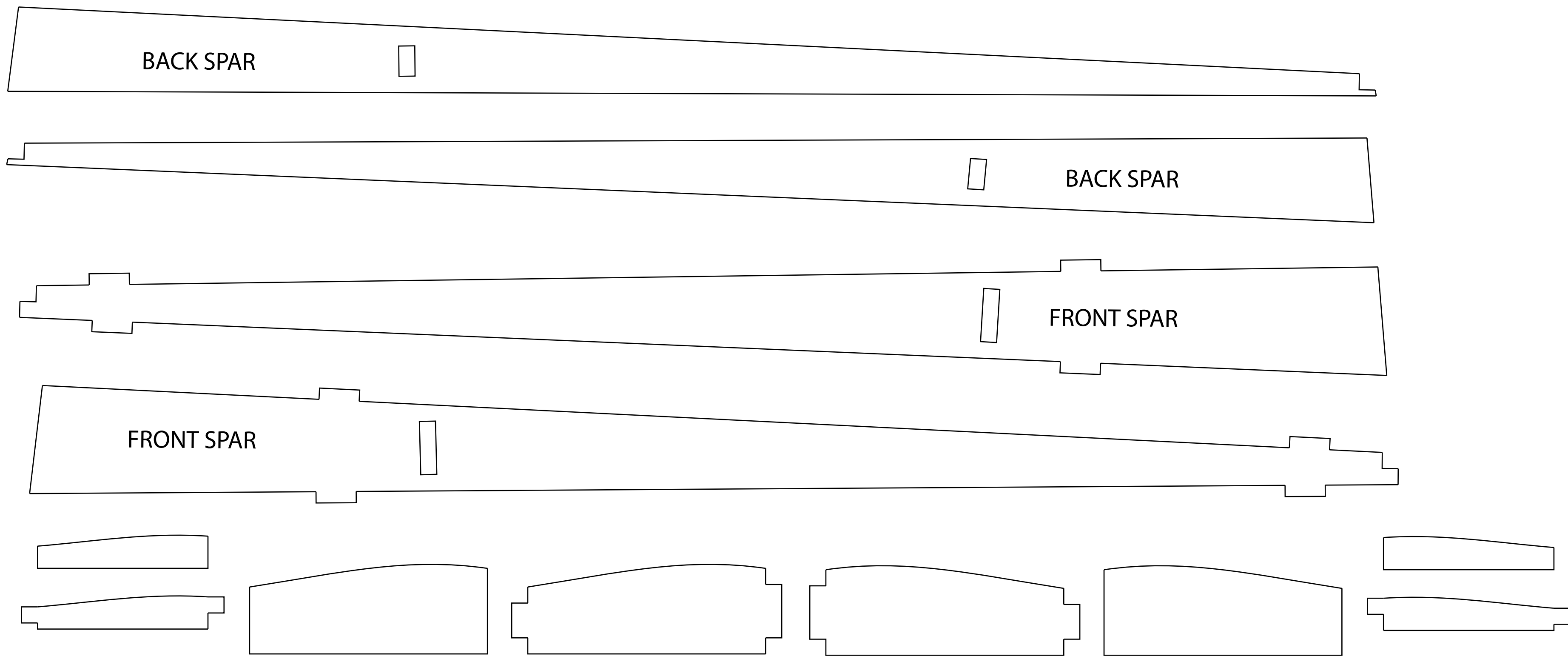

Copyright ©2020 13thSquadron. All Rights Reserved.
Commercial use of our plans are prohibited.

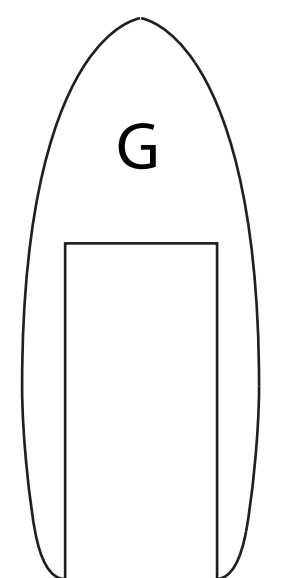
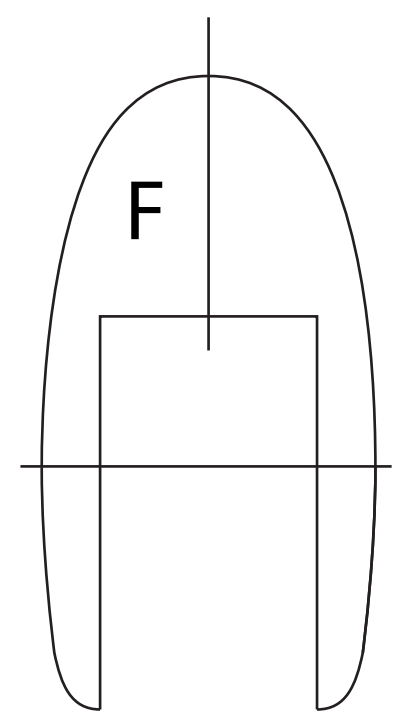
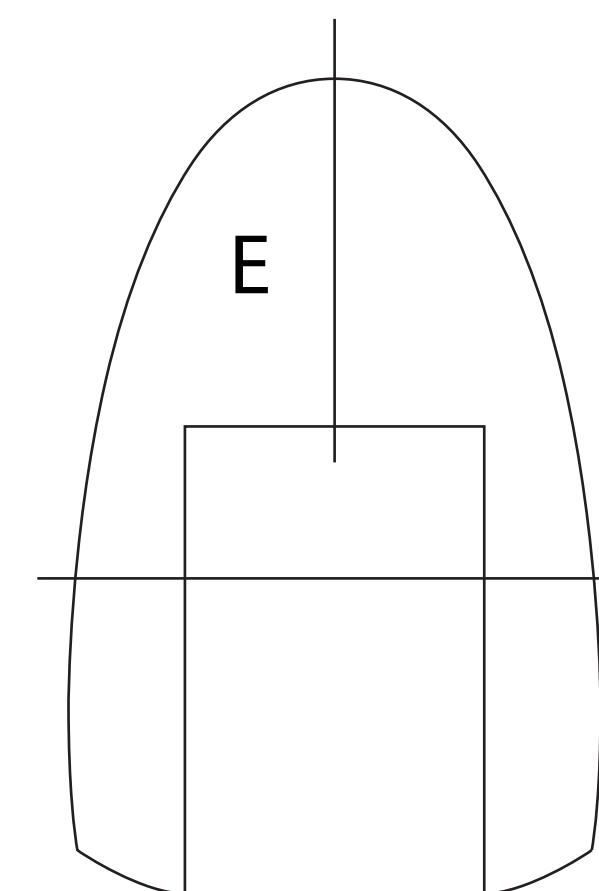
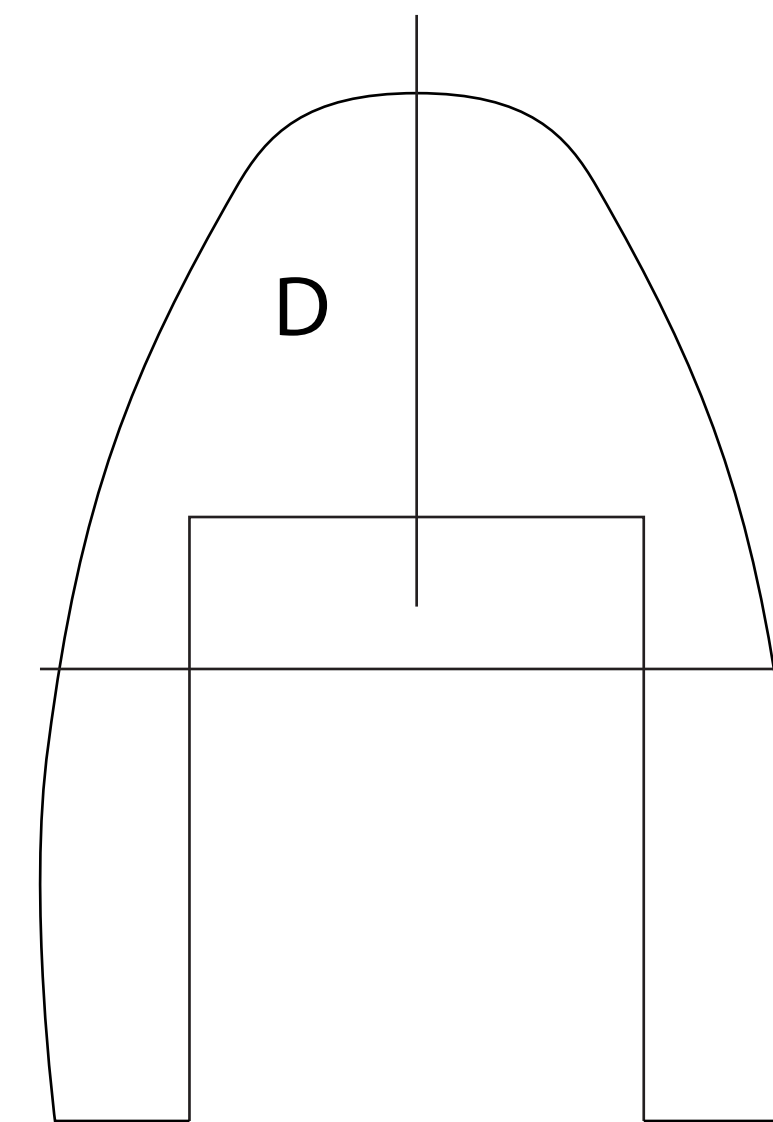
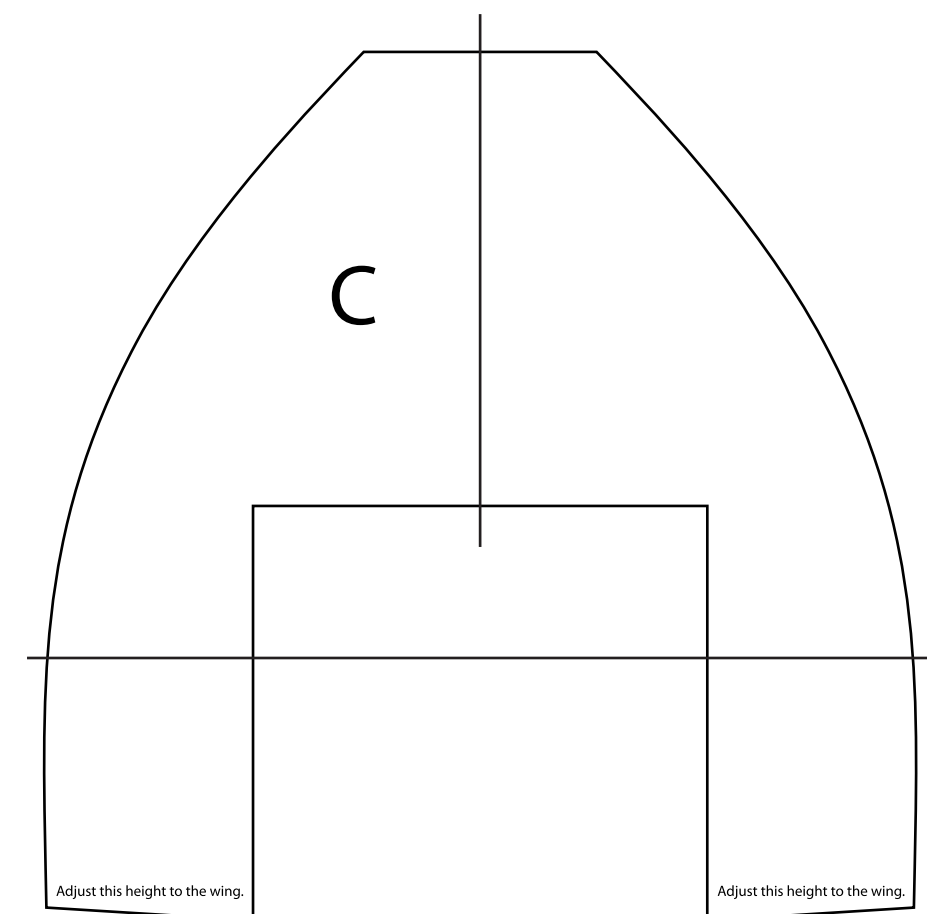
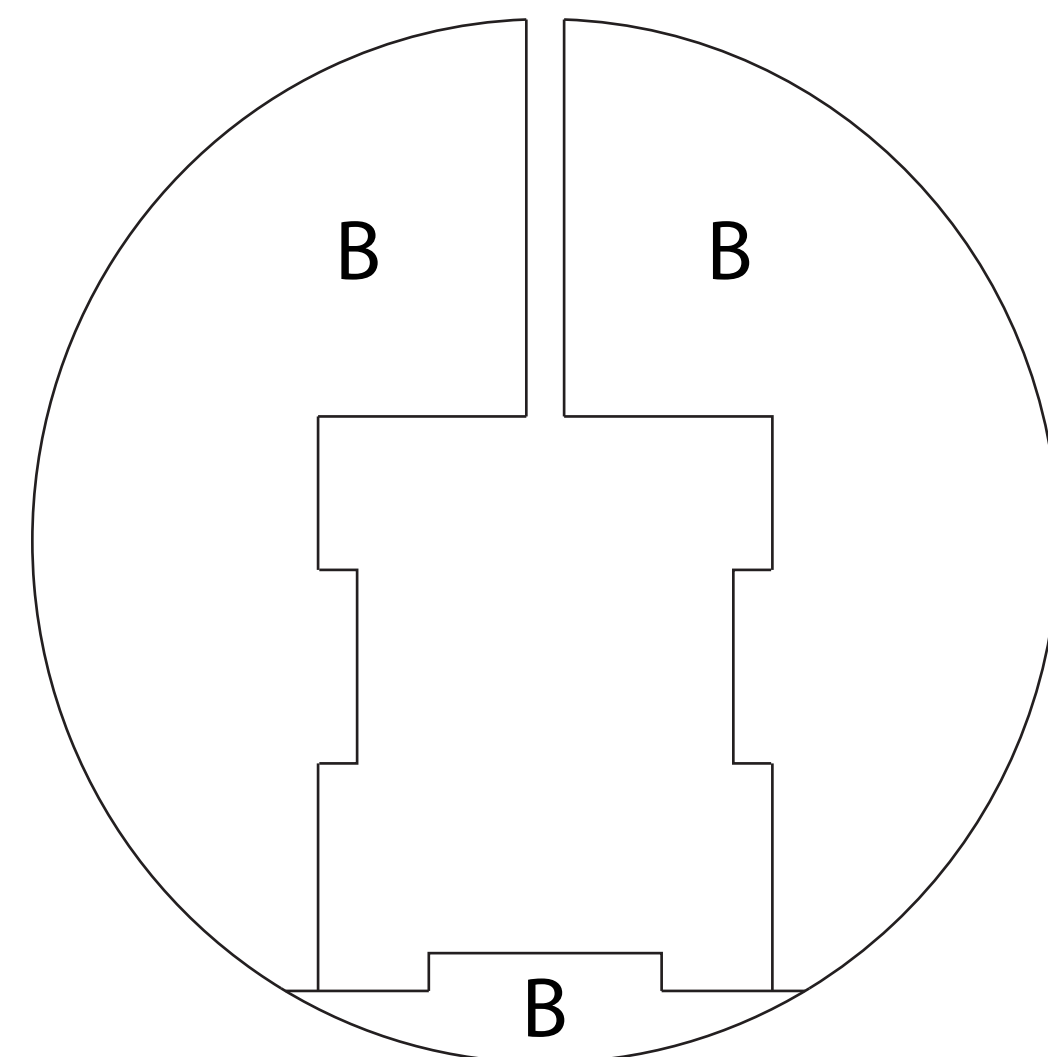
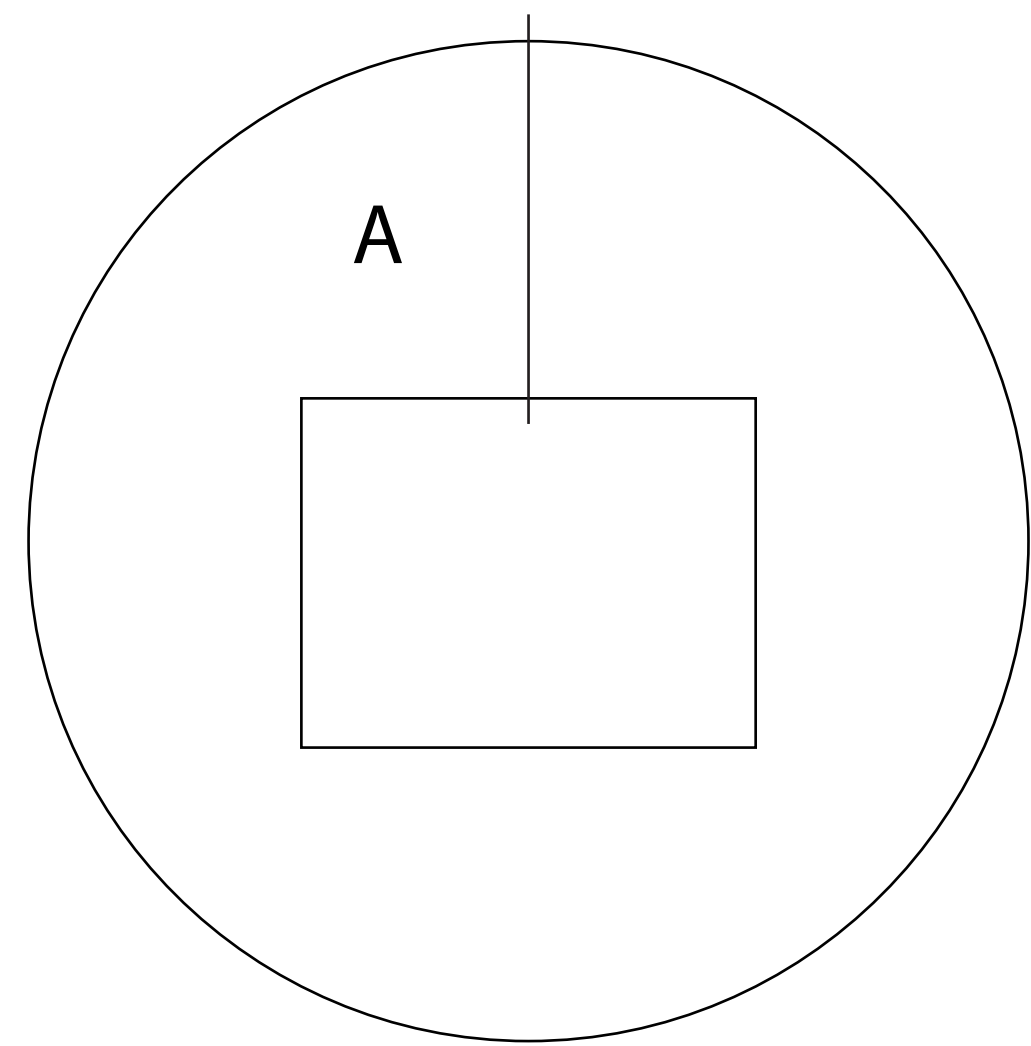

The Power Pod is the new Flite Test FT Corsiar Power Pack

This piece goes on the bottom of the fuselage behind the wing and to the rudder.

This piece goes on the bottom of the fuselage in the front, on the angle.

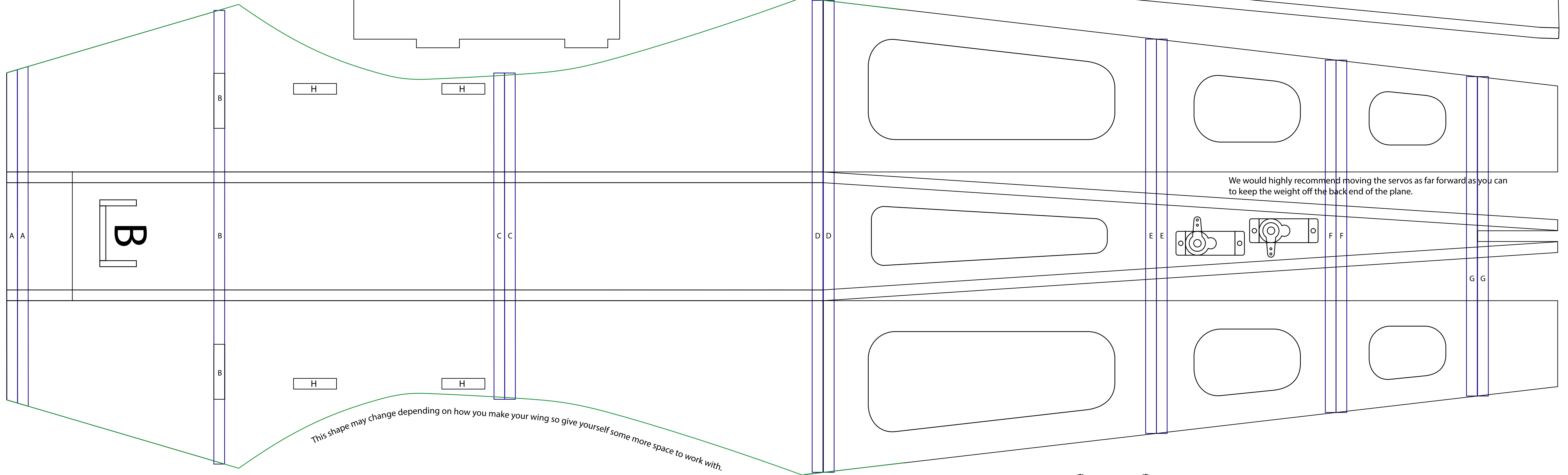
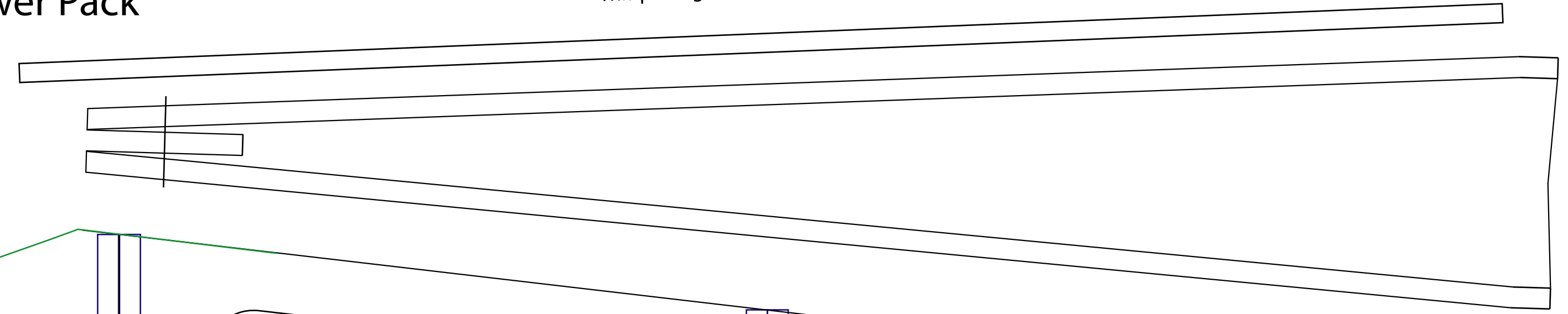
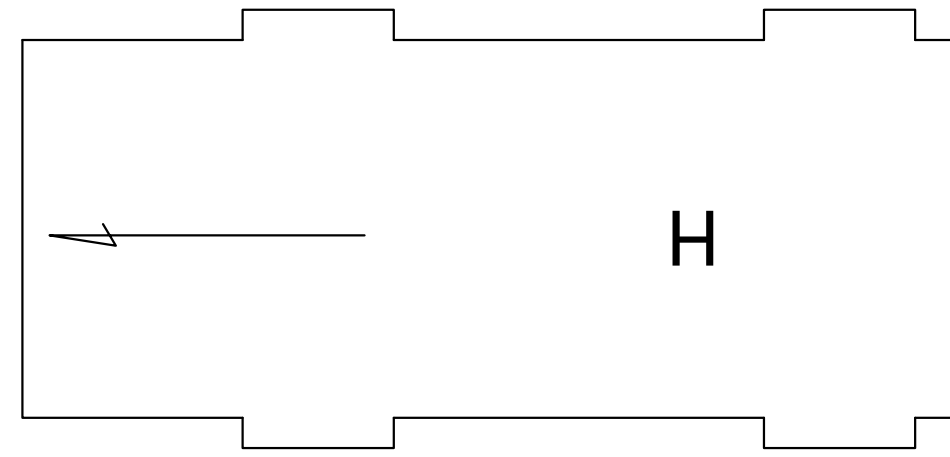
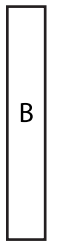

This diagram shows the main fuselage assembly with top and bottom views. It includes various cutouts for servos and a battery. Labels A through G indicate different sections and slots. A green line highlights the wing attachment area. A note states: "This shape may change depending on how you make your wing so give yourself some more space to work with."

We would highly recommend moving the servos as far forward as you can to keep the weight off the back end of the plane.

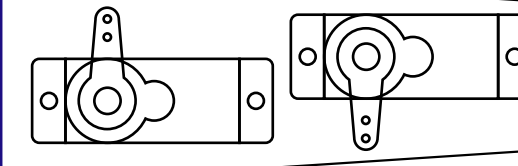

Copyright ©2020 13thSquadron. All Rights Reserved.
Commercial use of our plans are prohibited.

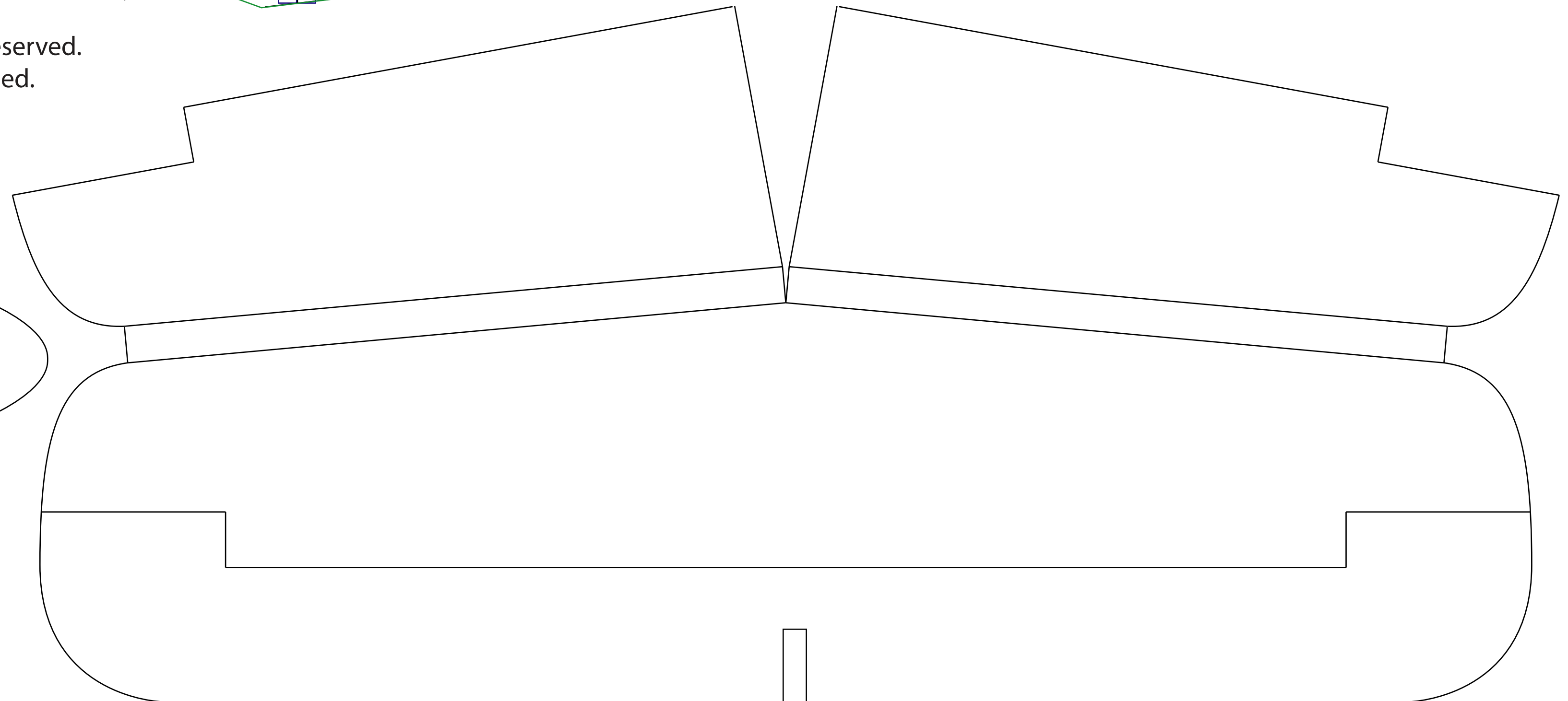
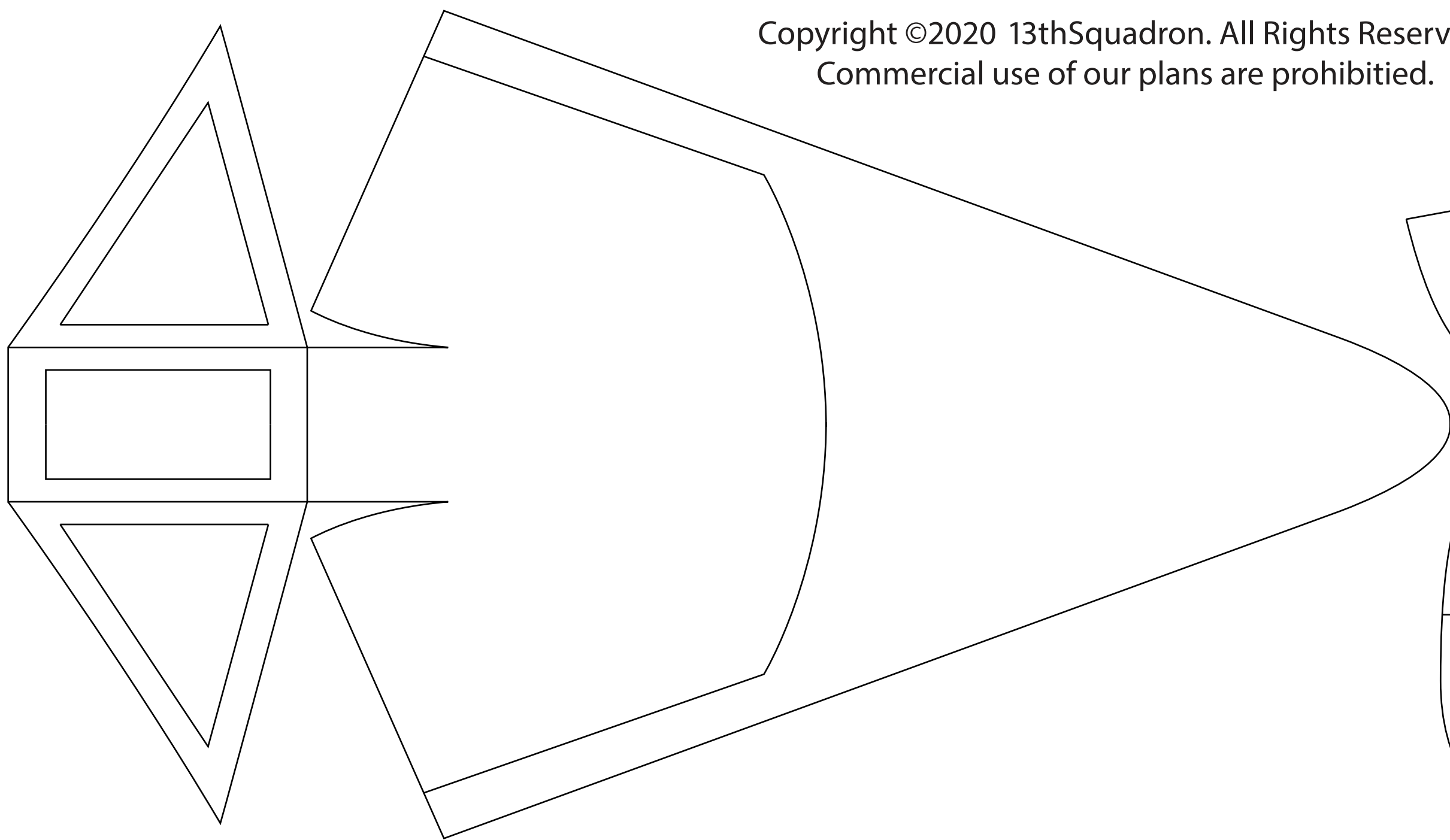

Copyright ©2020 13thSquadron. All Rights Reserved.
Commercial use of our plans are prohibited.

You might want to cut the length of the fuselage covering pieces a little
"longer" for any adjustments that might be needed.

A

B

C

D

E

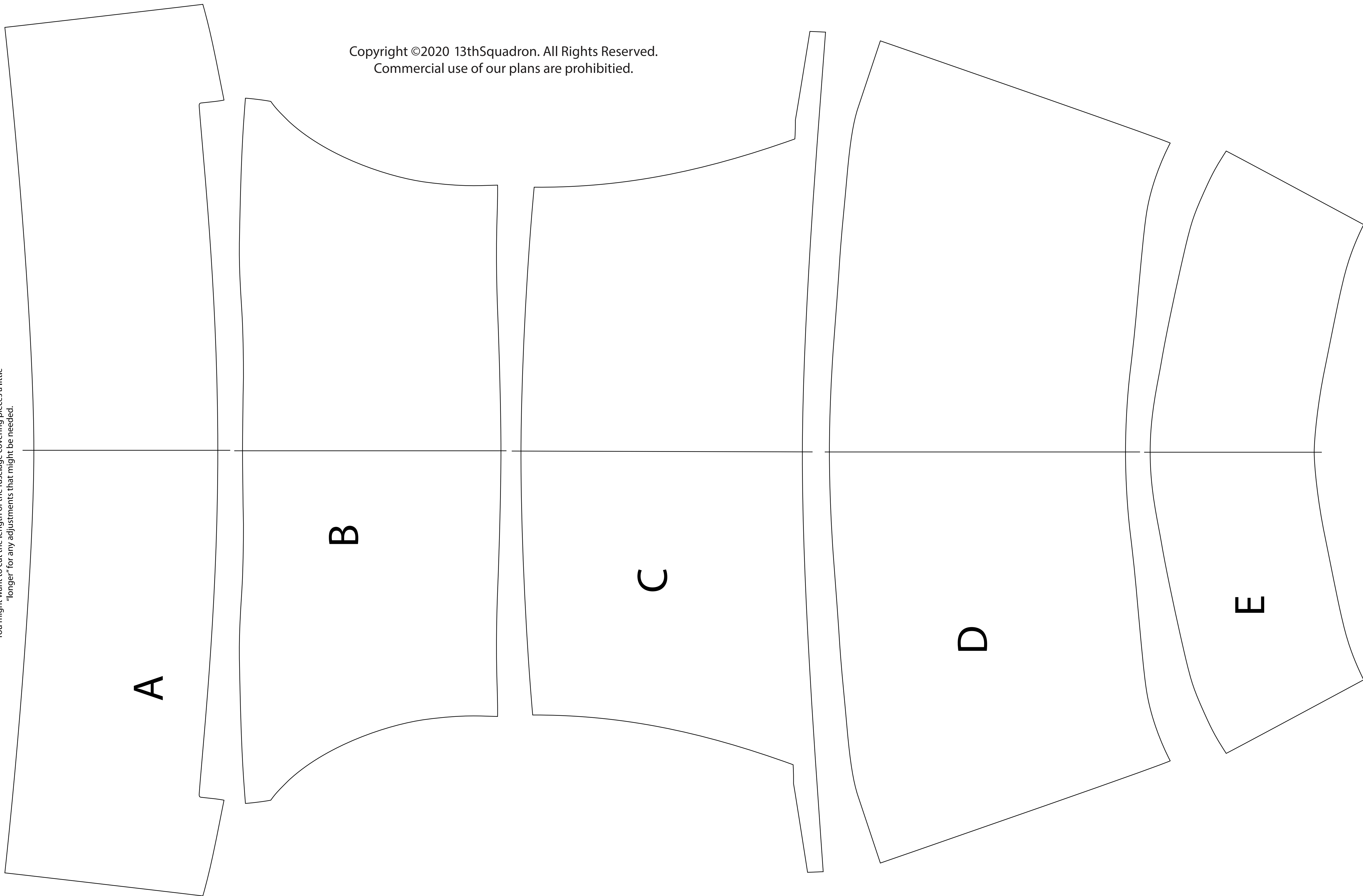

Copyright ©2020 13thSquadron. All Rights Reserved.
Commercial use of our plans are prohibited.

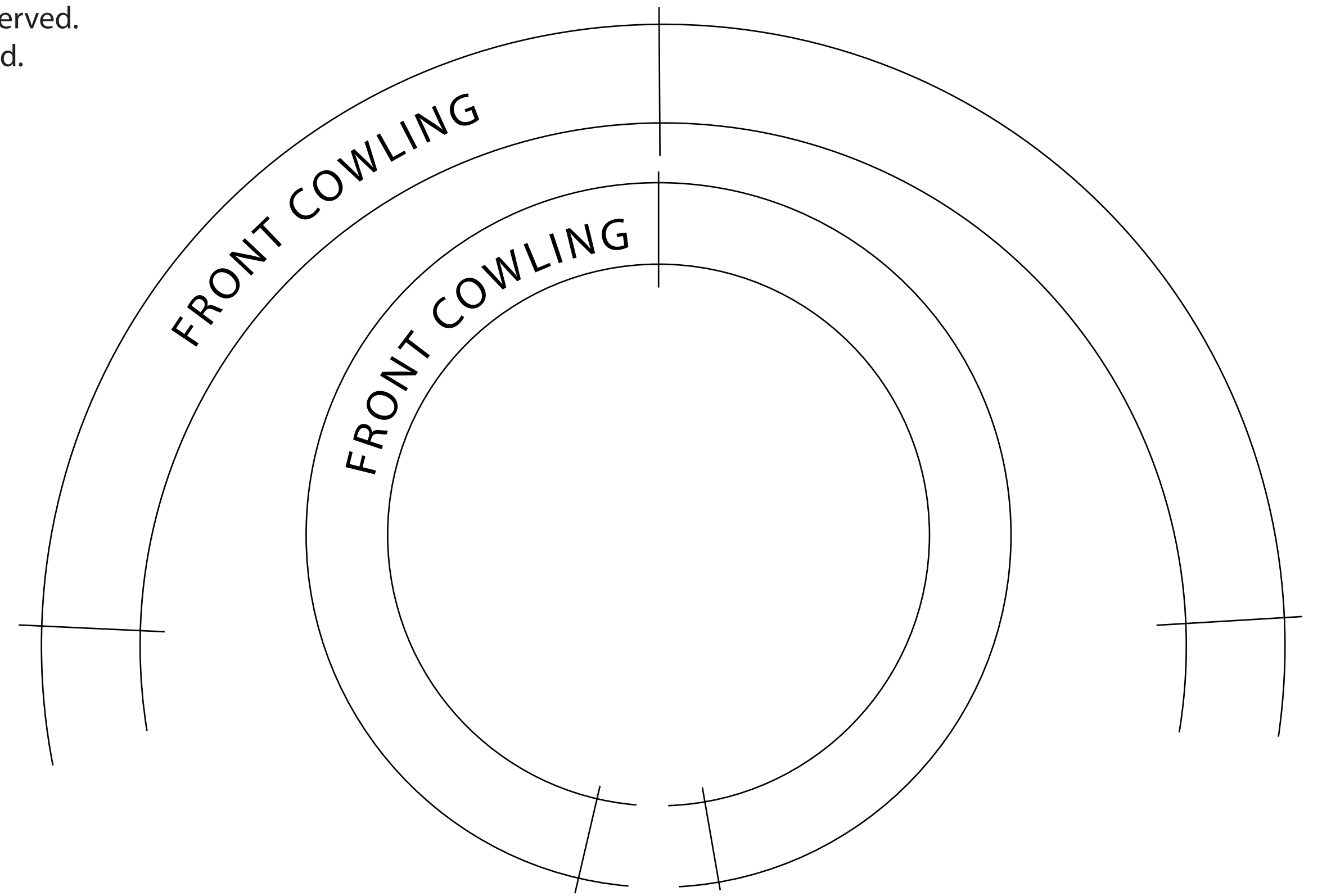
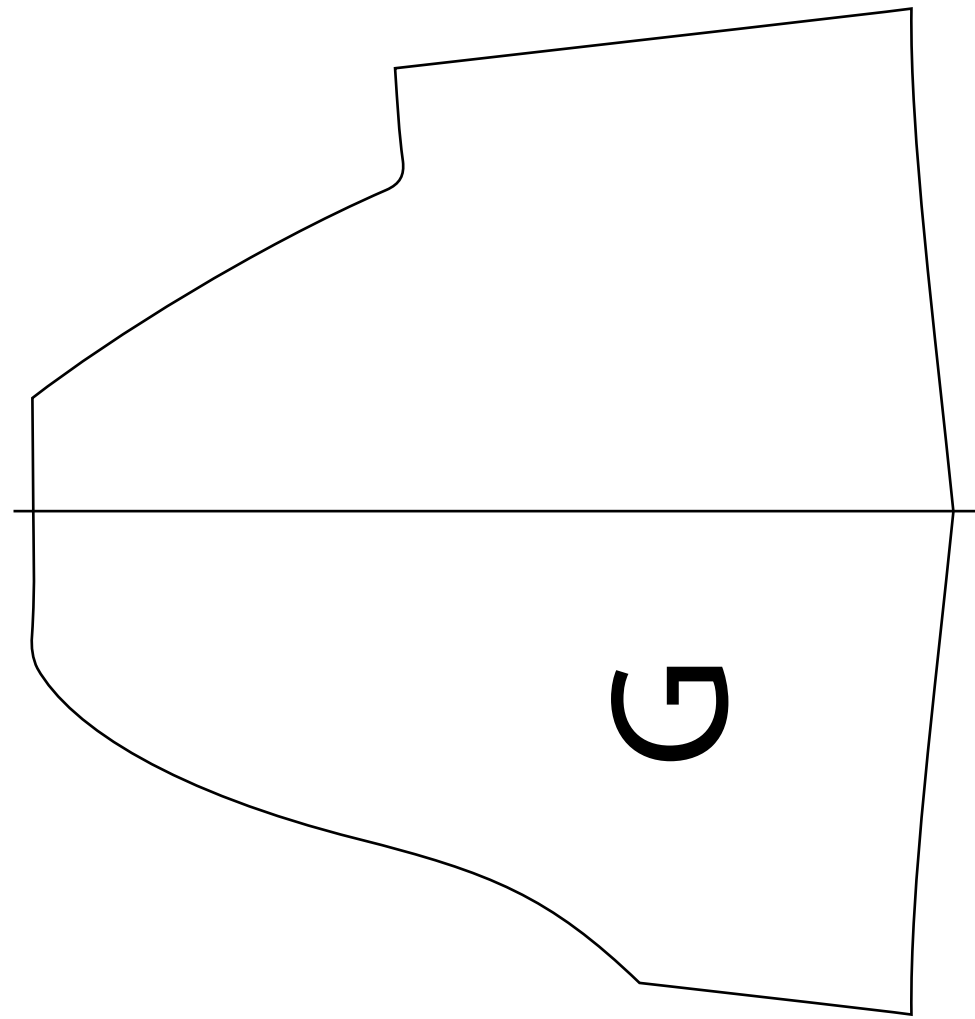
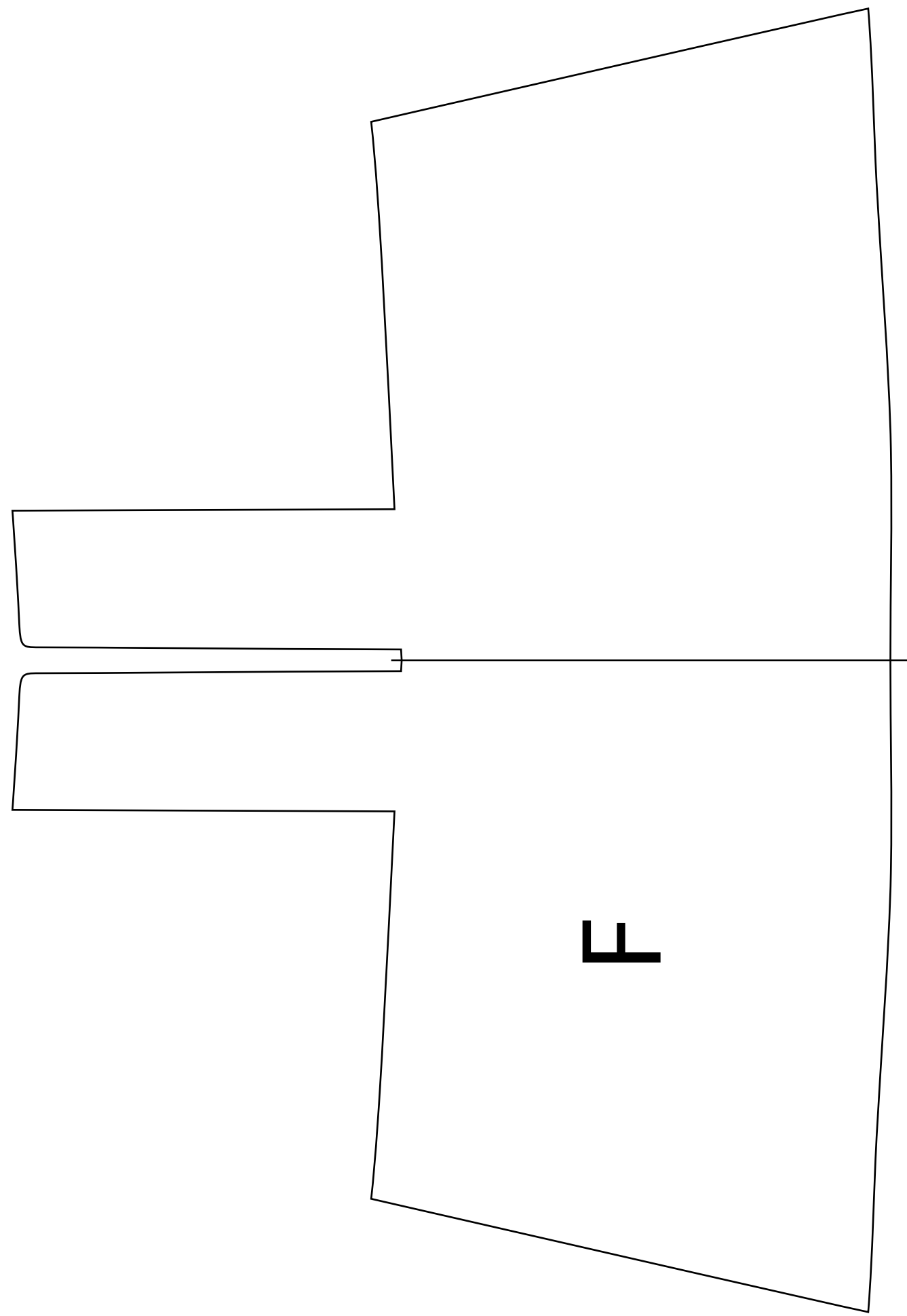

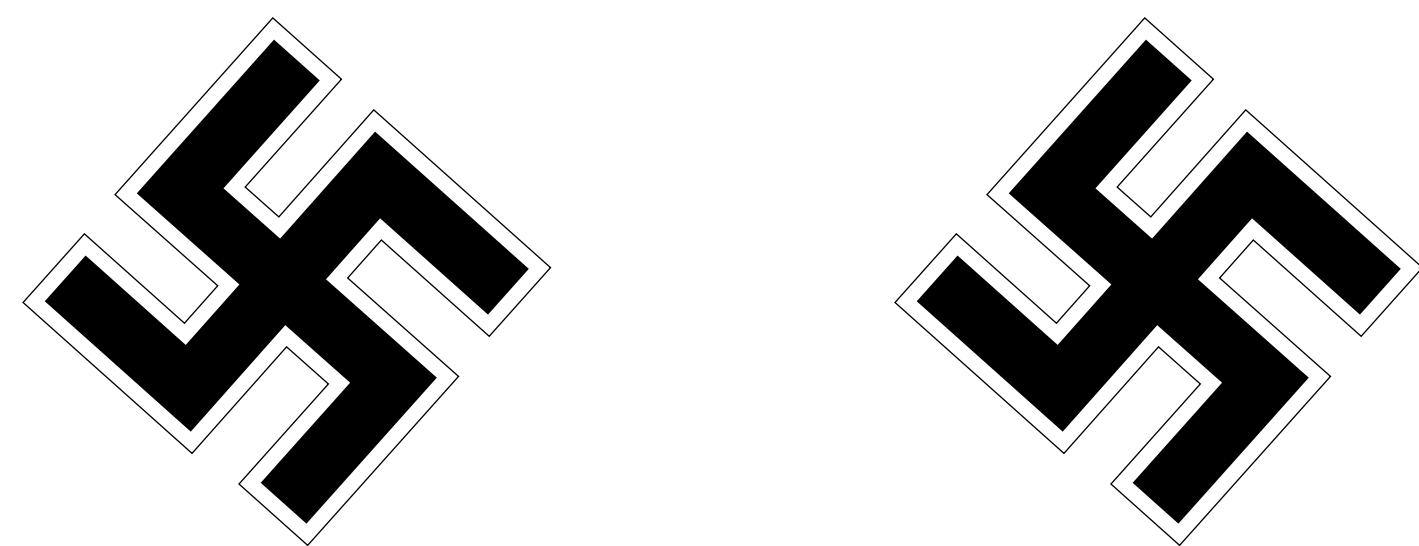
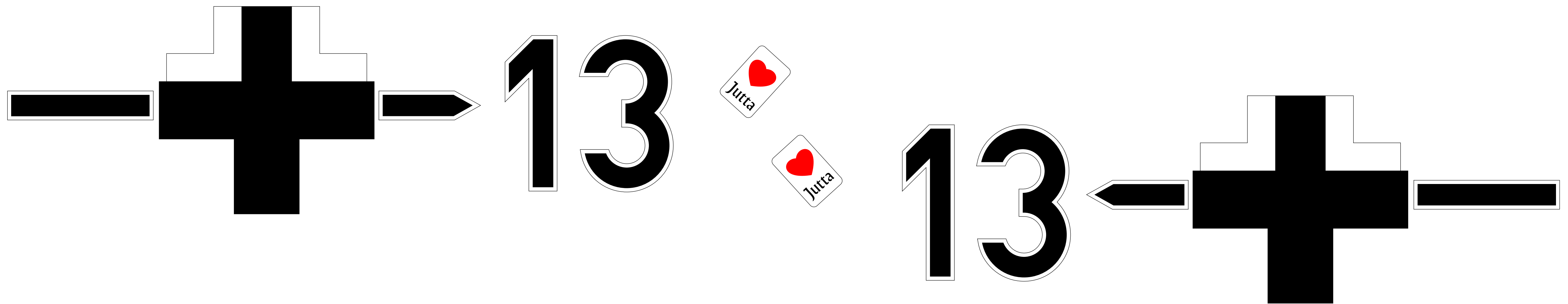
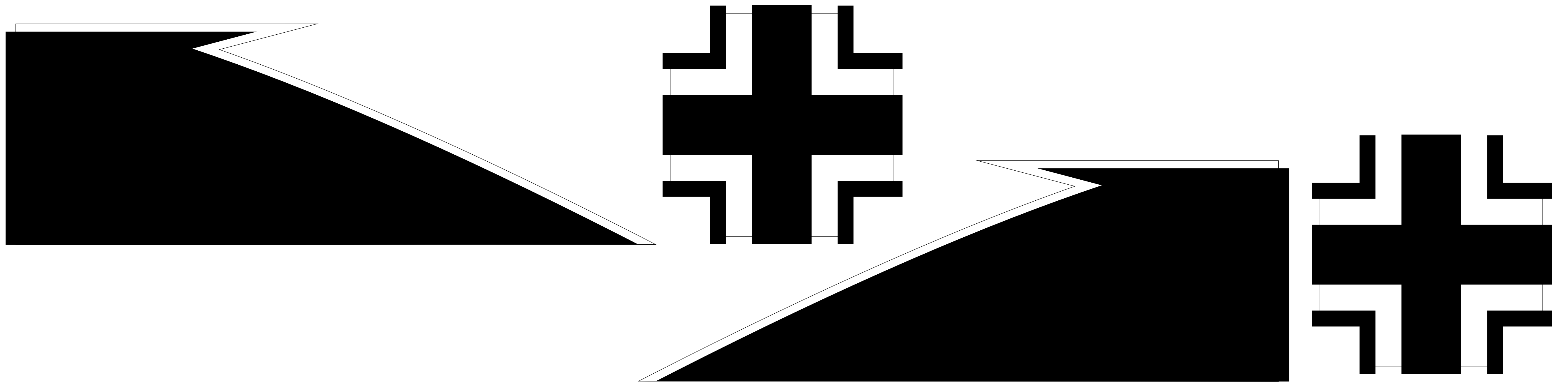

You can use these for making the design on your plane or you can use the vector files for your vinyl cutter.