

300 mm

300 mm

Don't peel paper in this area

P

steel paper in this area

300 mm

300 mm



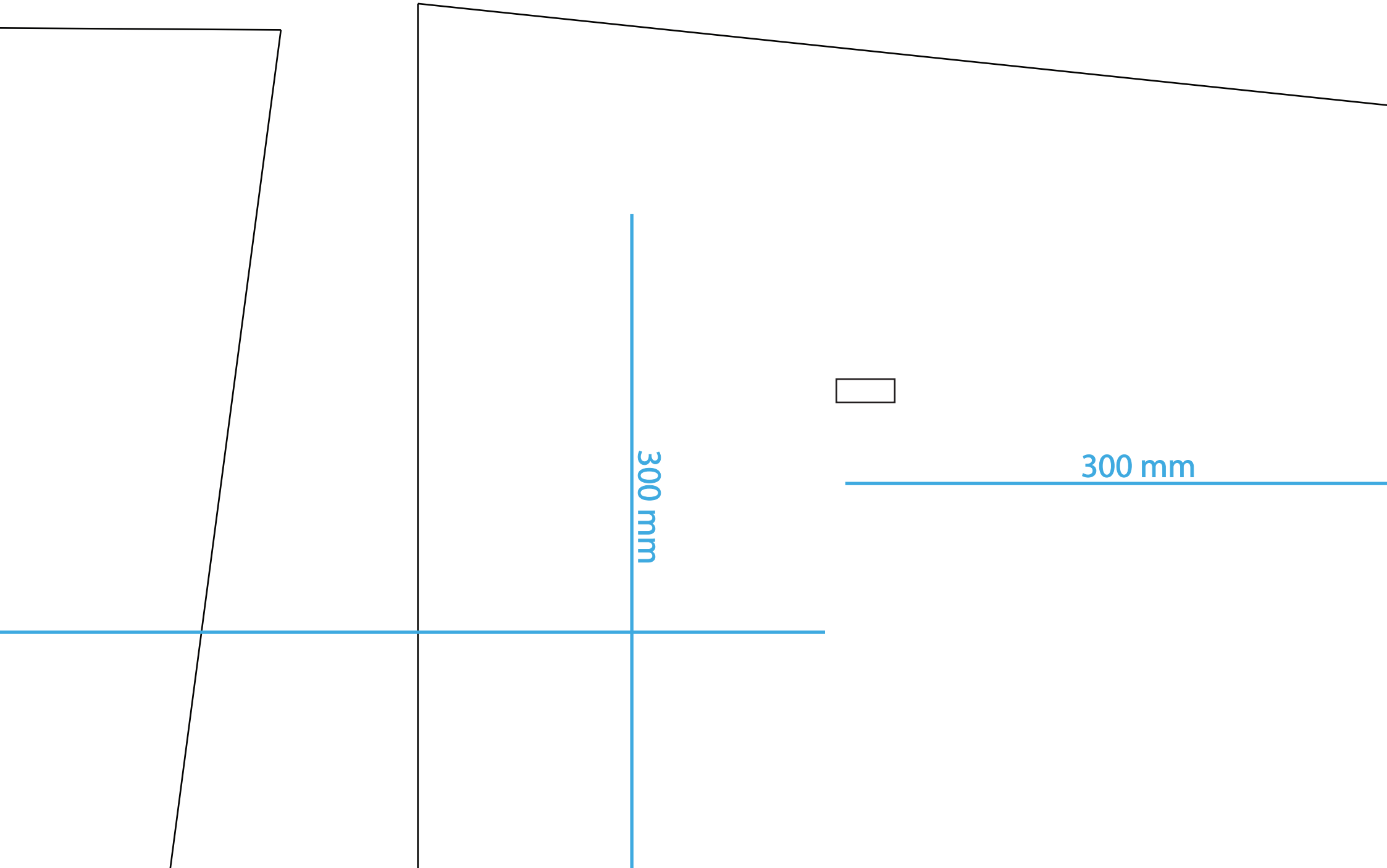

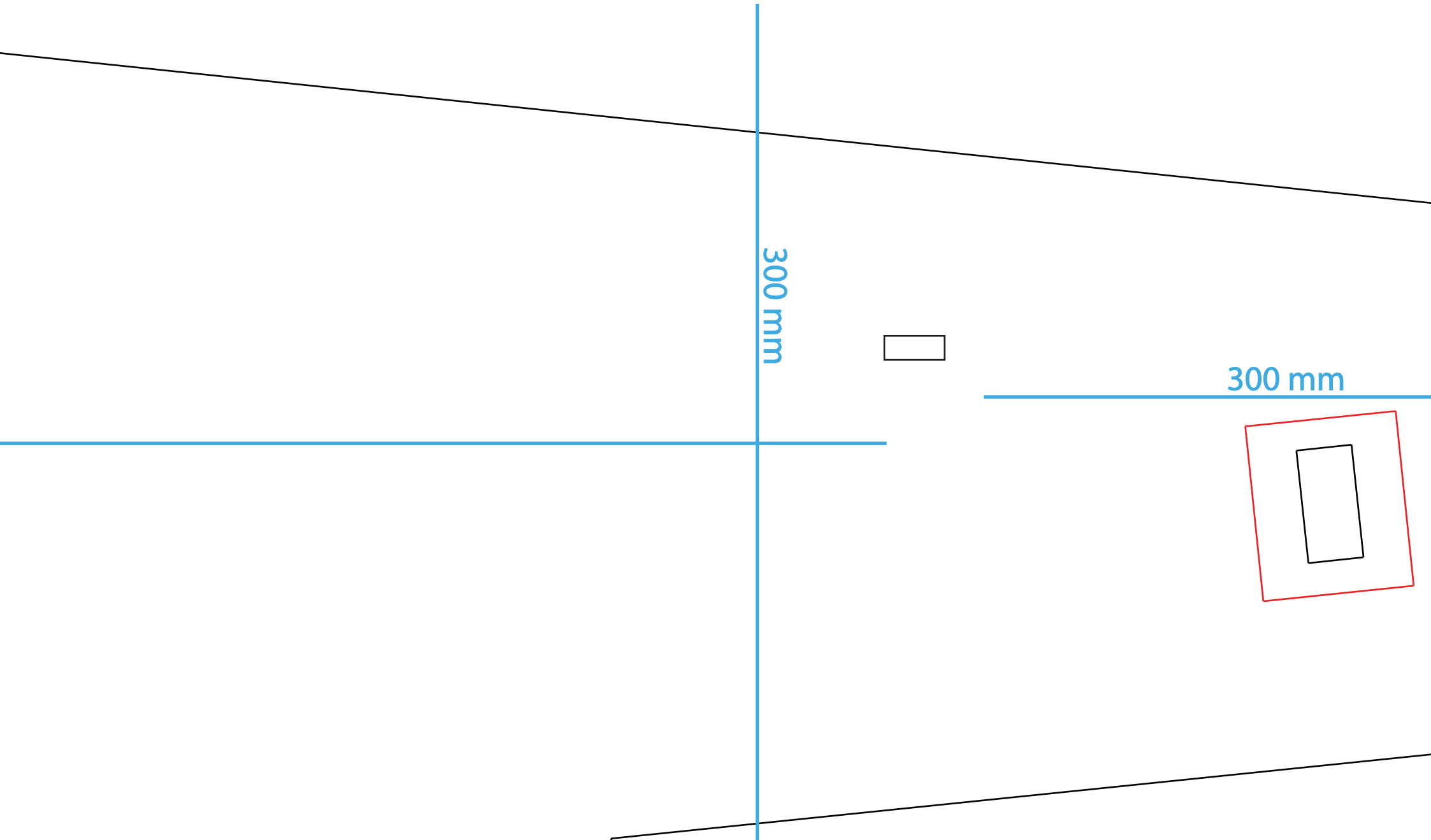

300 mm

300 mm

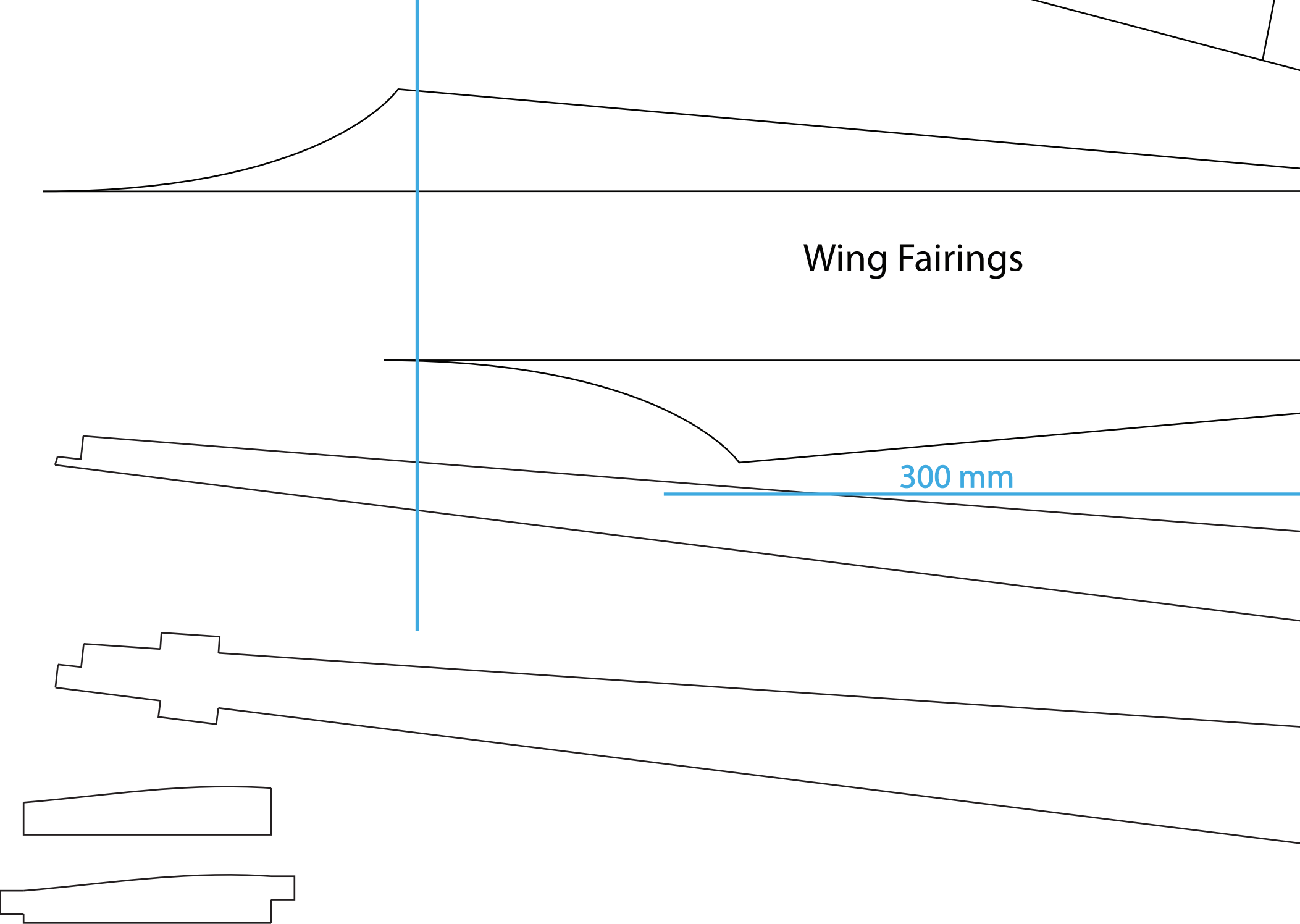

*Don't peel paper in this area*

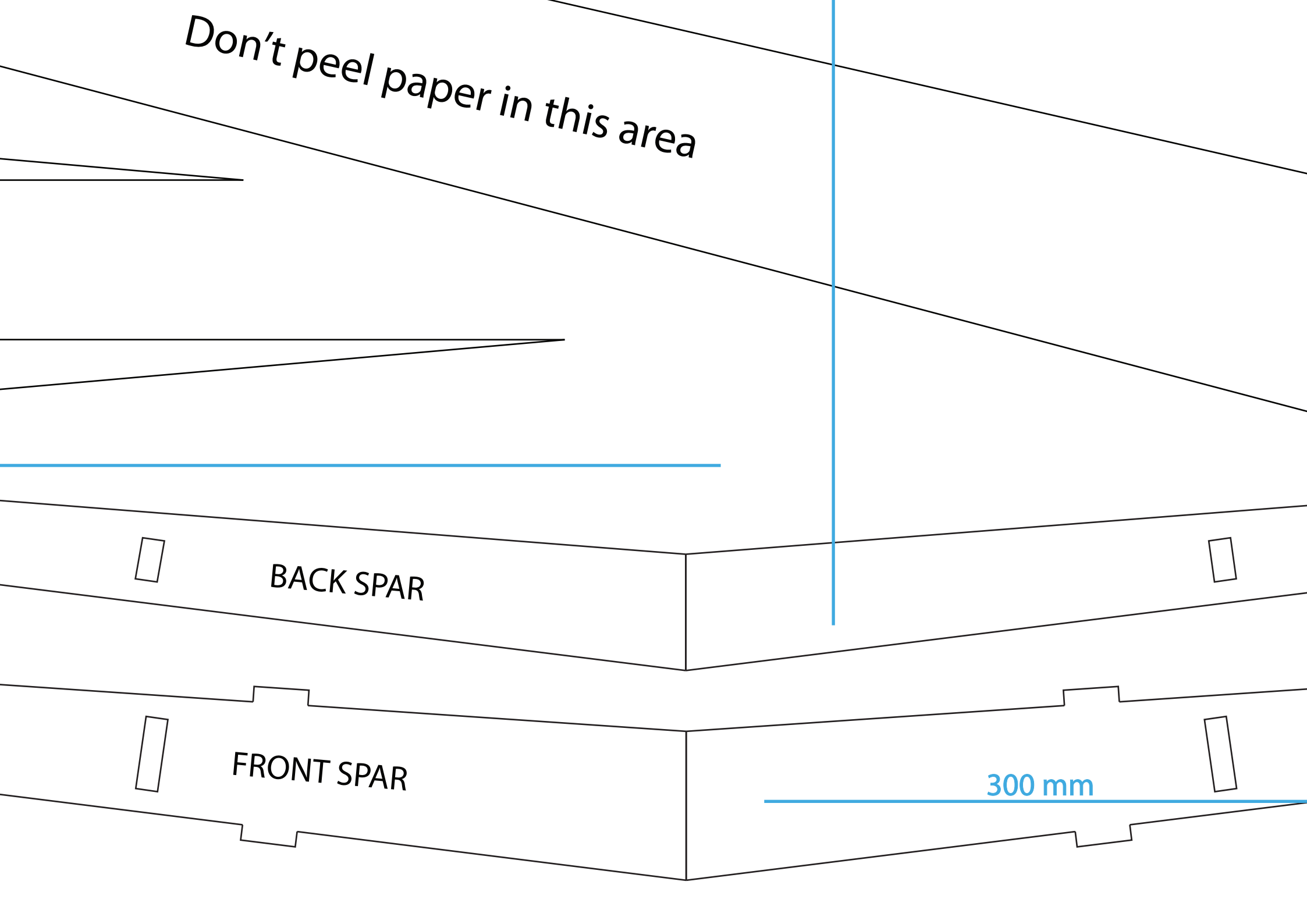

BACK SPAR

FRONT SPAR

300 mm

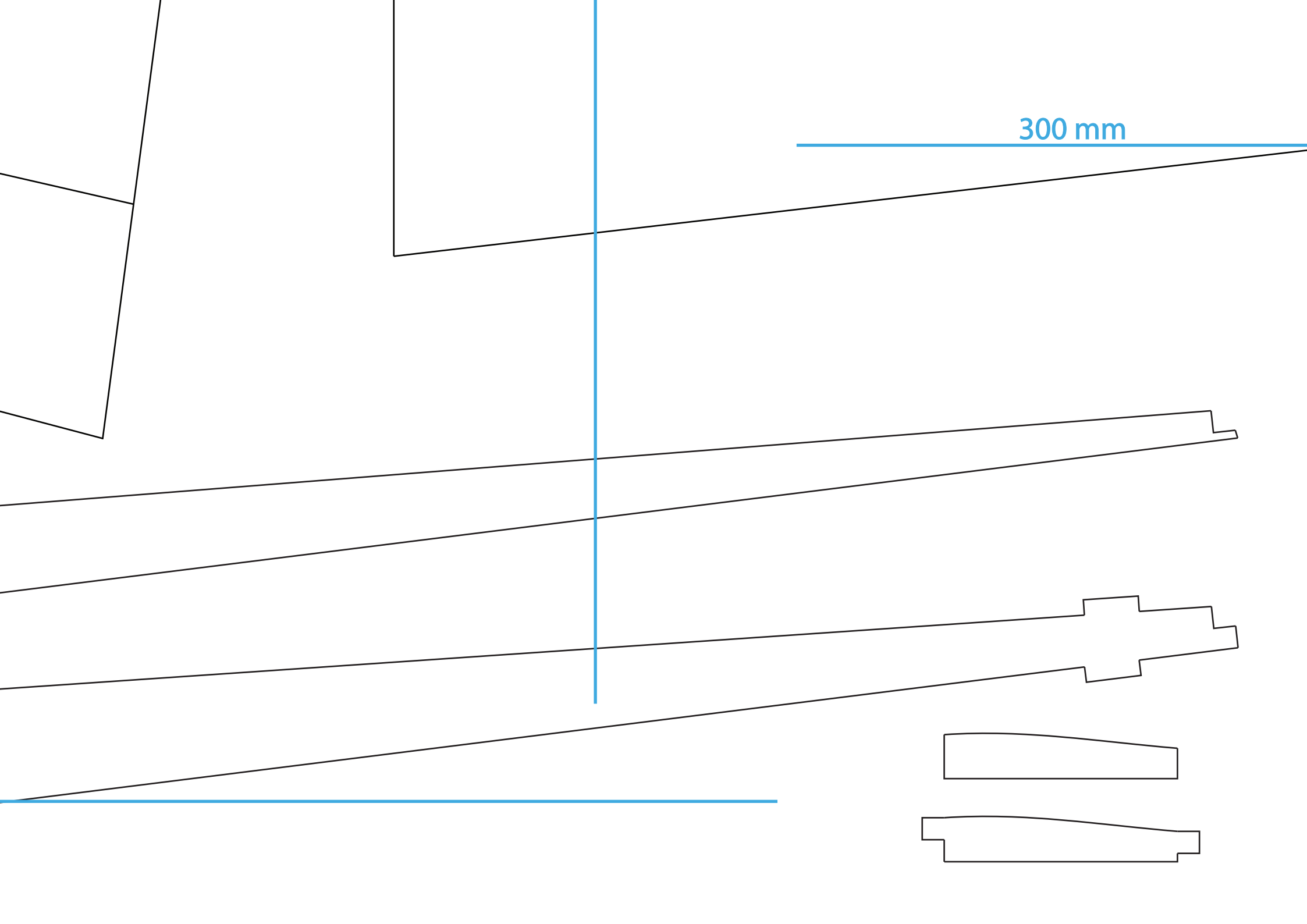

300 mm

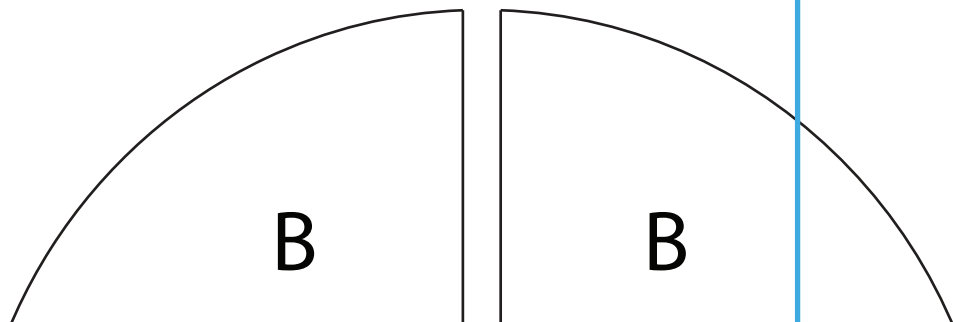
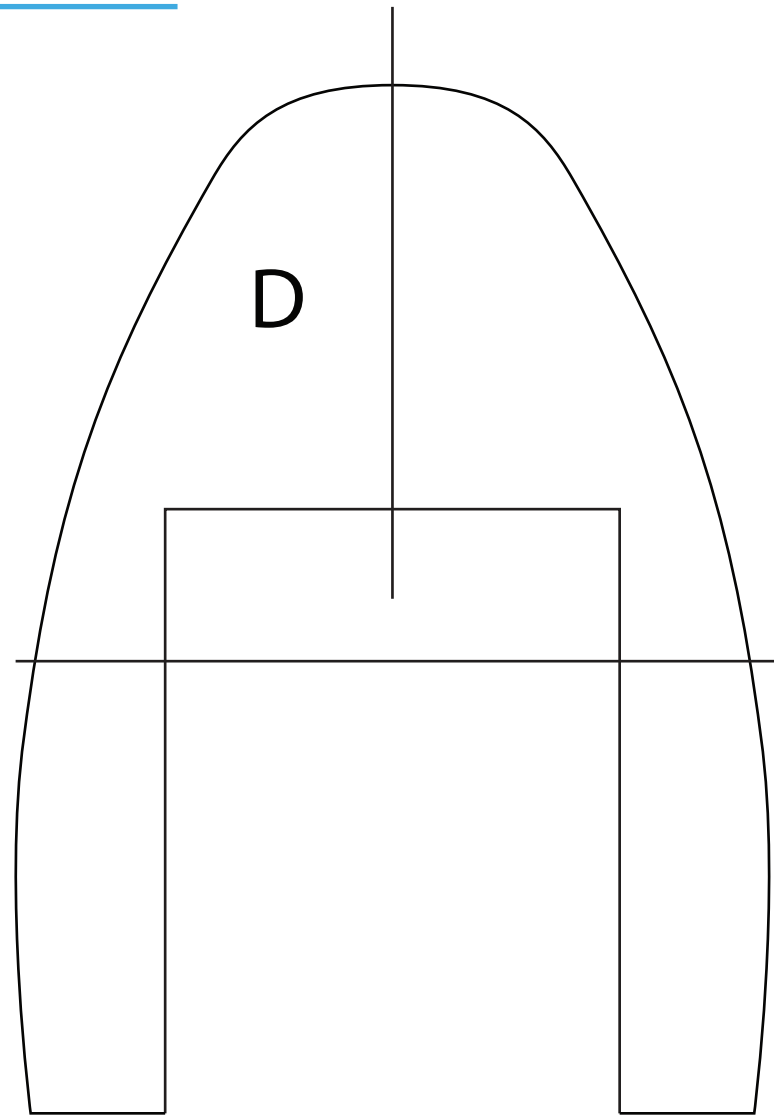
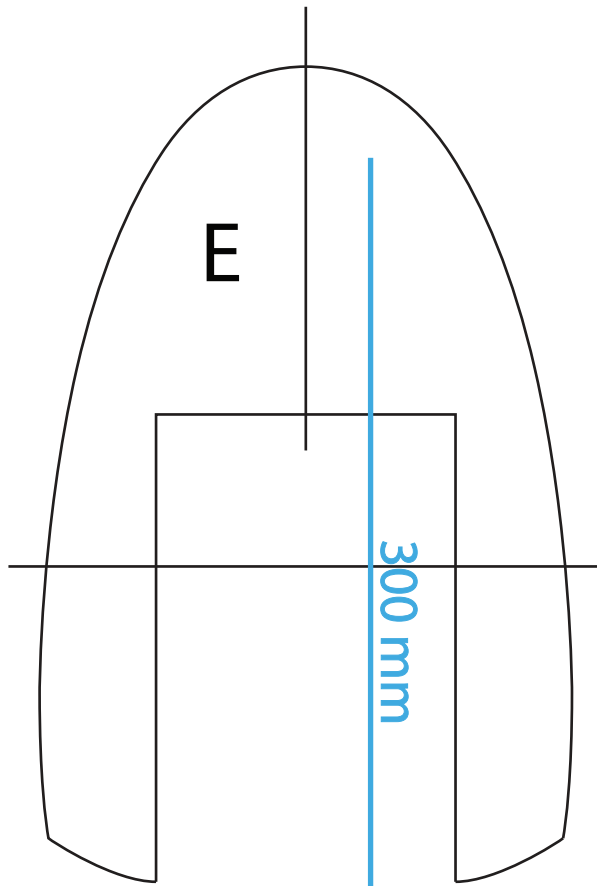
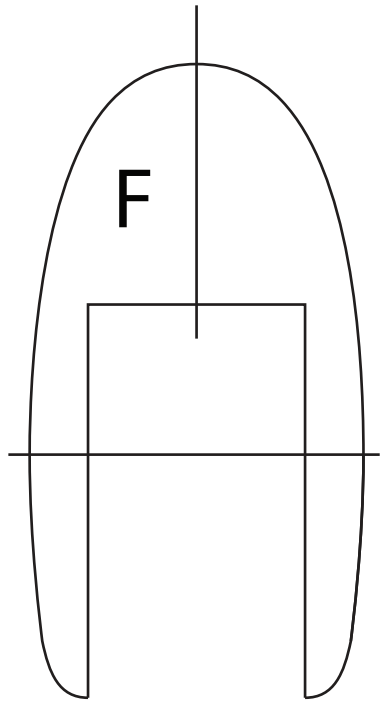
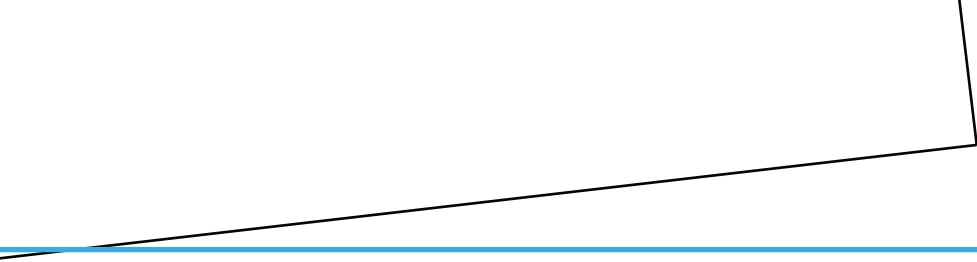



These pieces are made from hobby plywood.

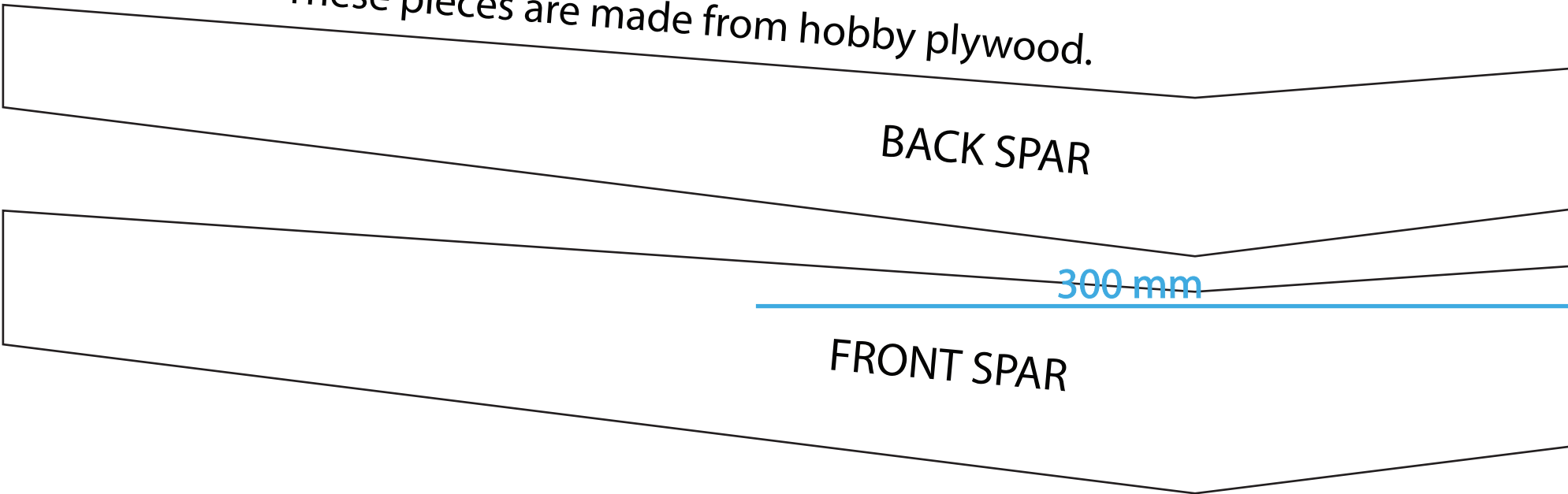

The Power Pod is the new Flite Test FT Corsair Power Pack

300 mm

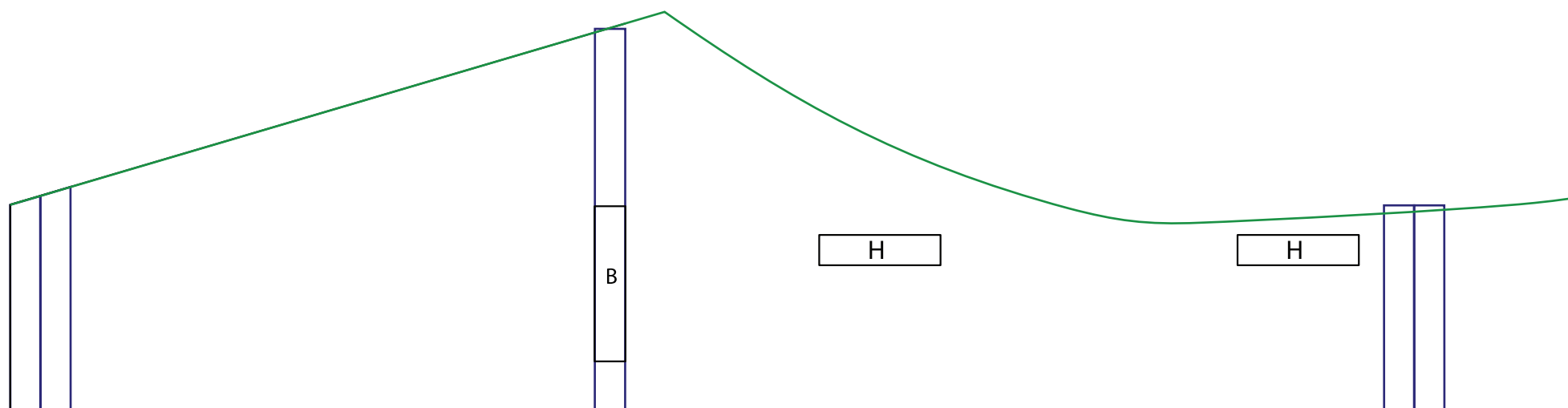

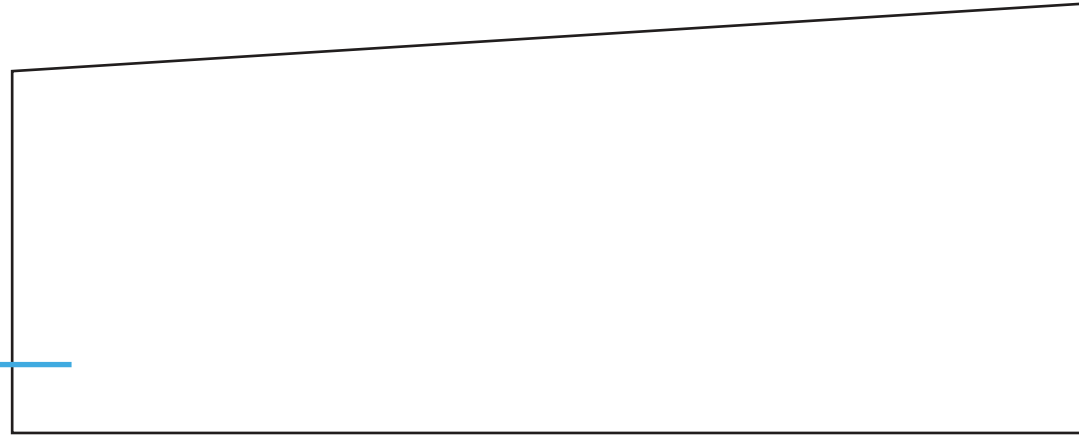
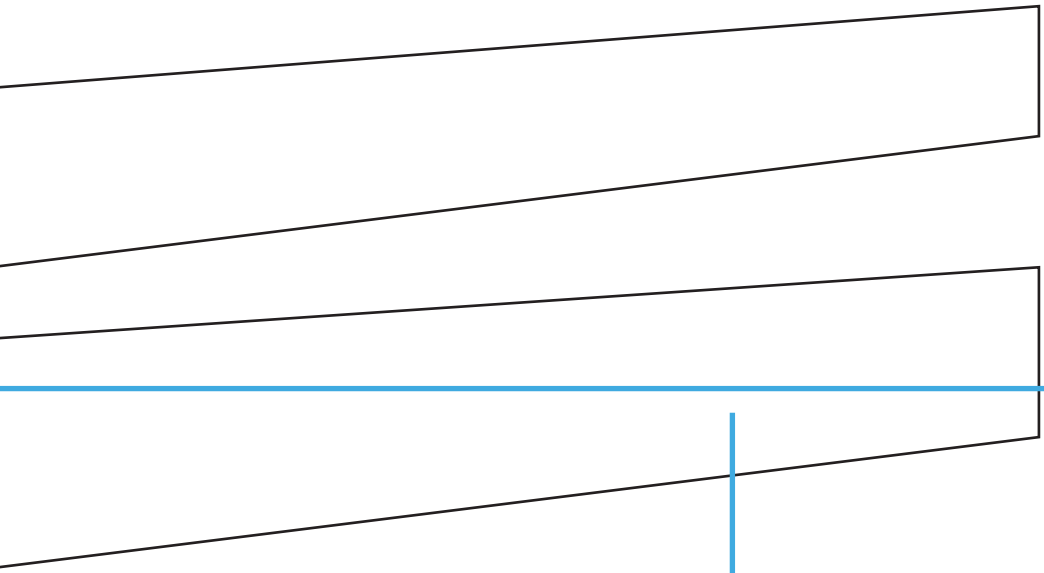

This piece is for the hatch.

K

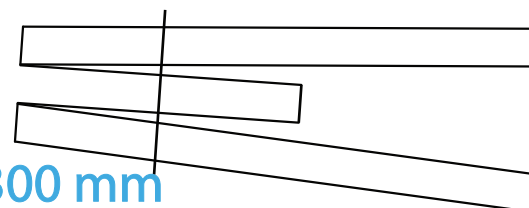
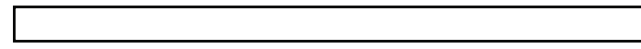

300 mm

300 mm

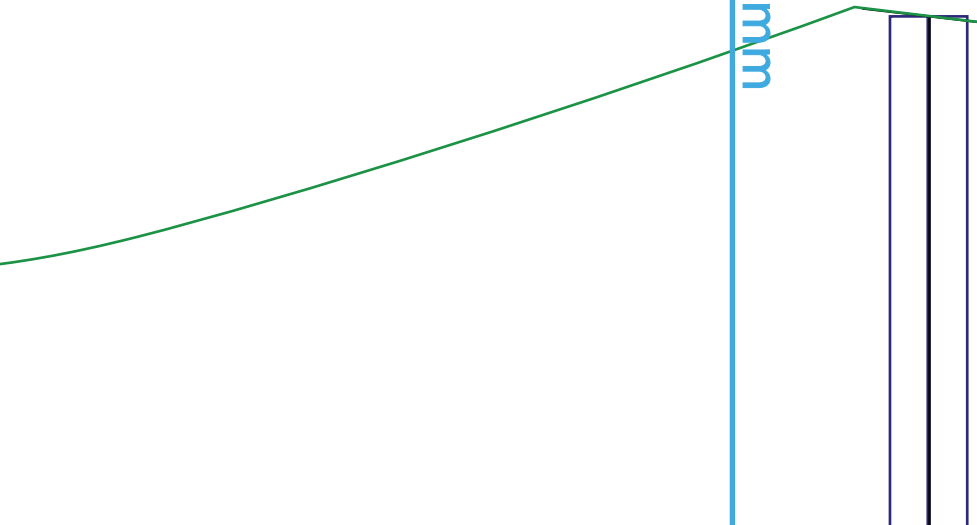
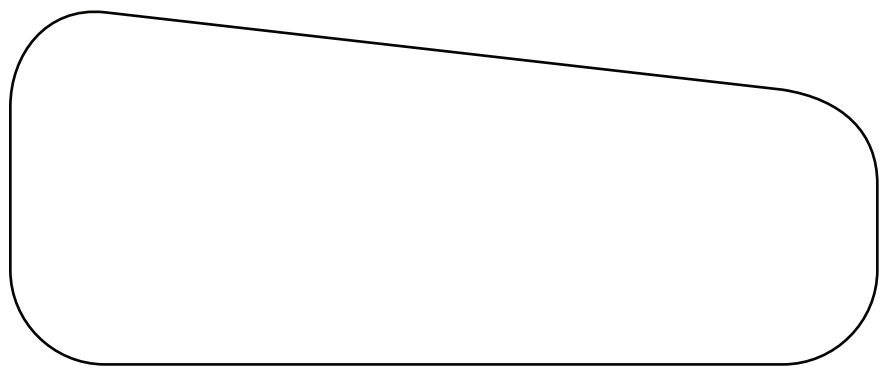

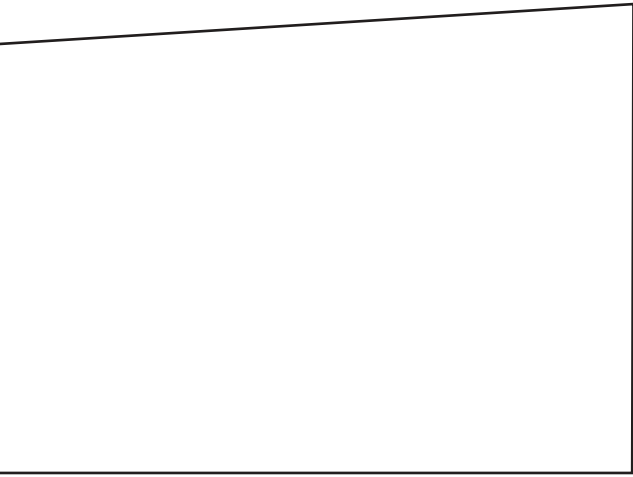

This piece goes on the bottom of the fuselage behind the wing and to the rudder

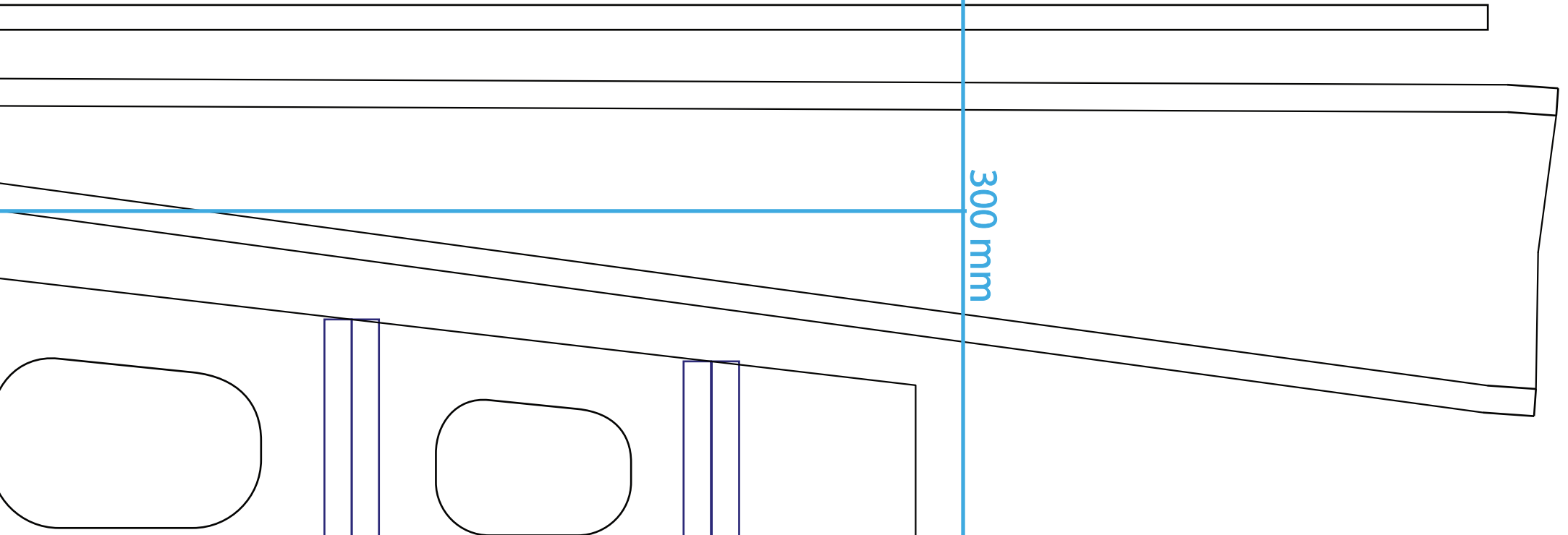

300 mm

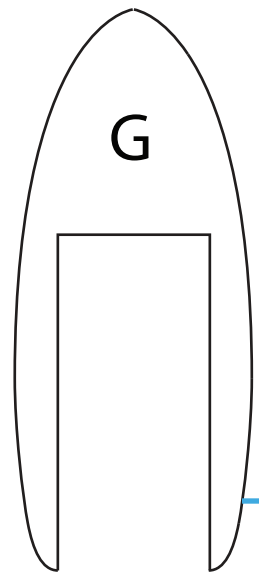
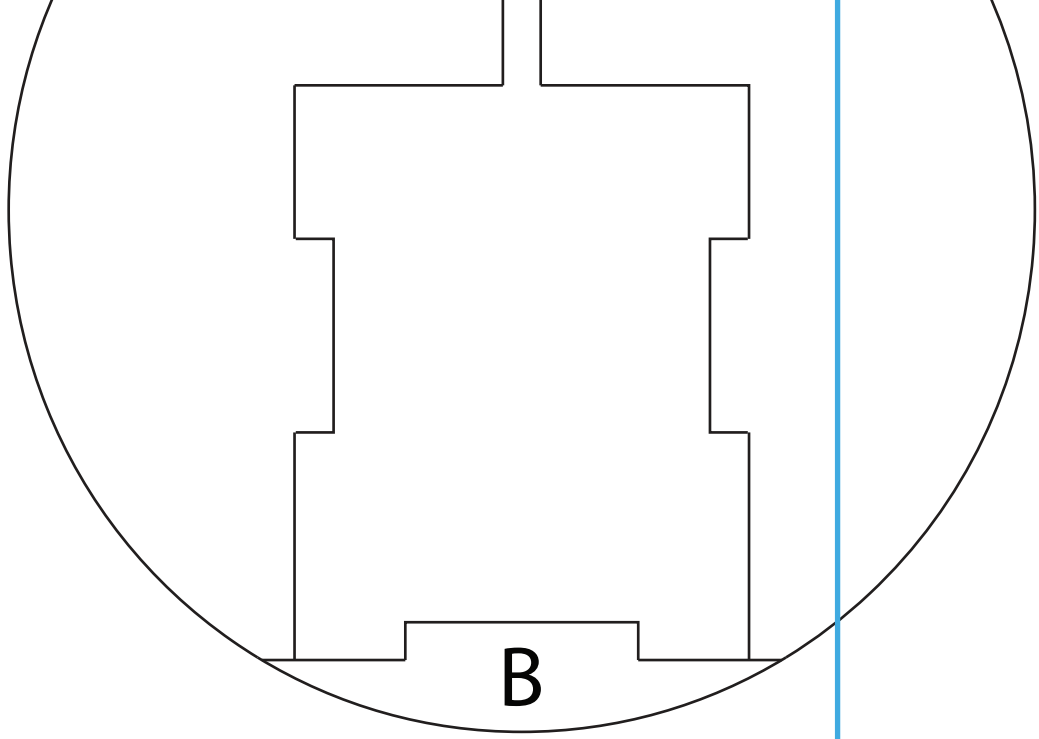

300 mm

300 mm

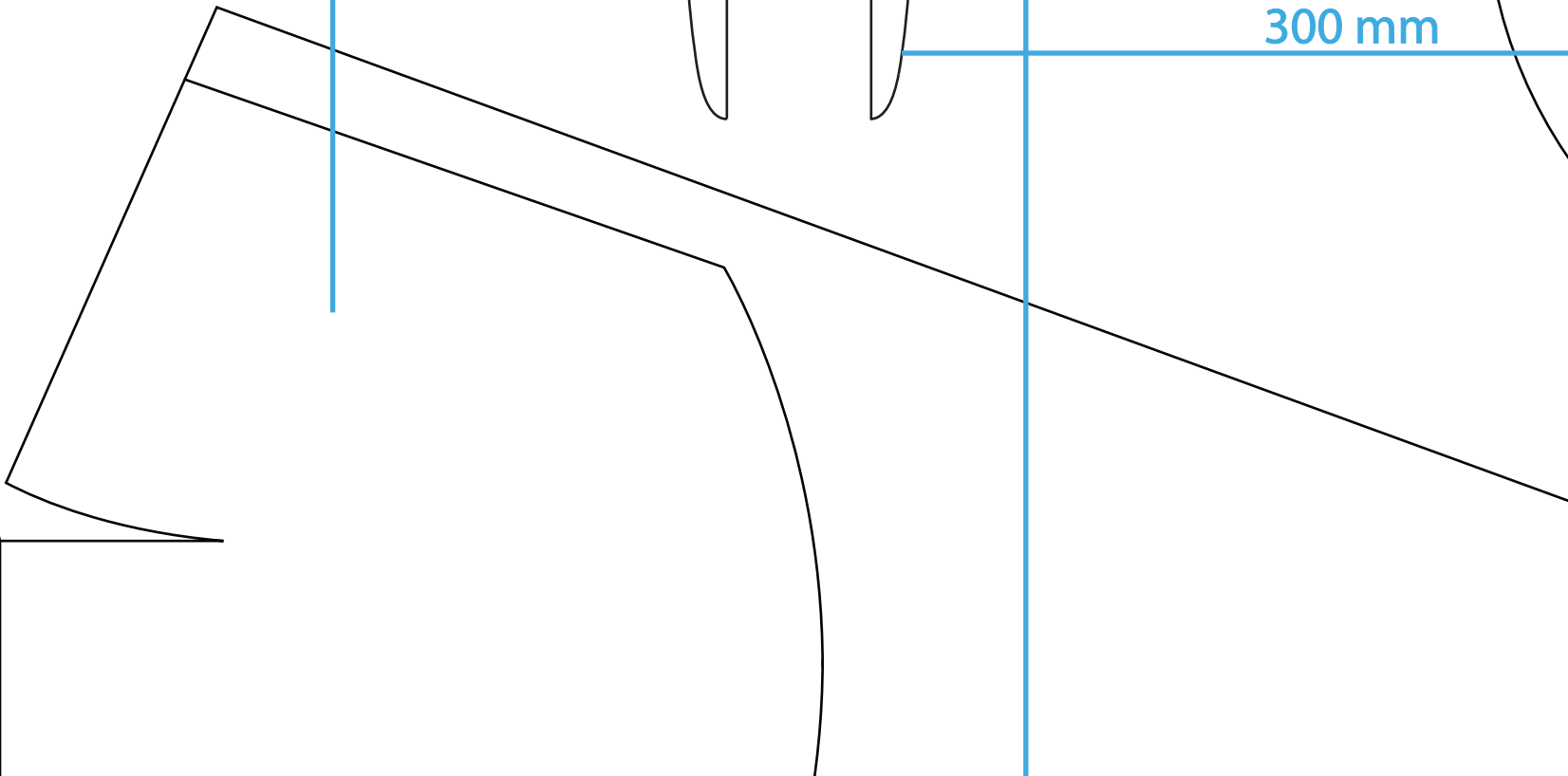
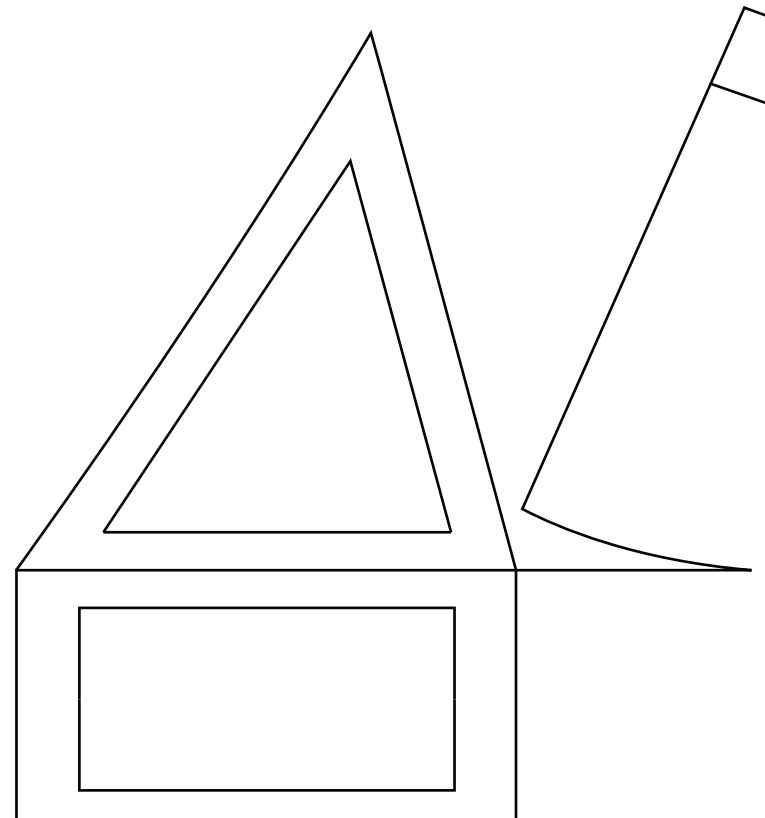

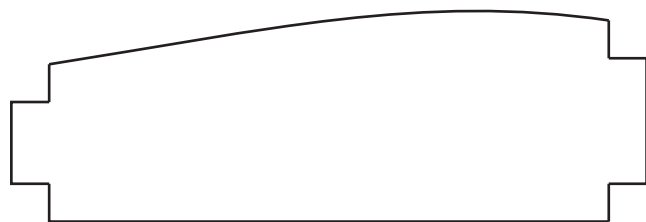
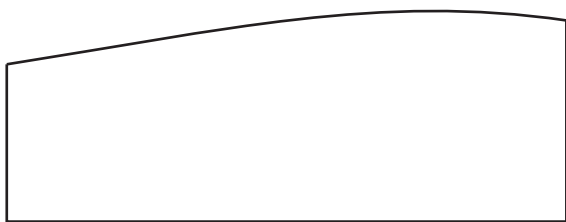
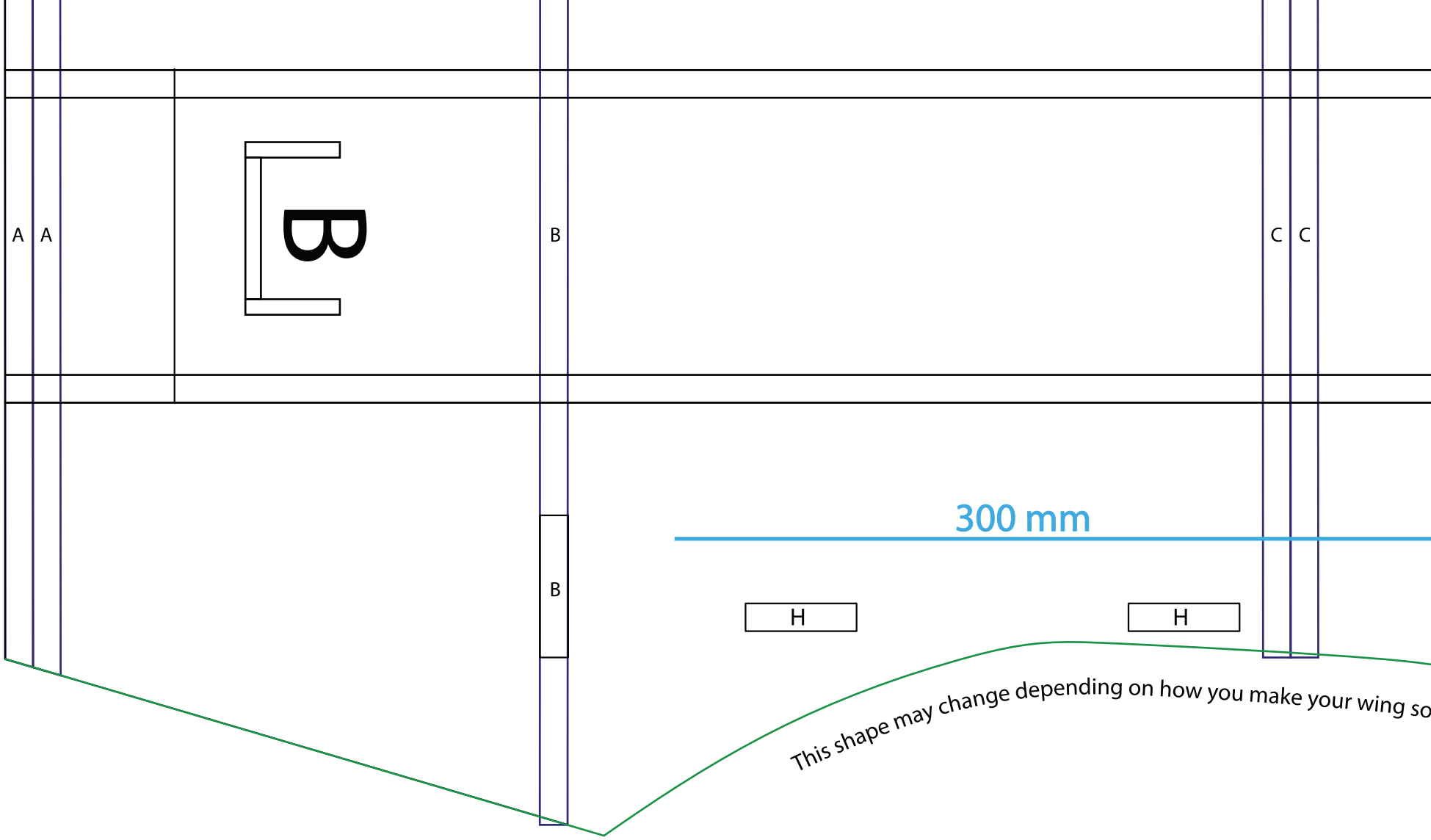

give yourself some more space to work with.

D D

E E

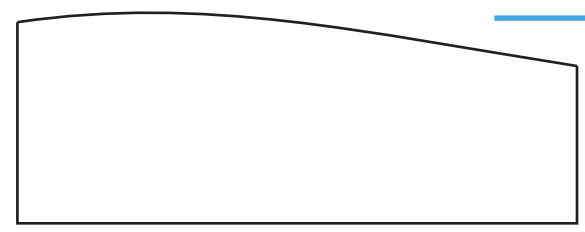
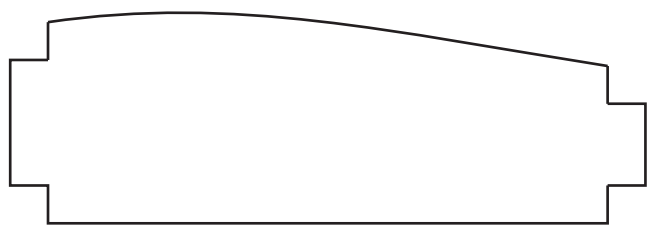
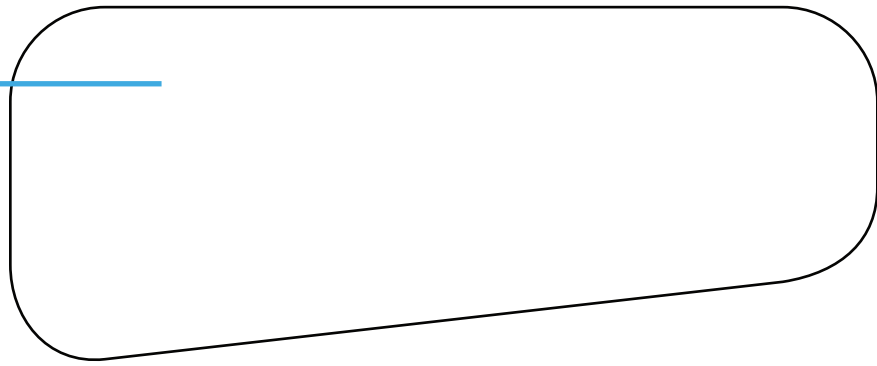
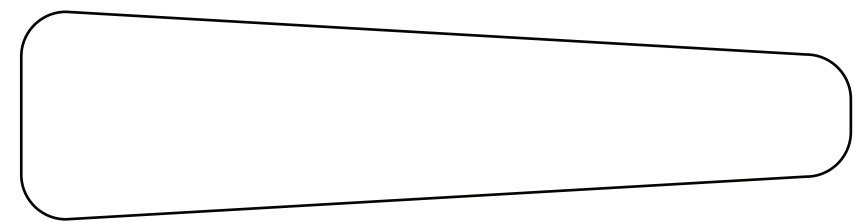
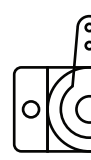

300 mm



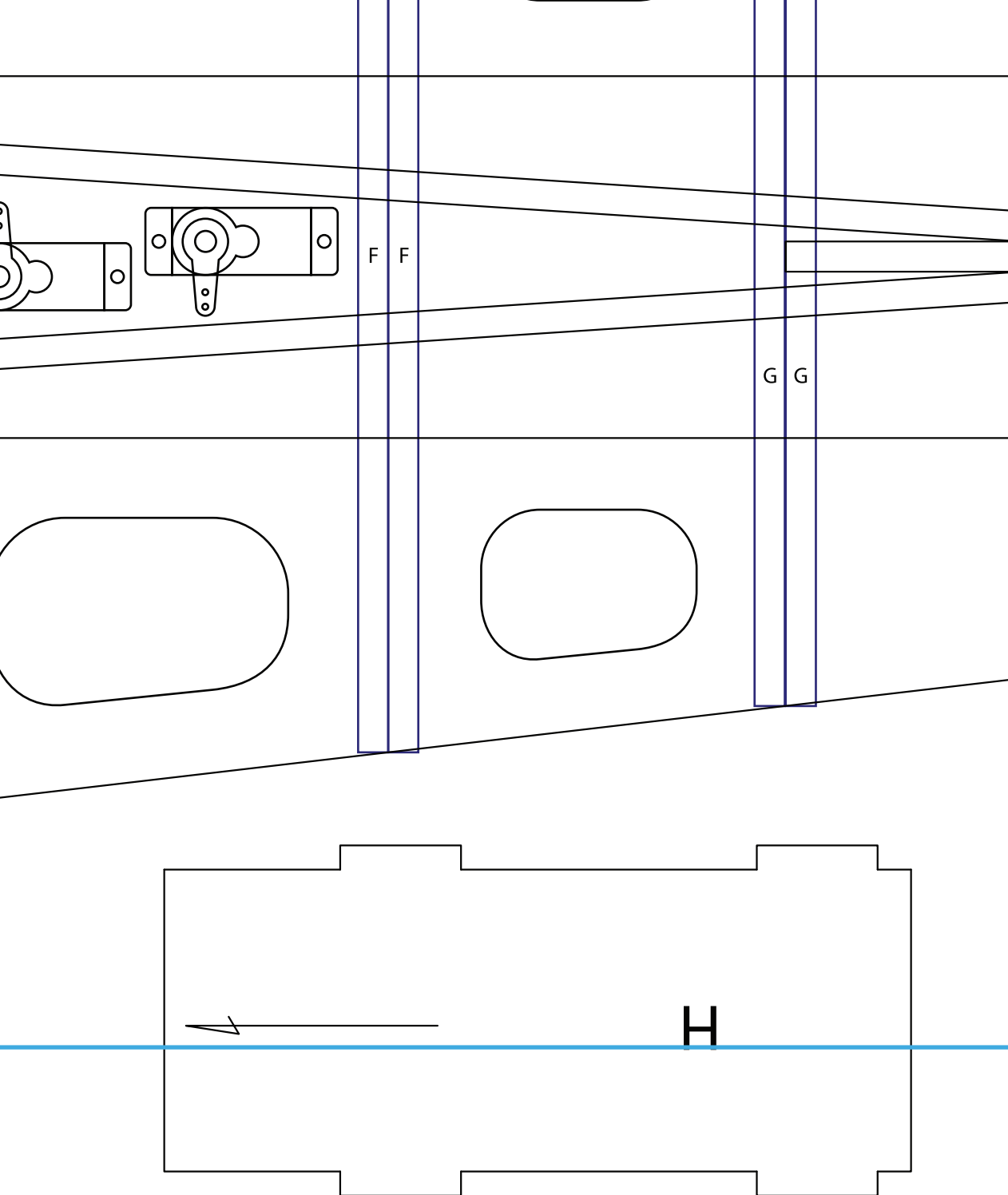

This piece goes on the bottom of the fuselage in the front, on the angle.

B

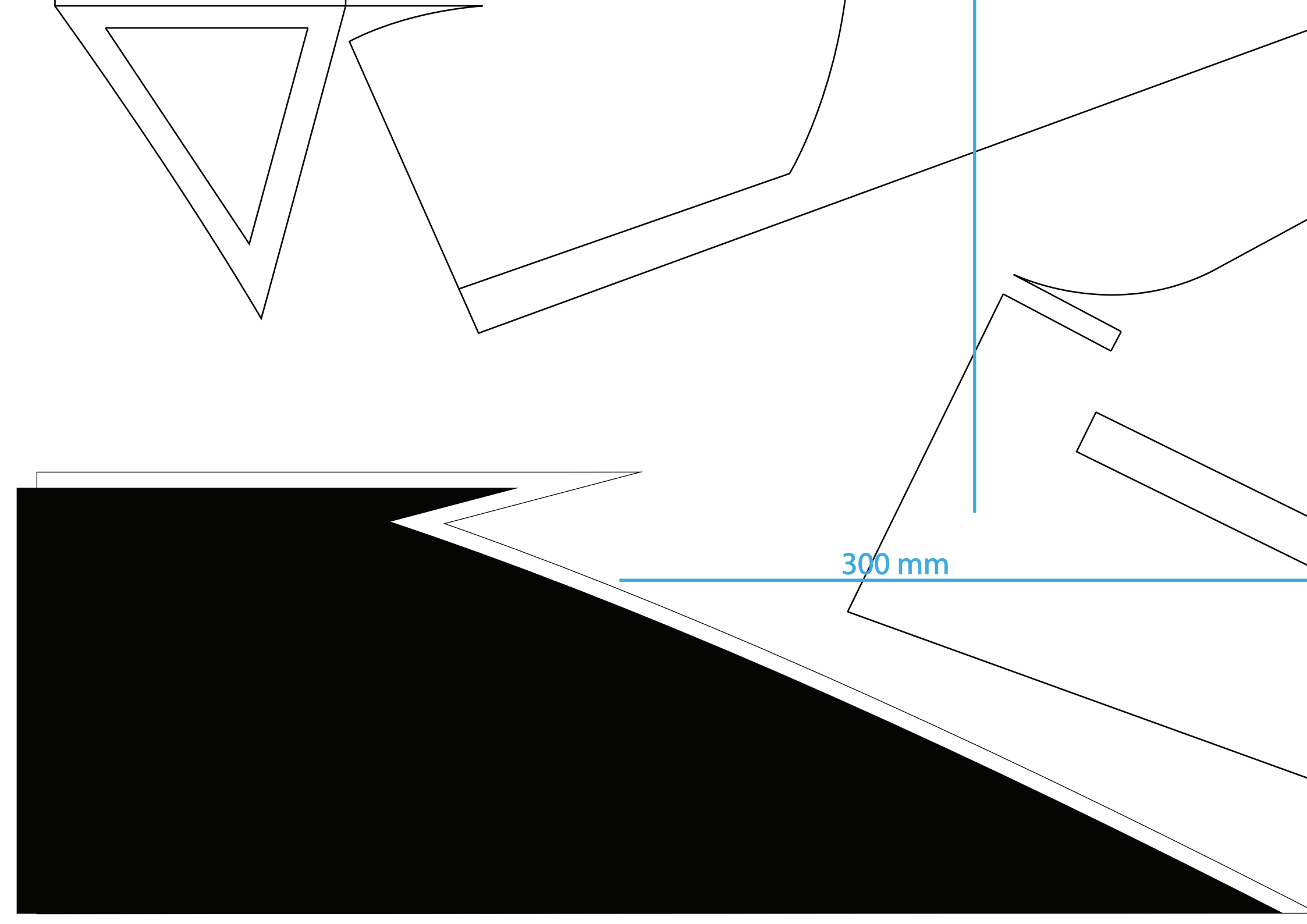

300 mm



You might want to cut the  
"longer" for any a

300 mm

300 mm

**A**

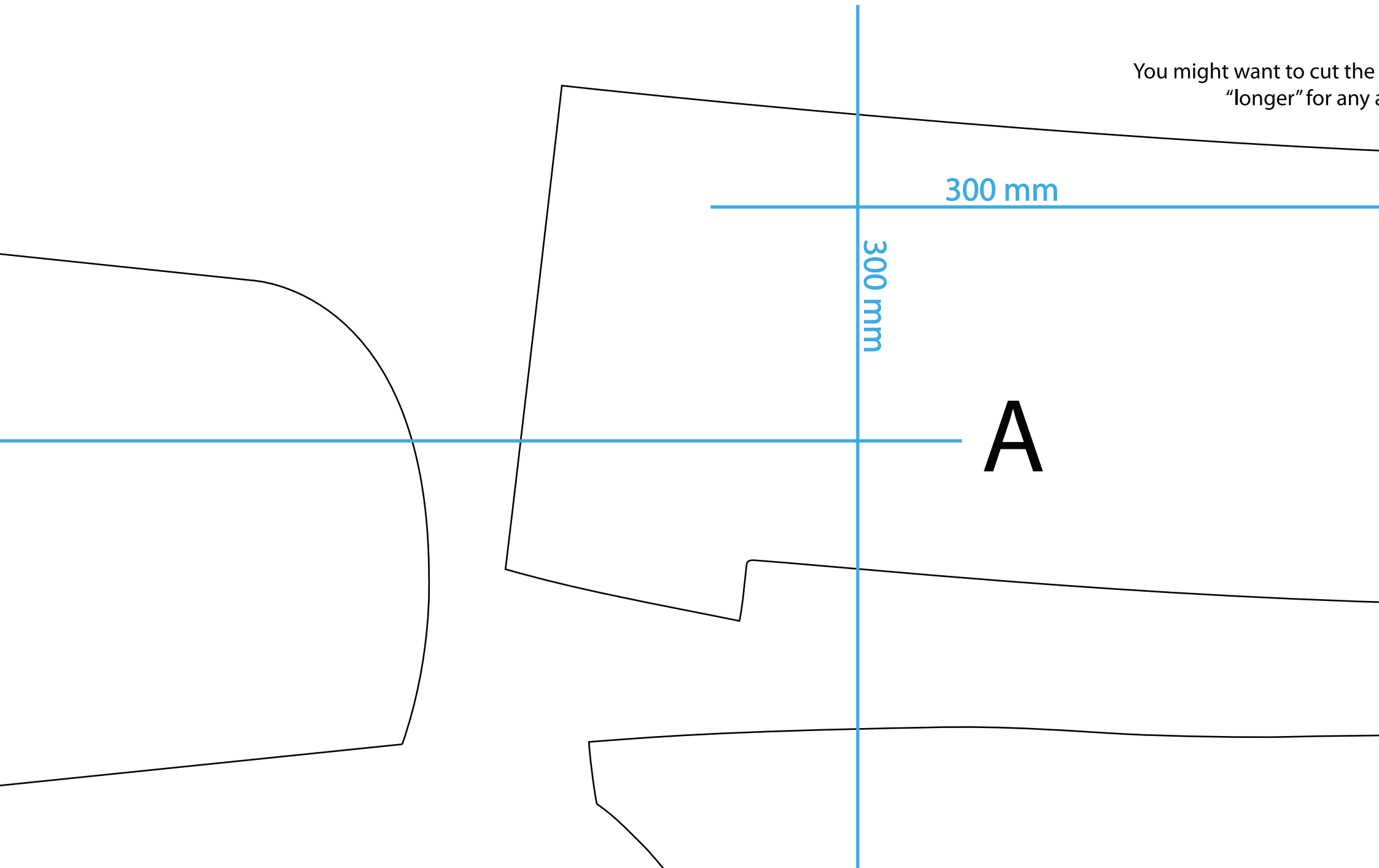

length of the fuselage covering pieces a little  
adjustments that might be needed.

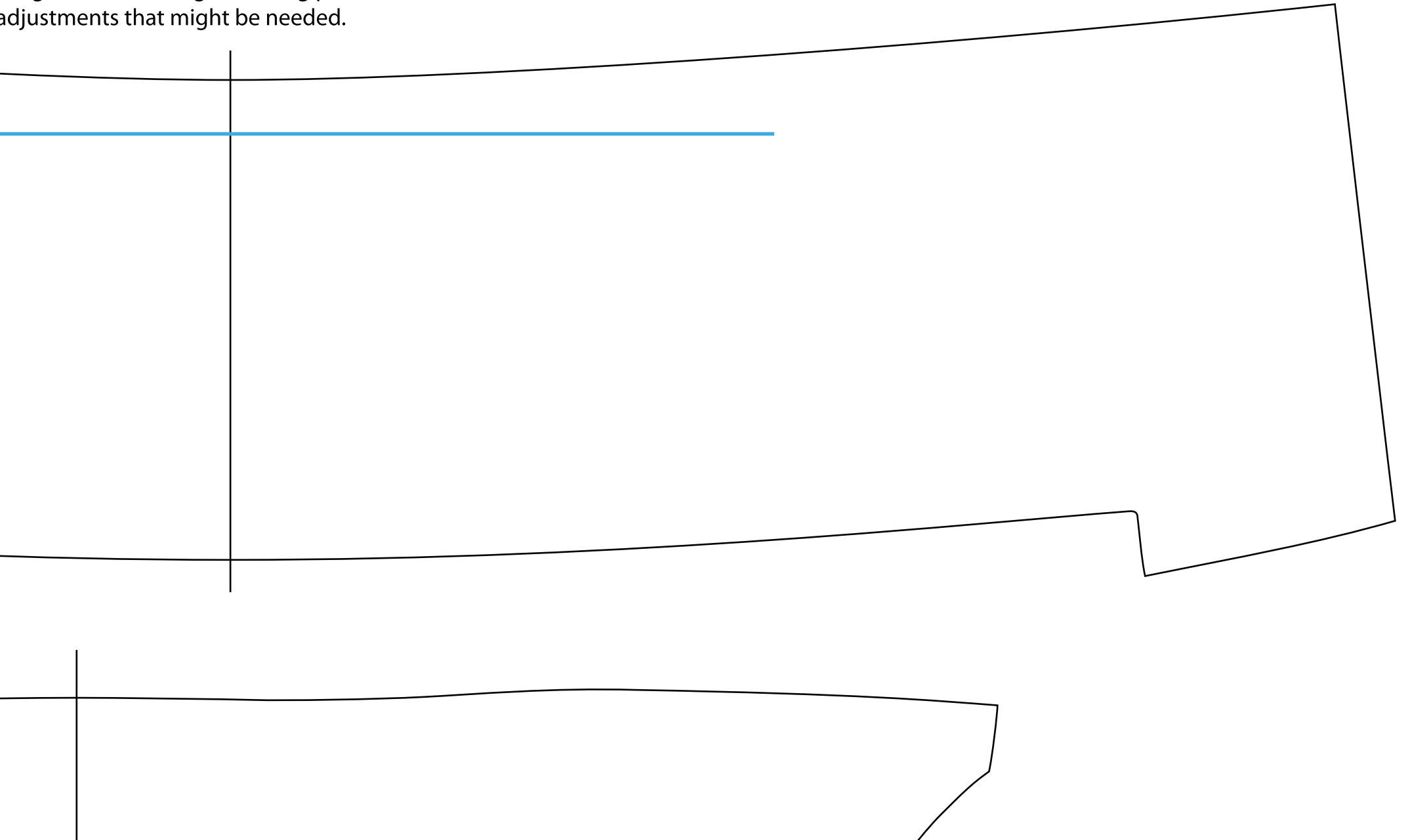

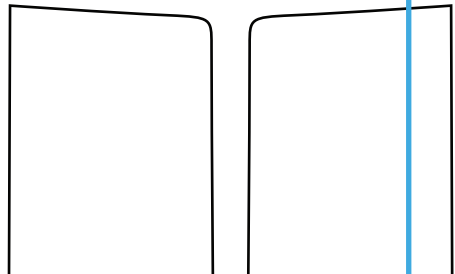

300 mm

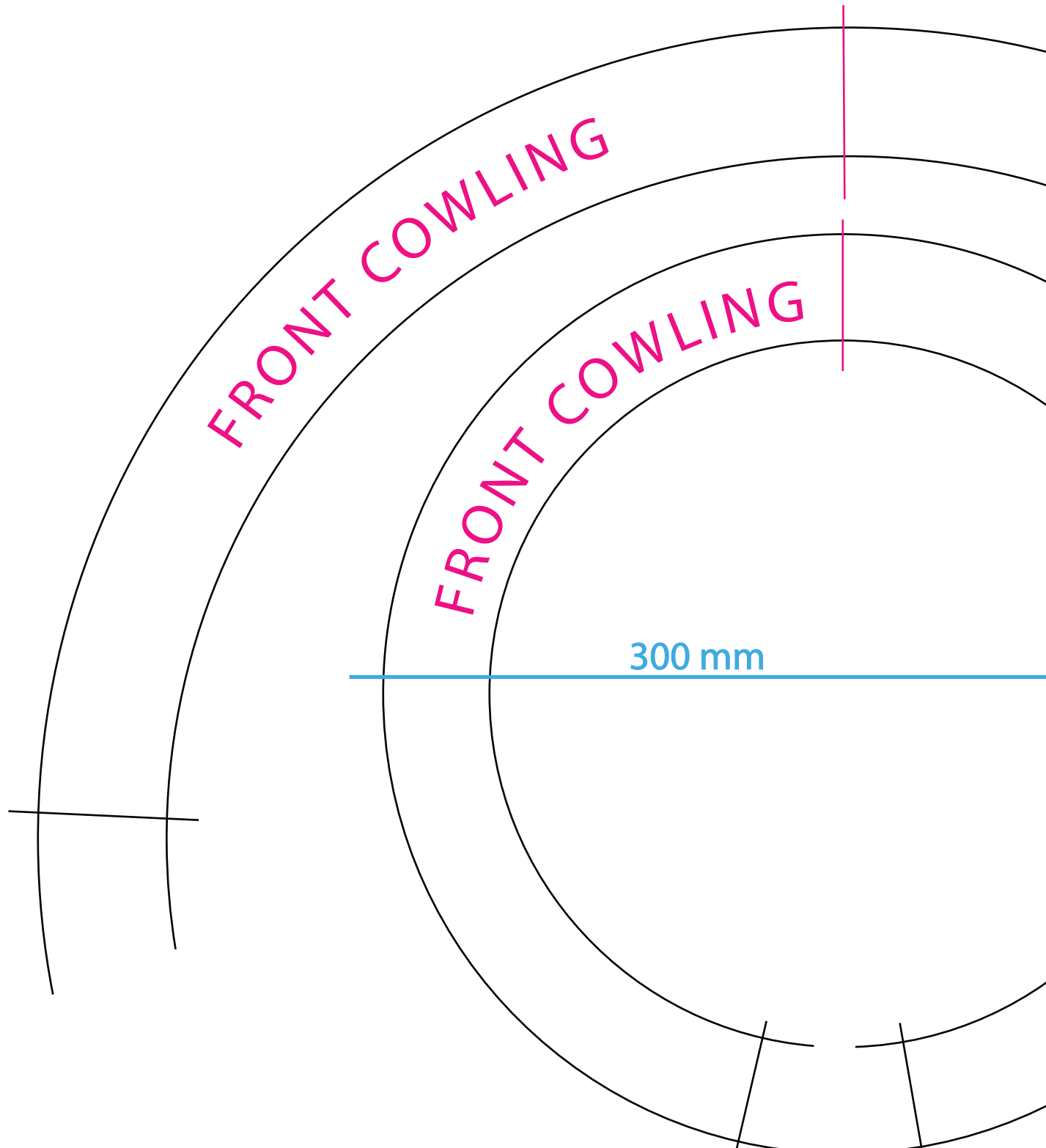

FRONT COWLING

FRONT COWLING

300 mm

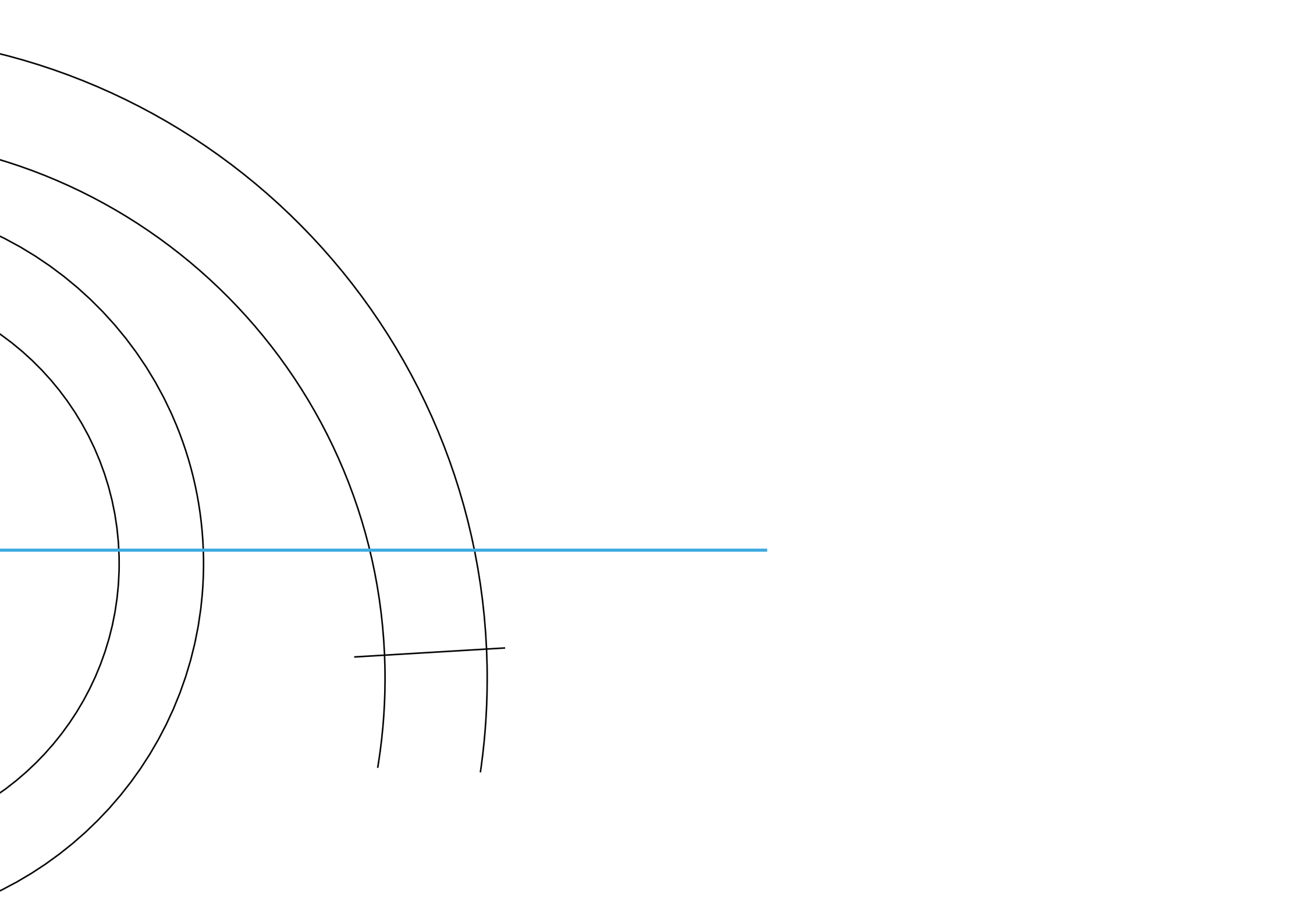

B

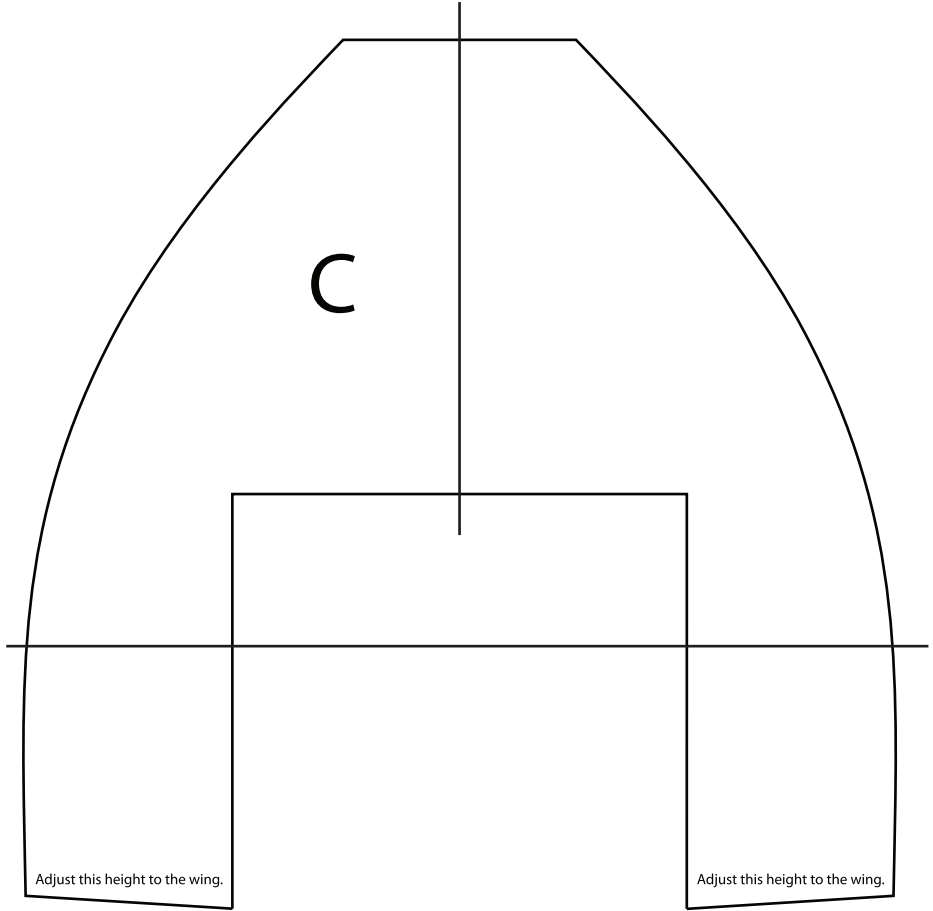

300 mm

300 mm

C

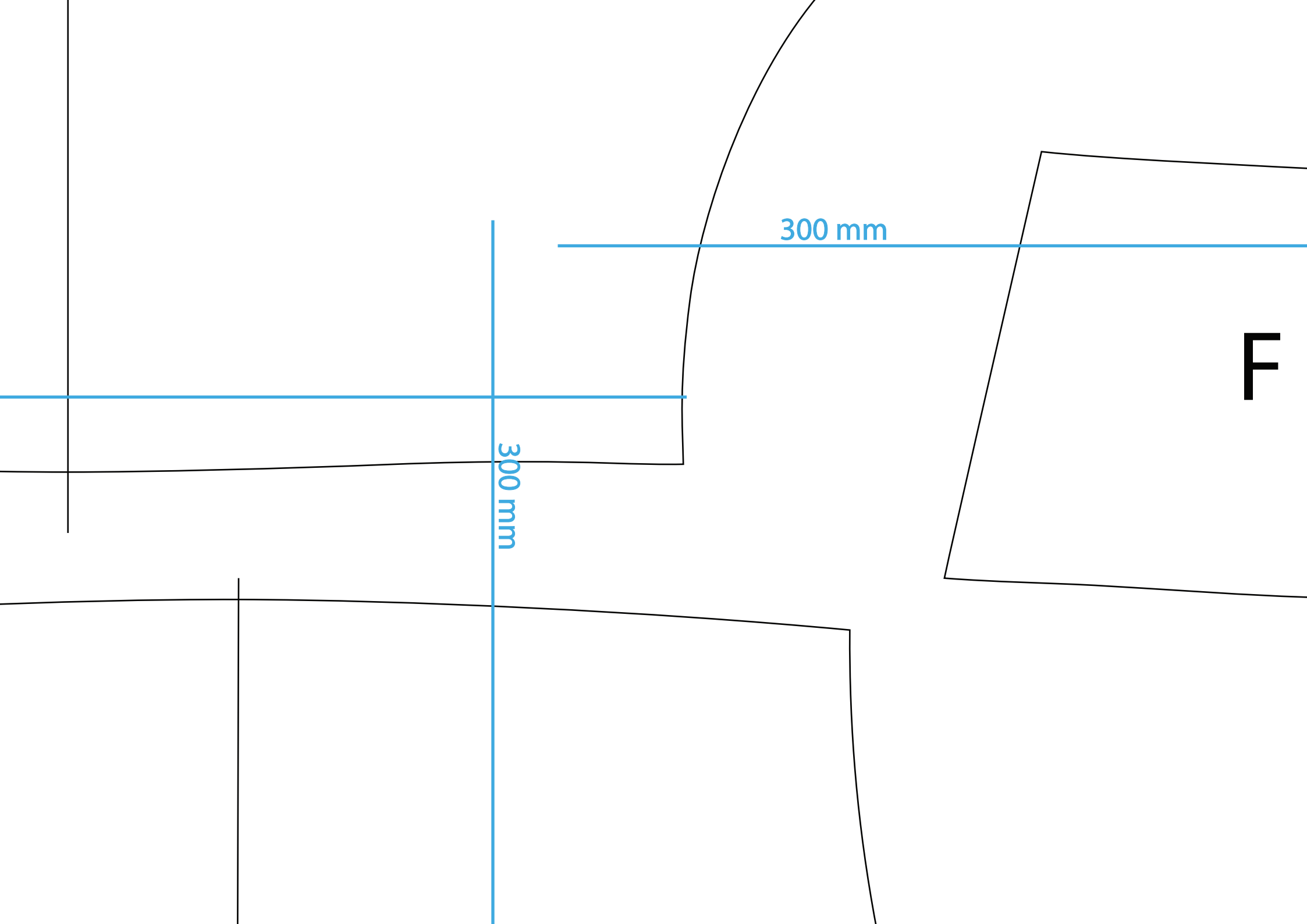

300 mm

300 mm

F

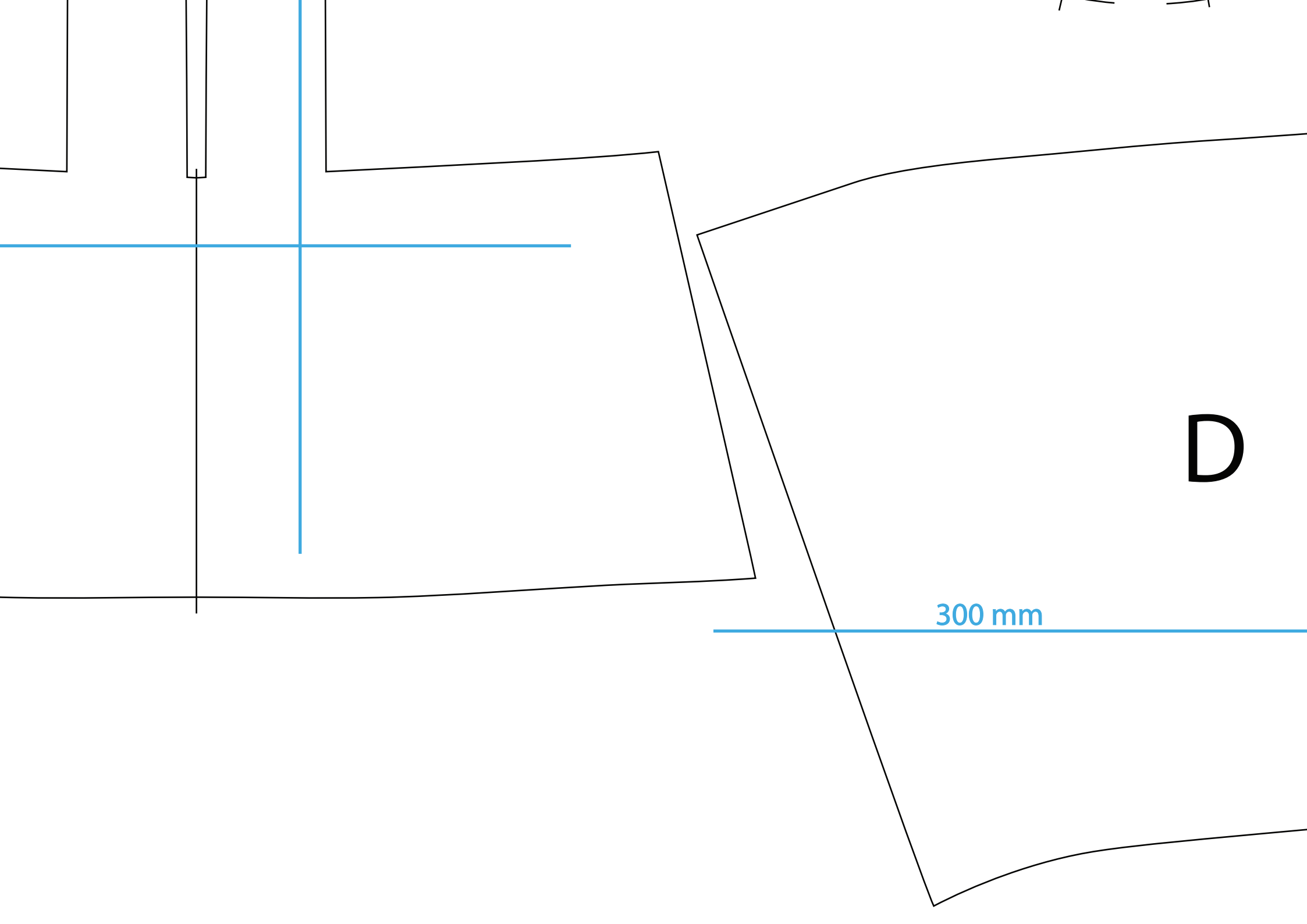

300 mm

D

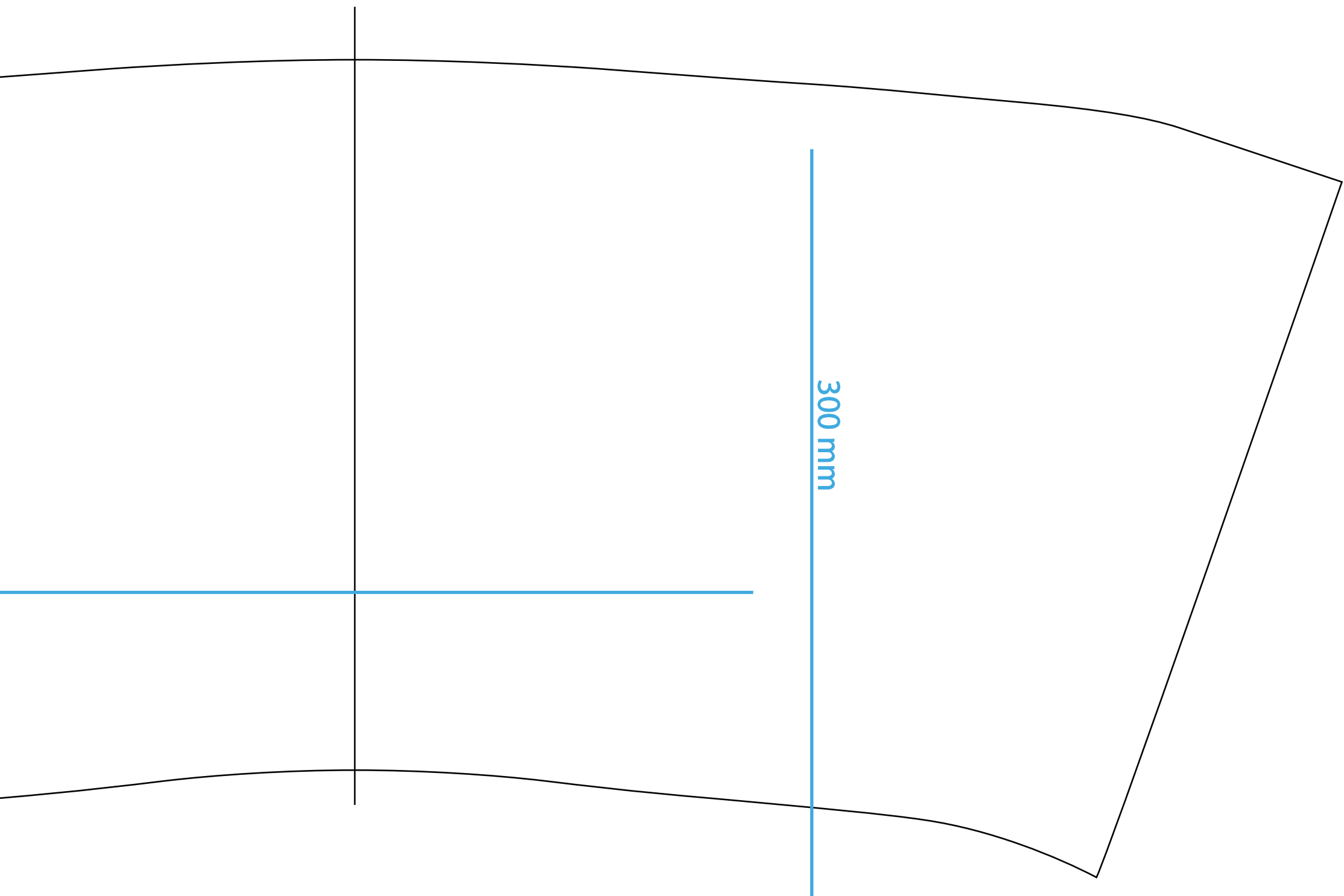



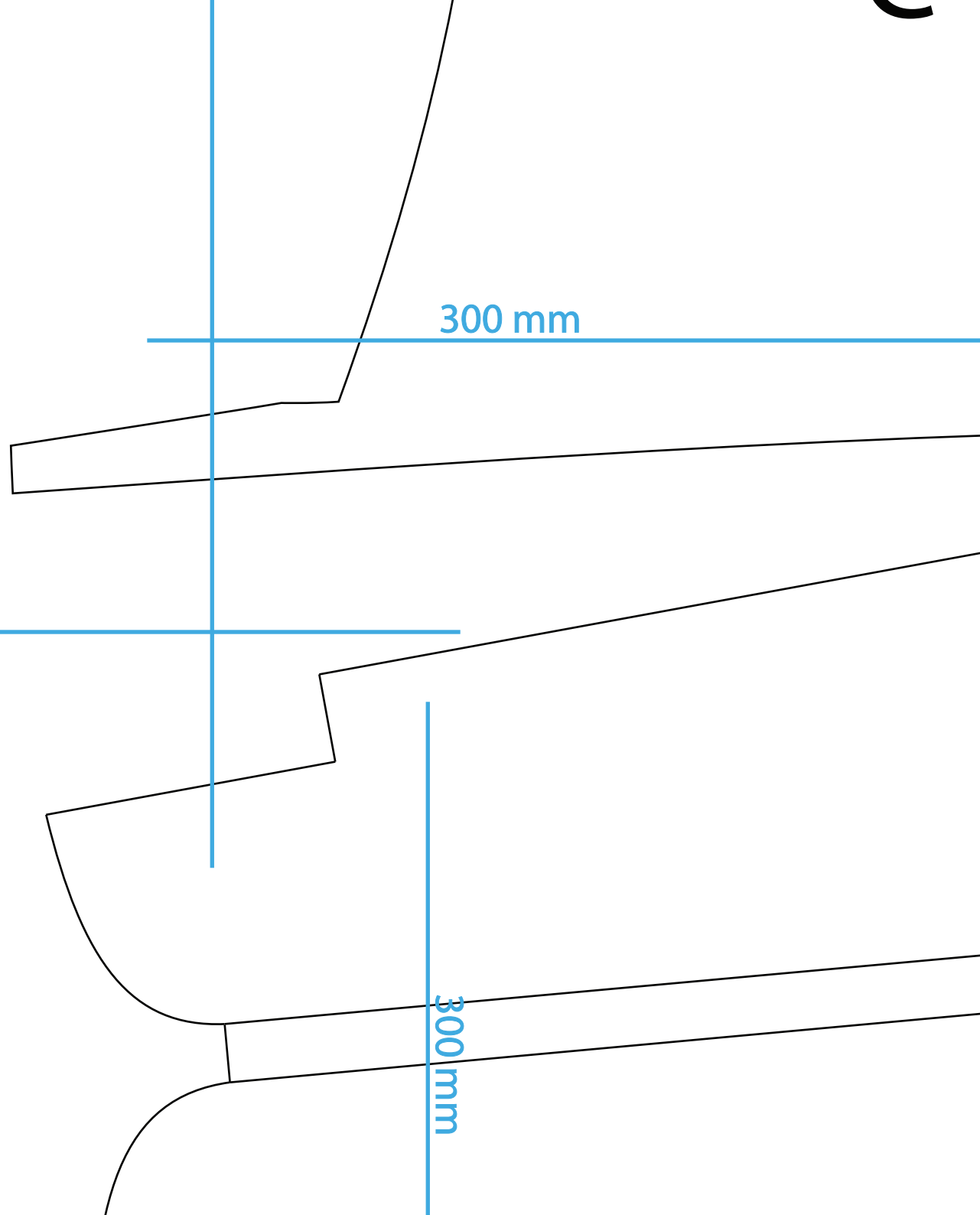
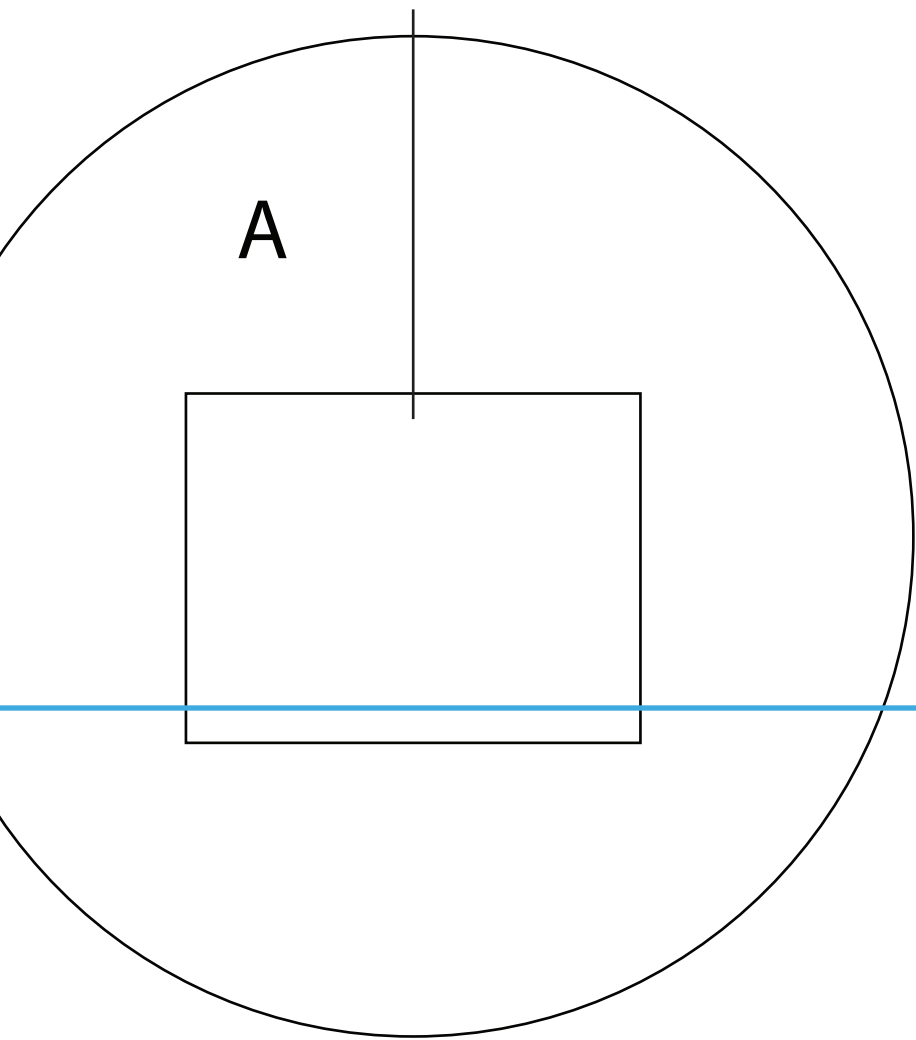



300 mm

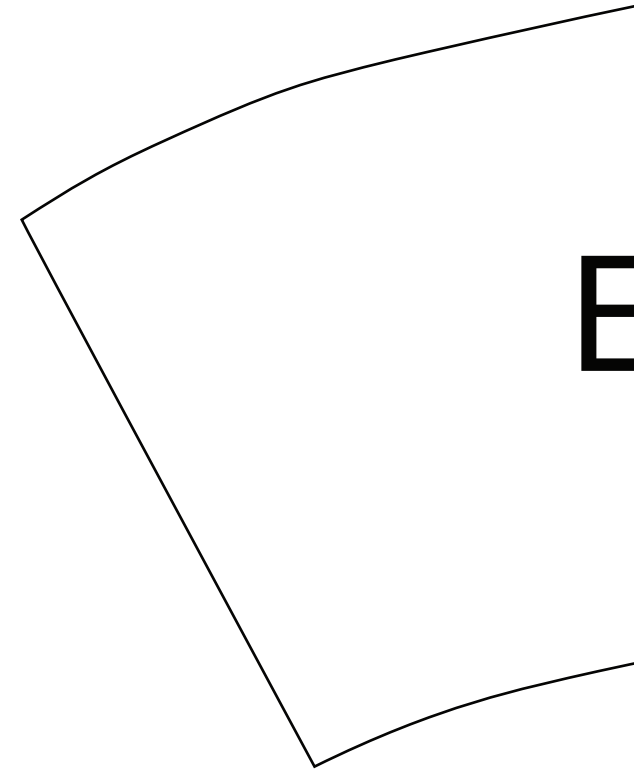
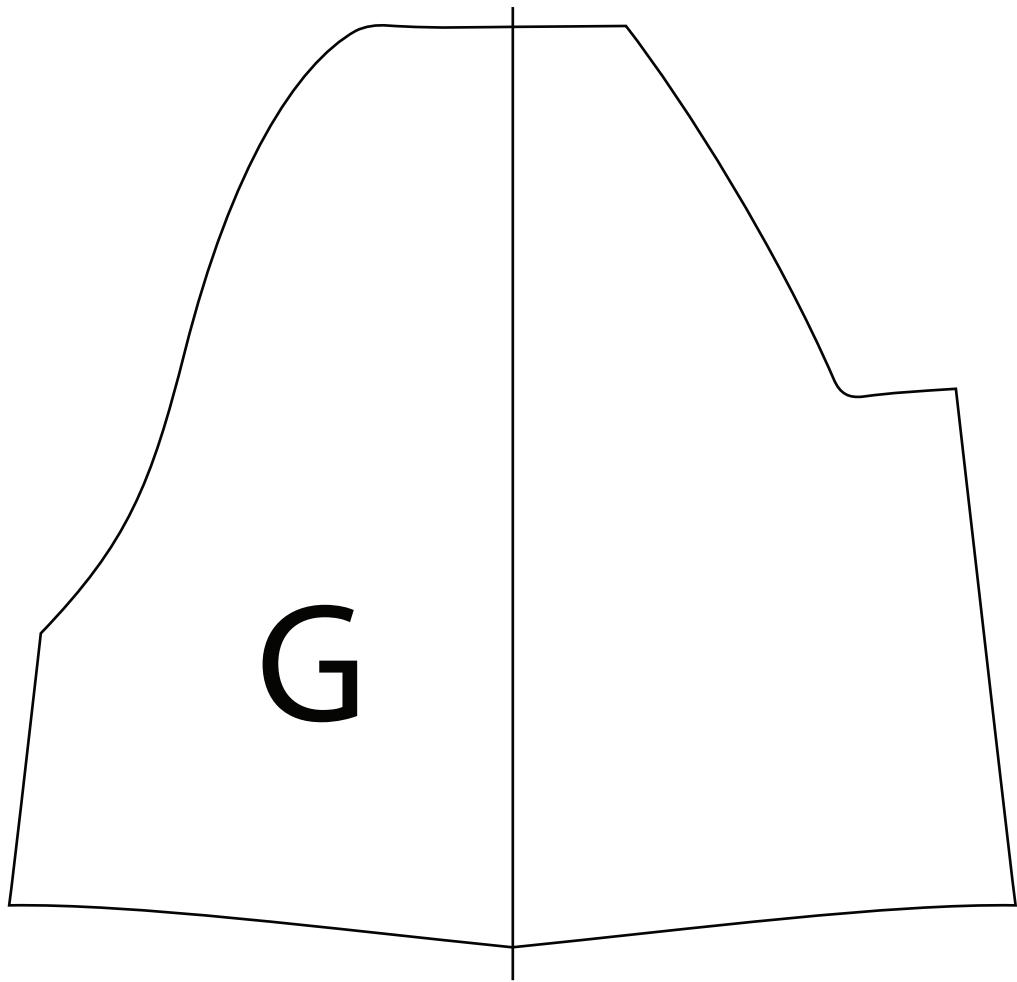

300 mm

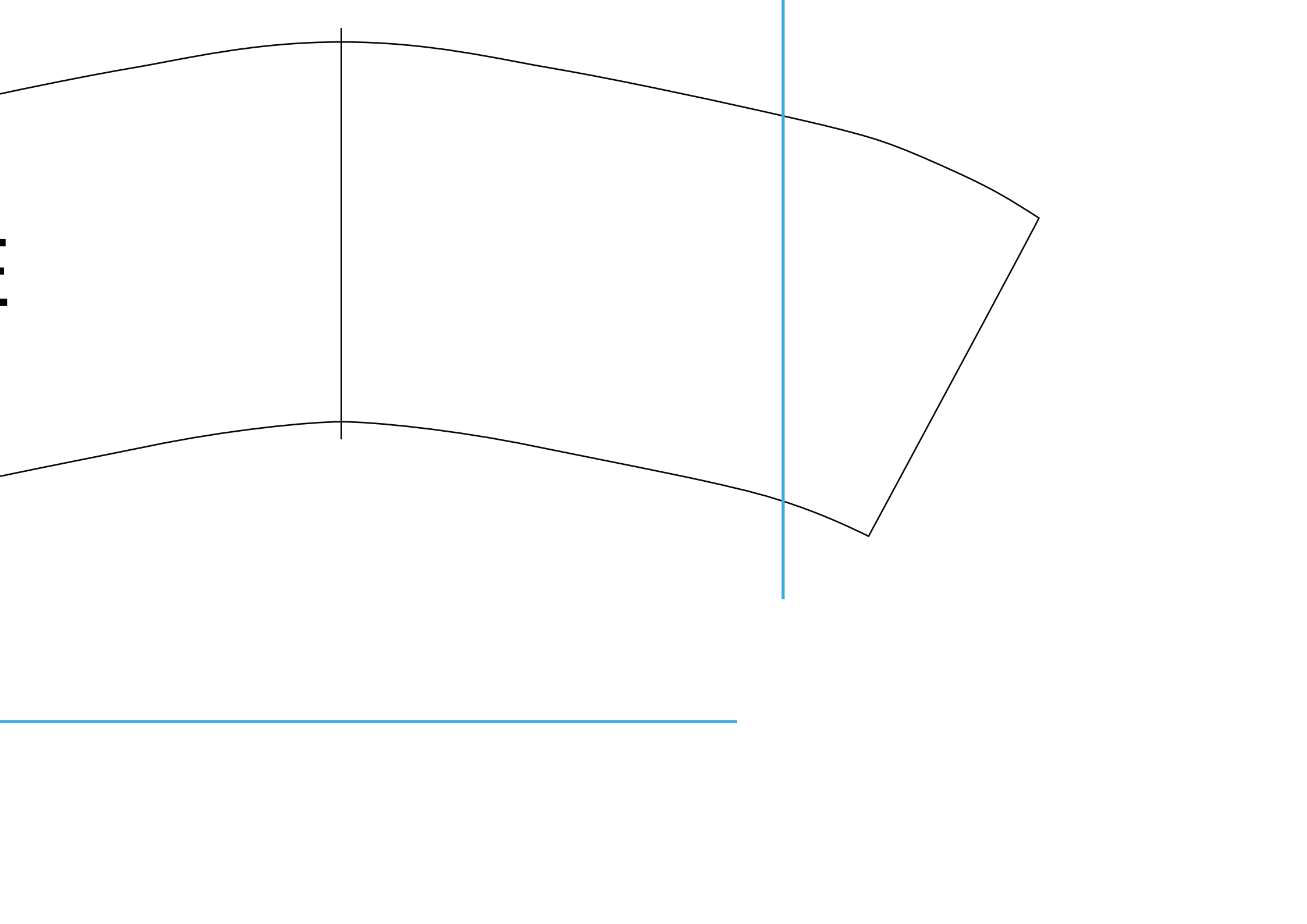

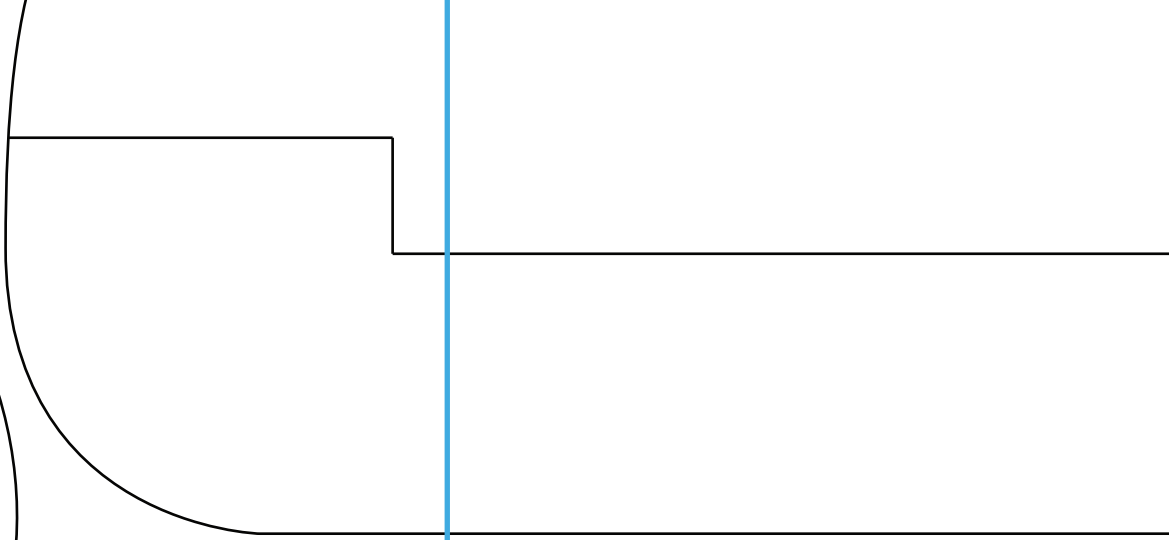
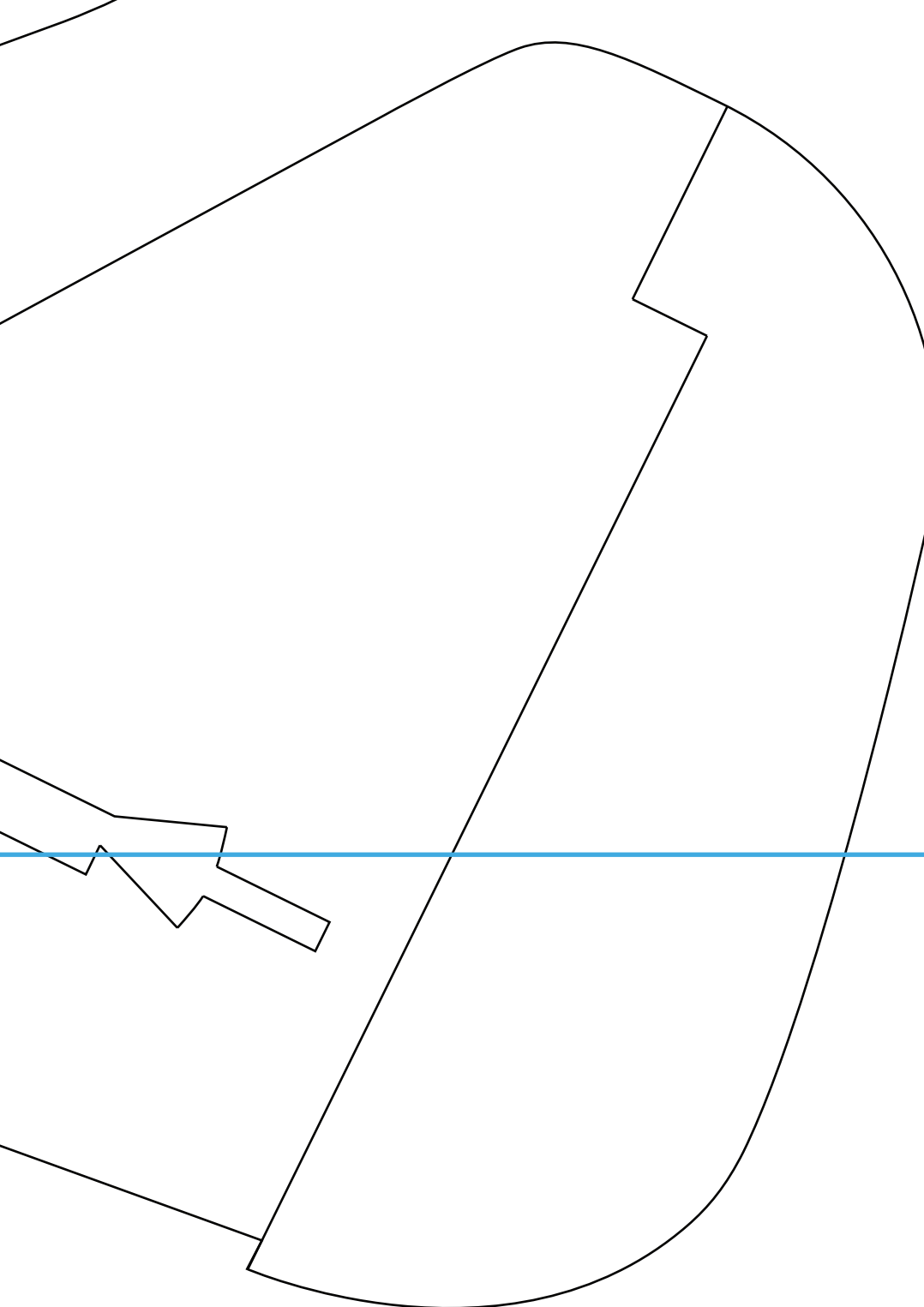

300 mm



13

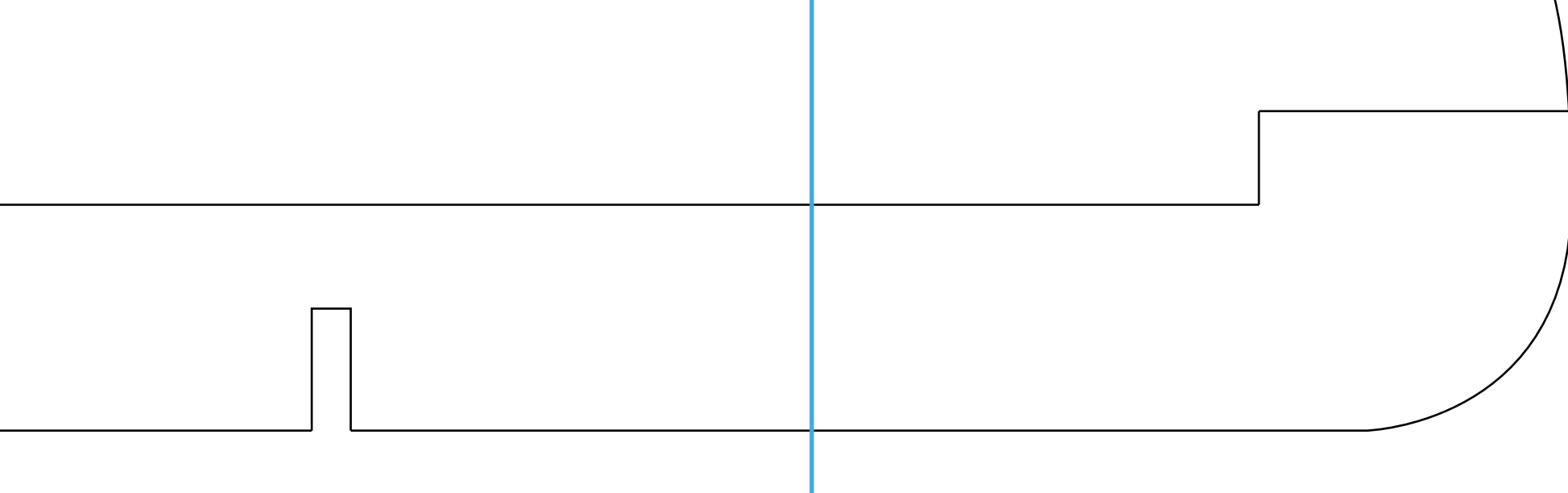

# New Decals / Resized

