

Side view of Hatch / Canopy piece.

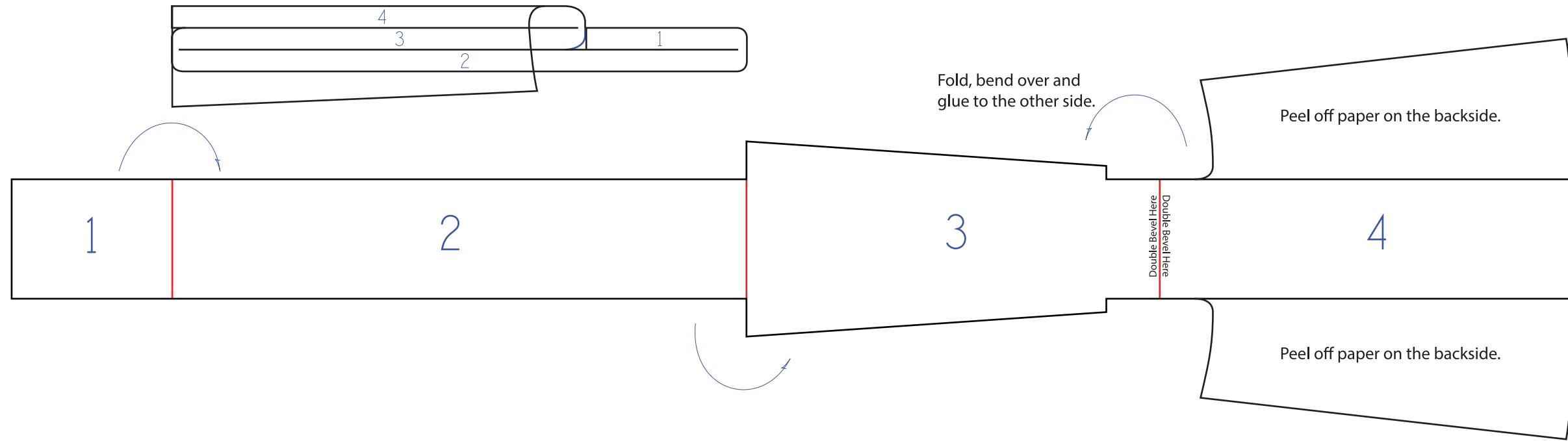

Glue to "D" formers first

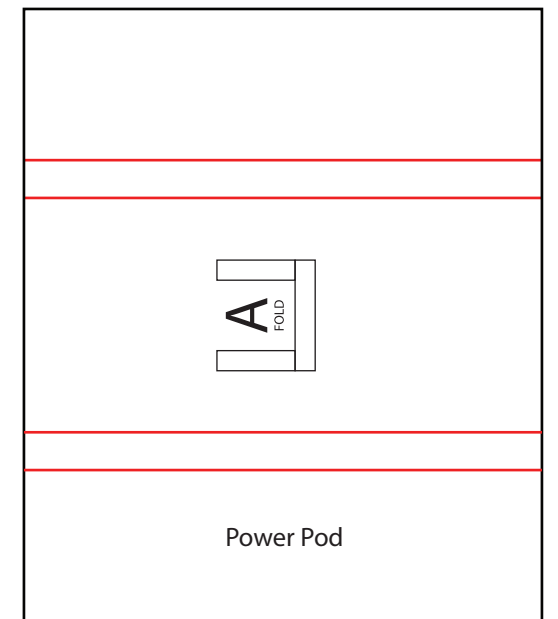

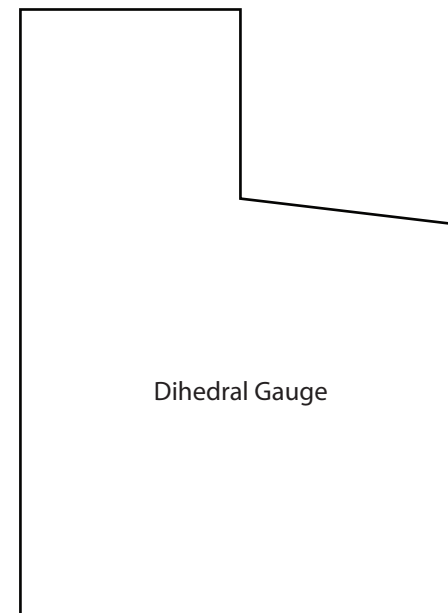
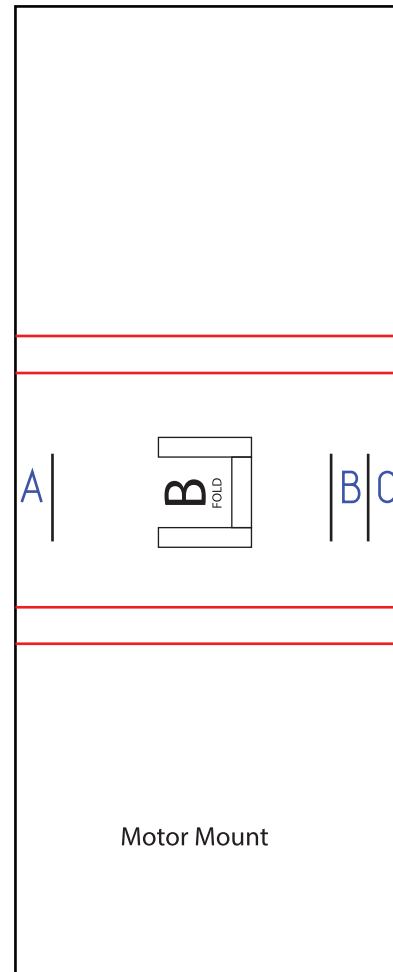
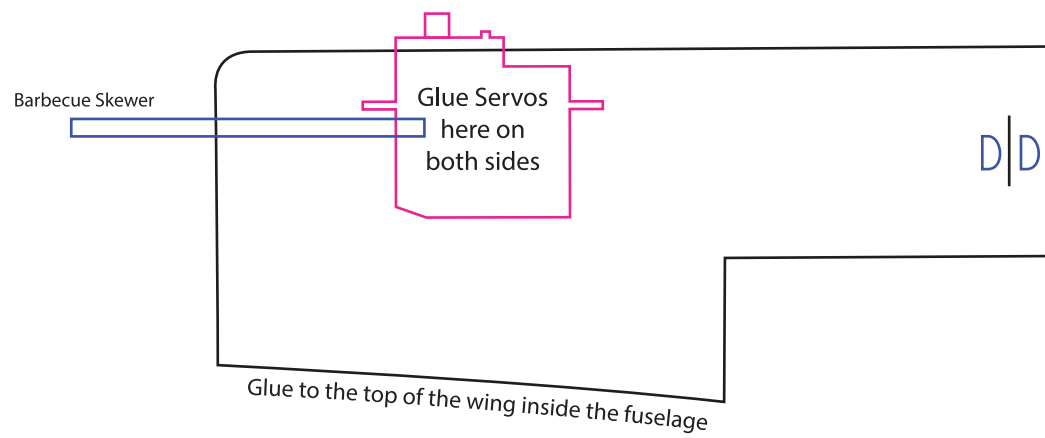
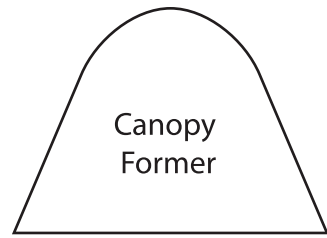

Canopy Former

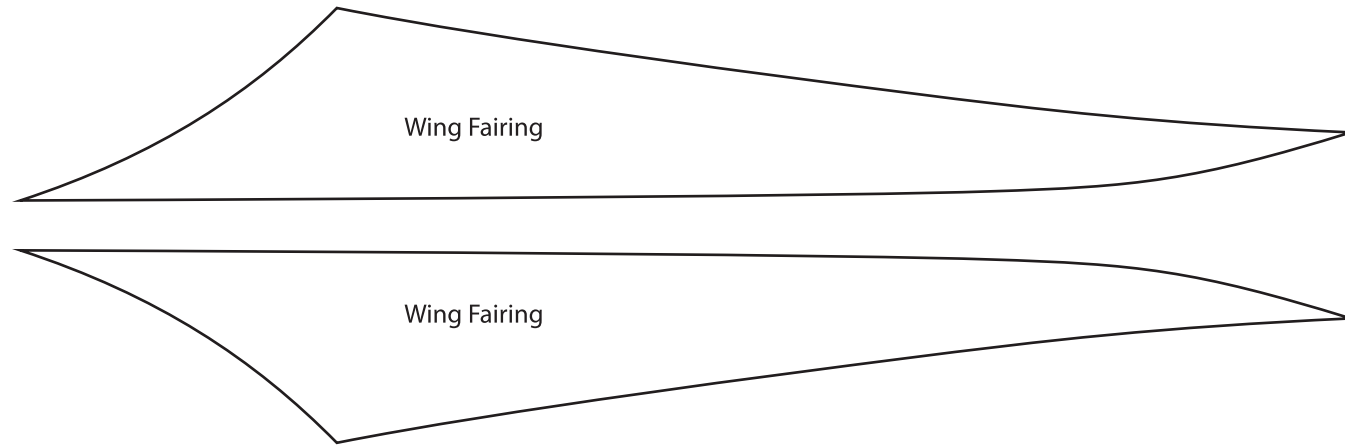

Wing Fairing

Wing Fairing

Exhaust Pieces
(Flatten the foam in a vice to make thinner.)

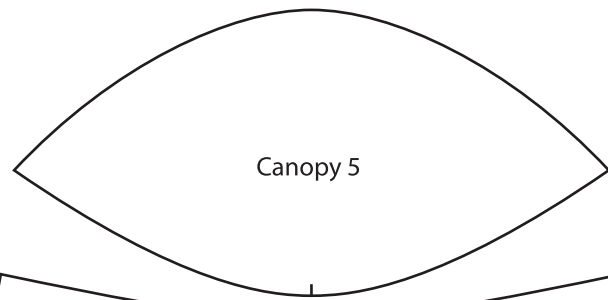
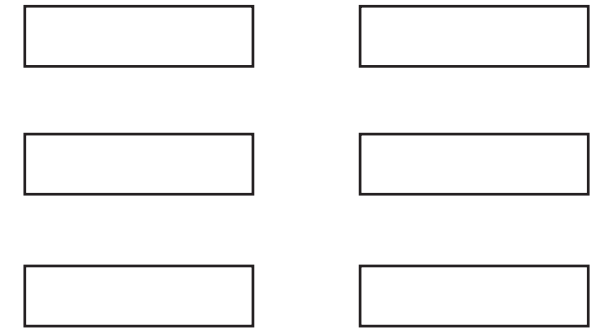

Canopy 5

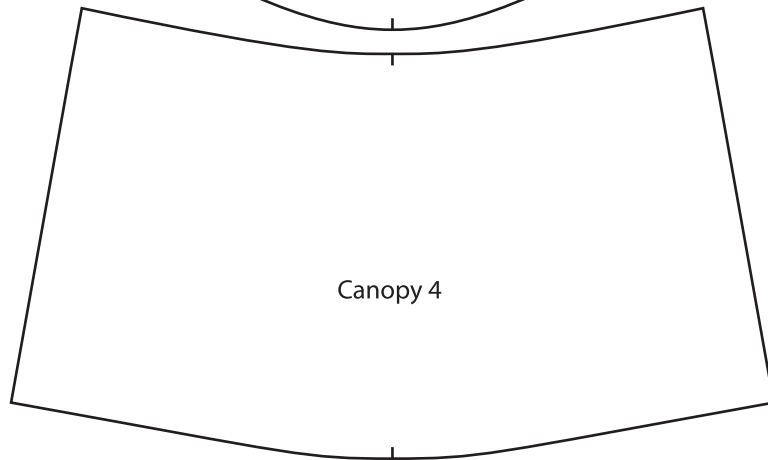

Canopy 4

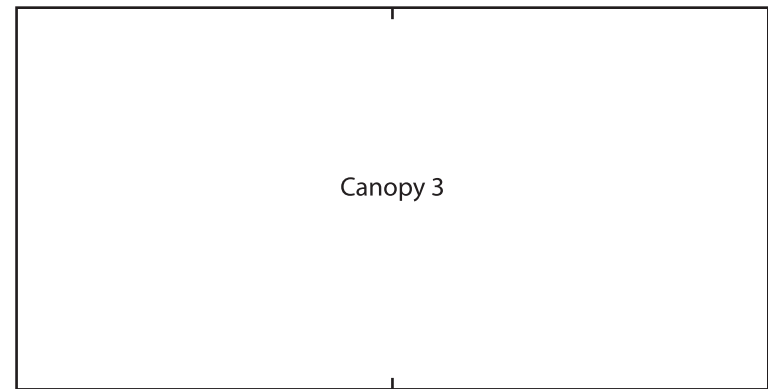

Canopy 3

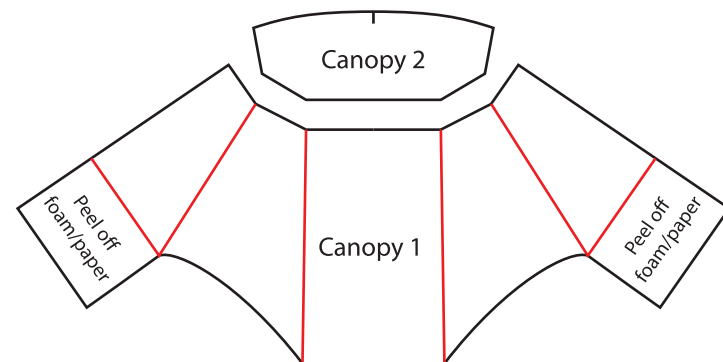

Canopy 2

Canopy 1

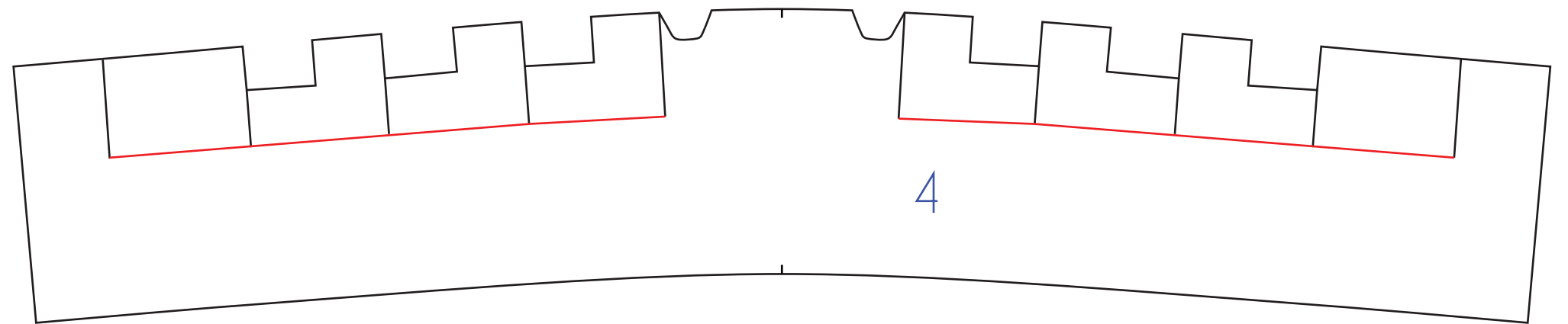

4

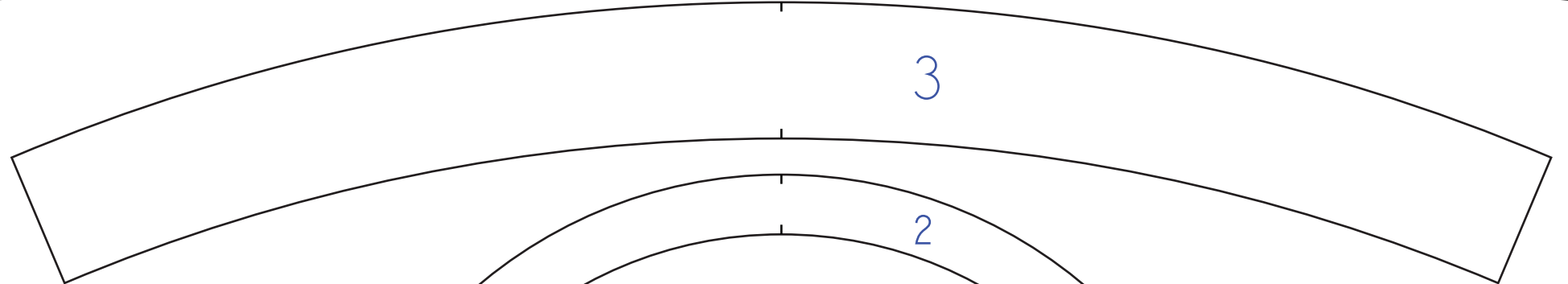

3

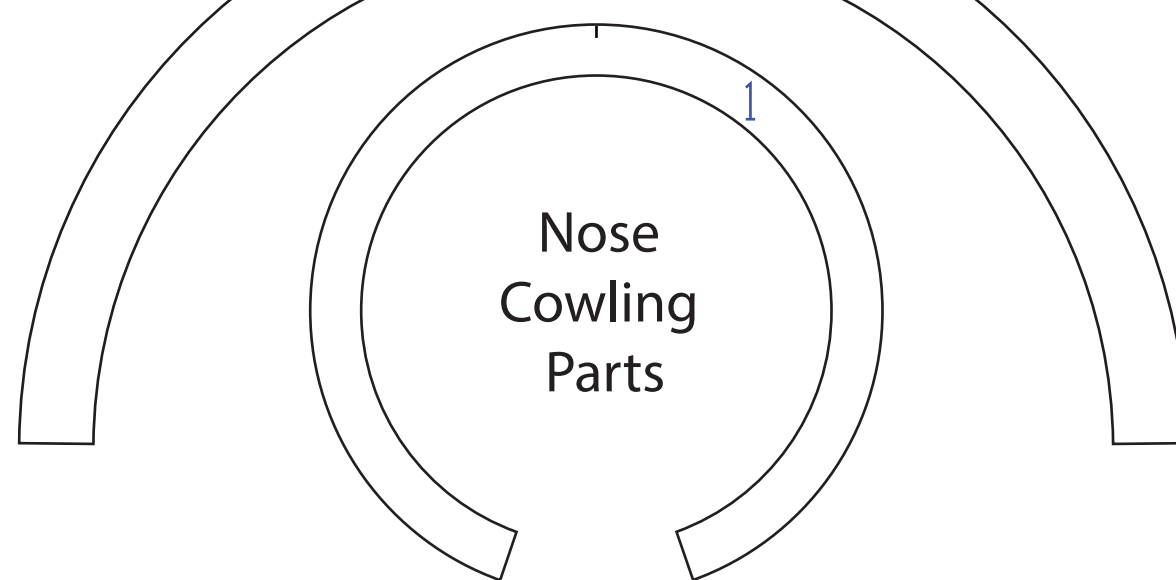

1

2

Nose Cowling Parts

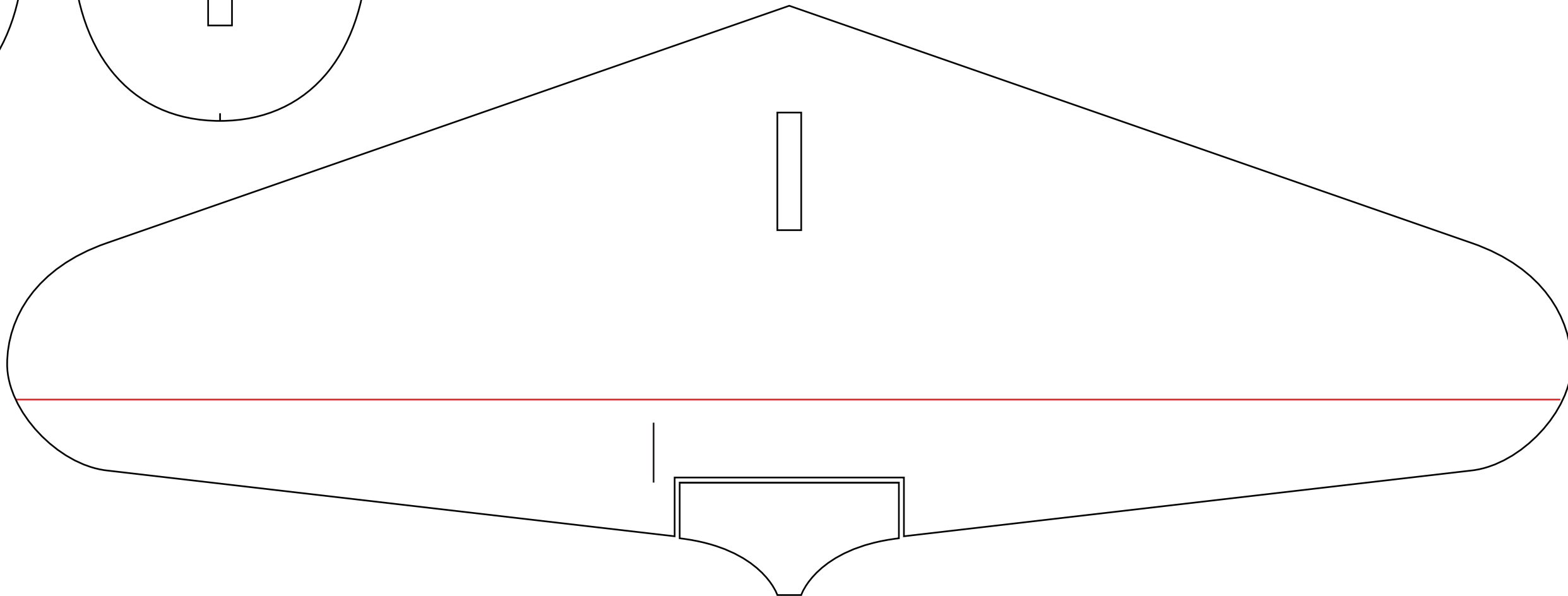
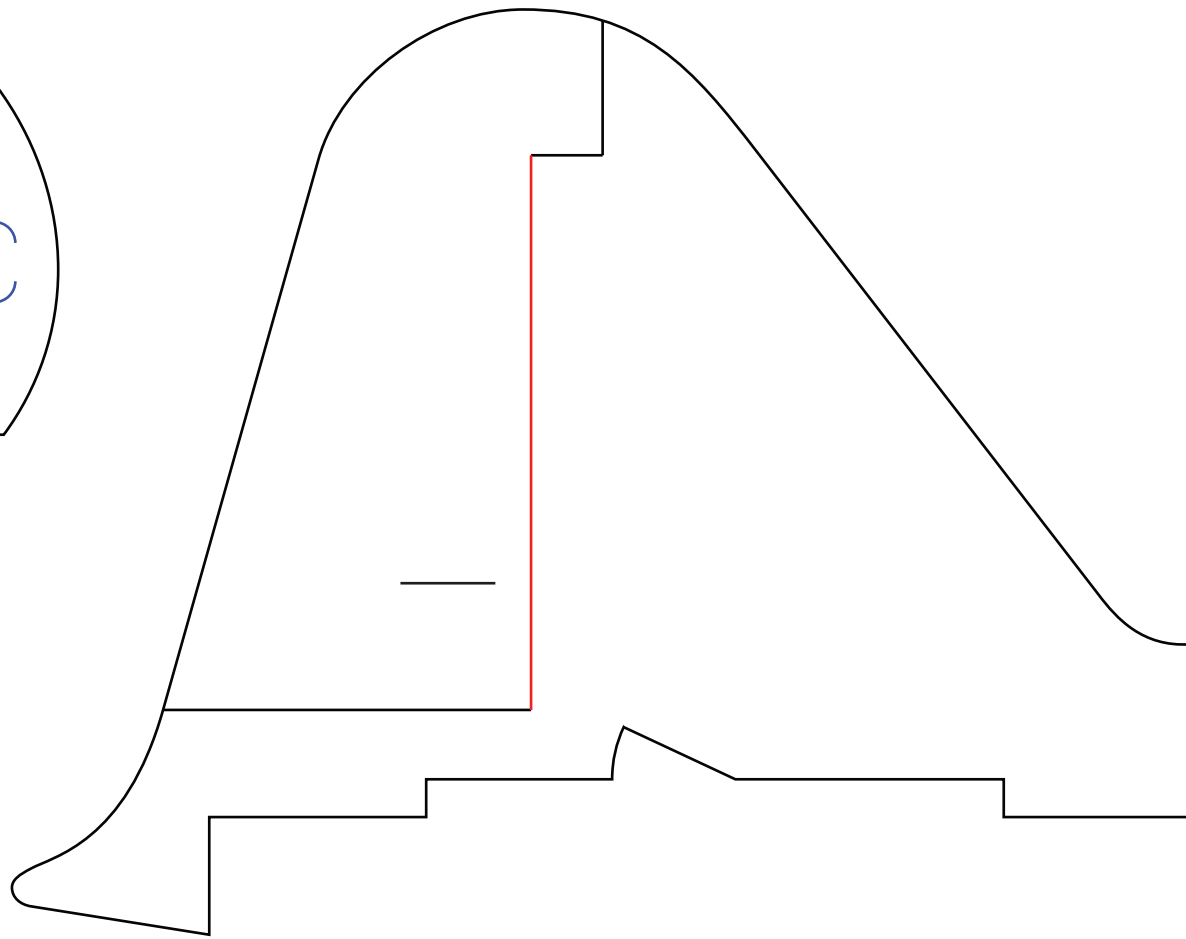
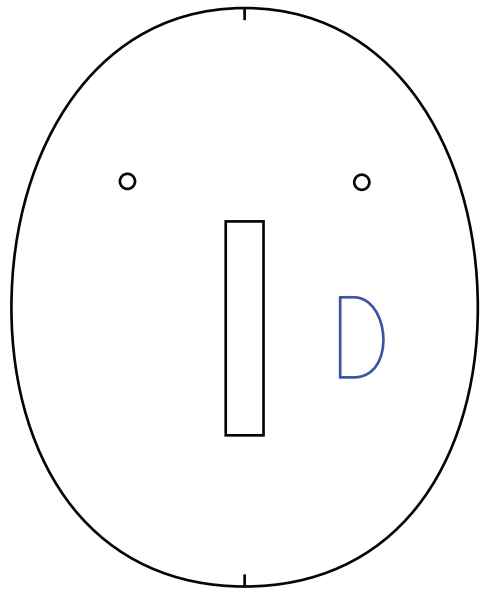
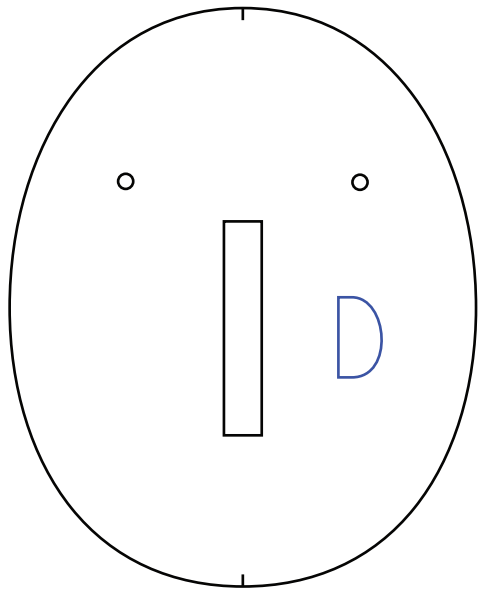
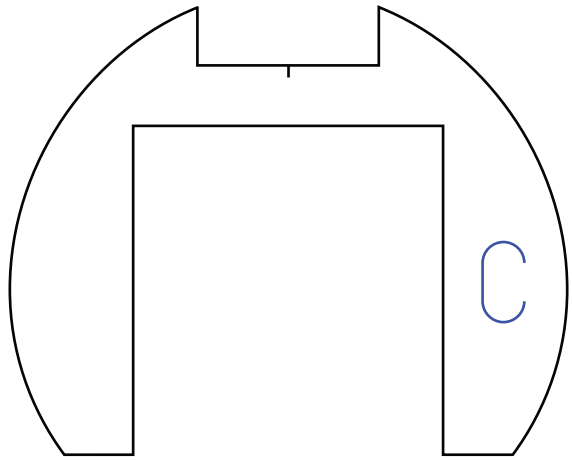
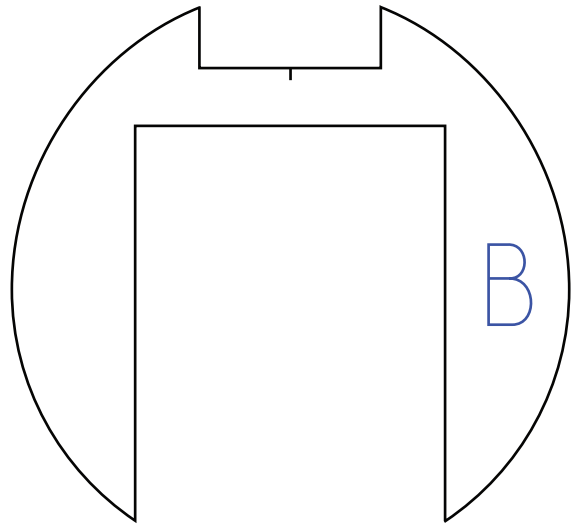
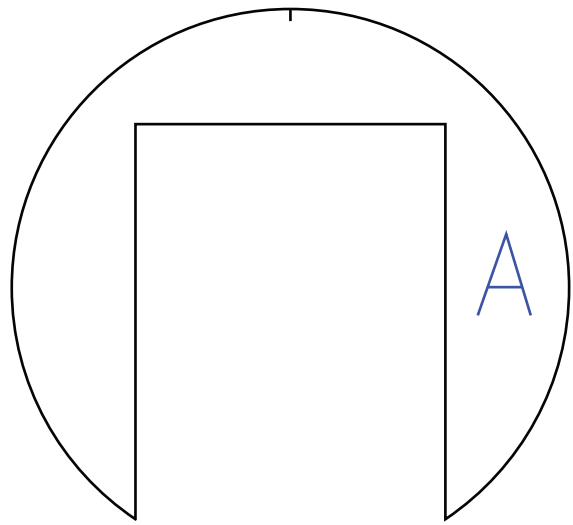

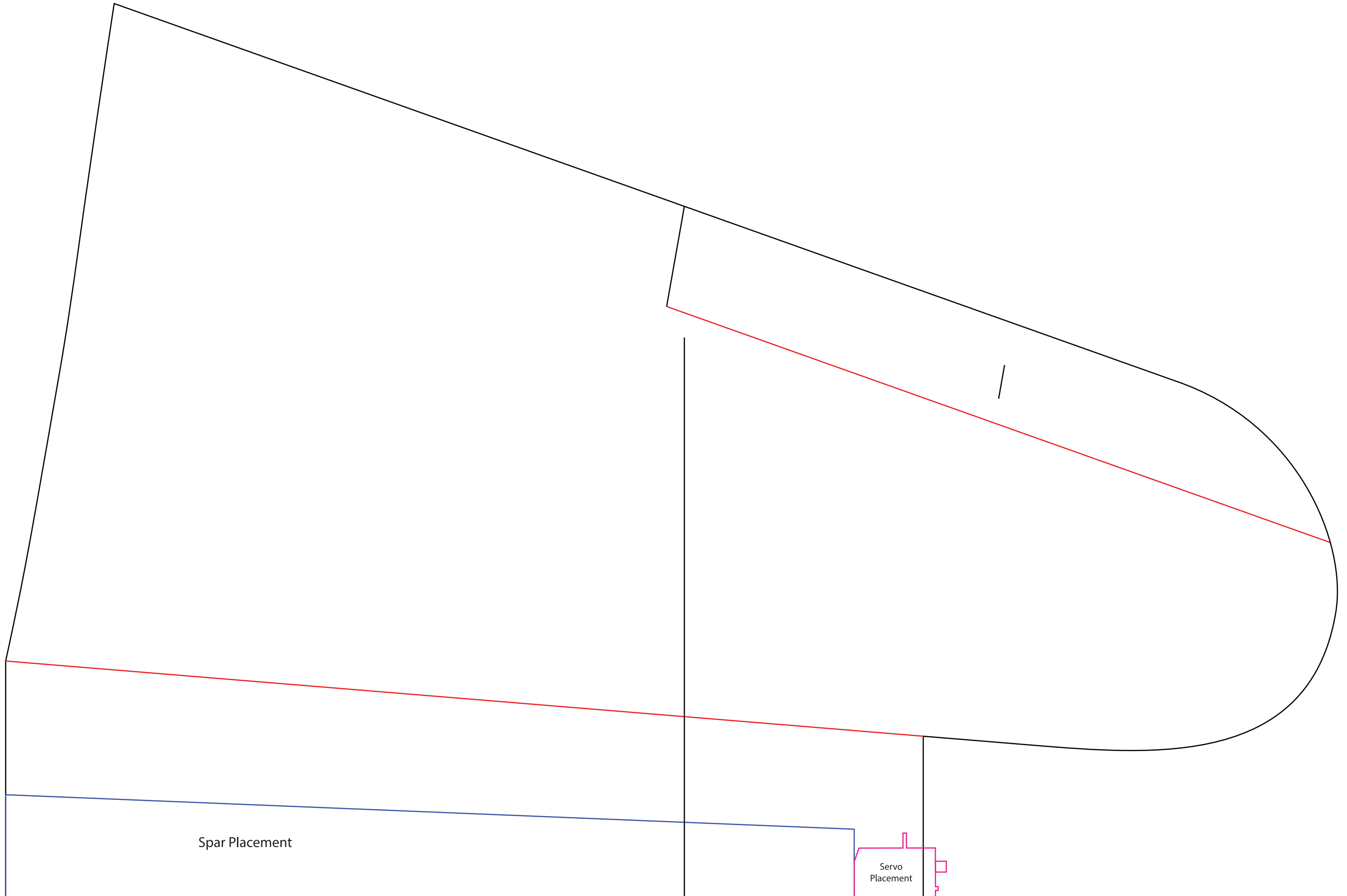

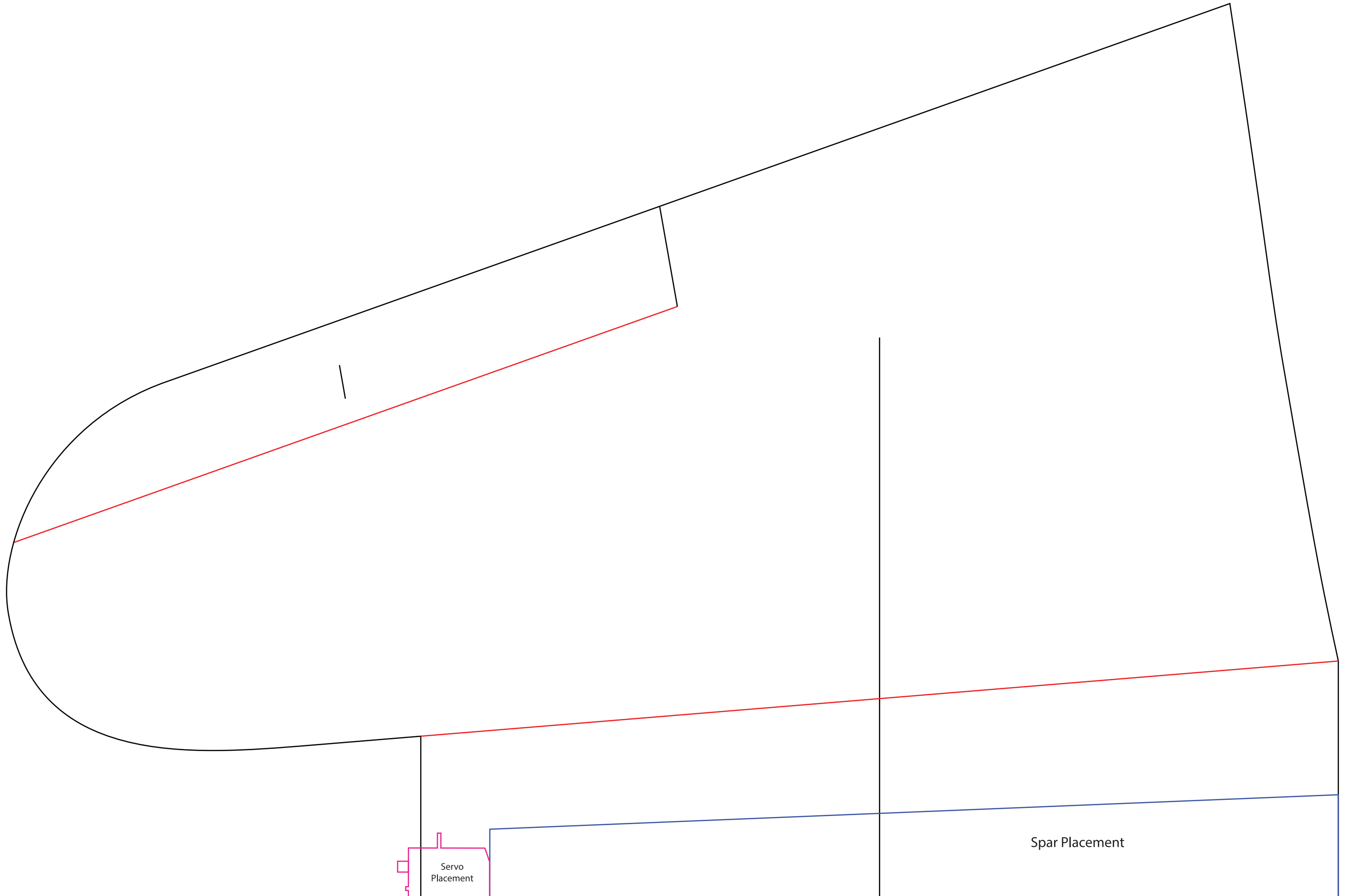

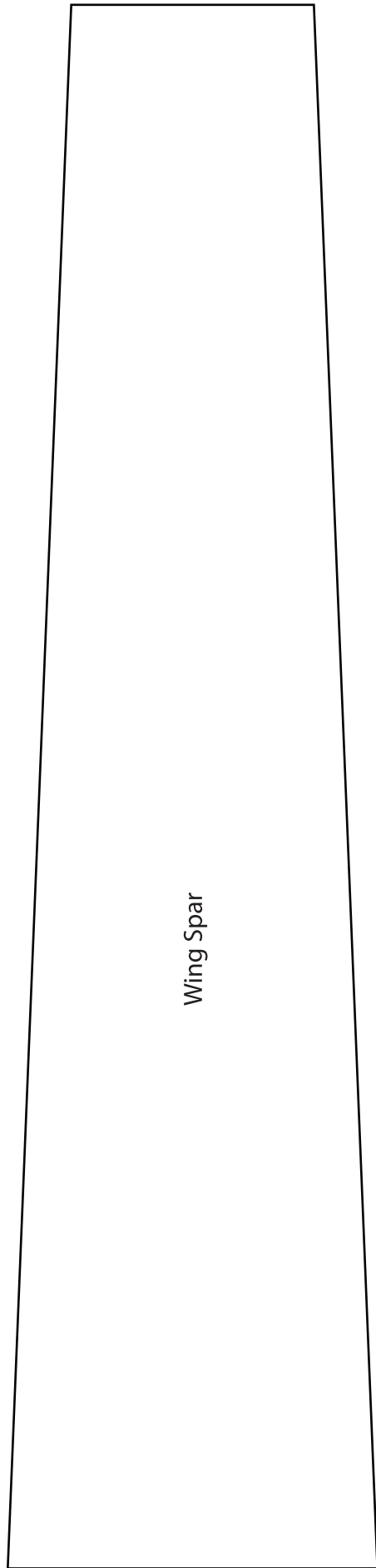

Wing Spar

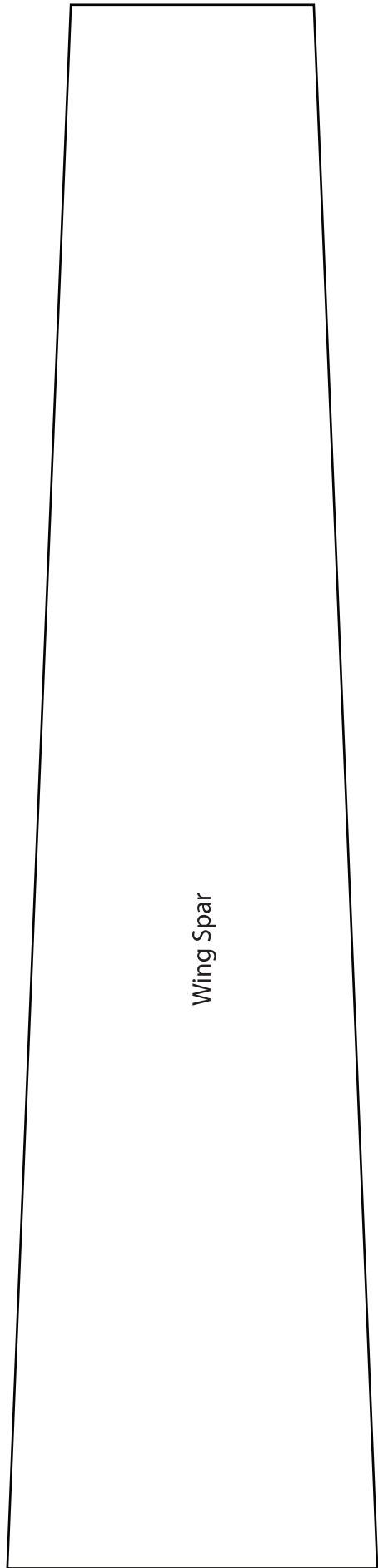

Wing Spar

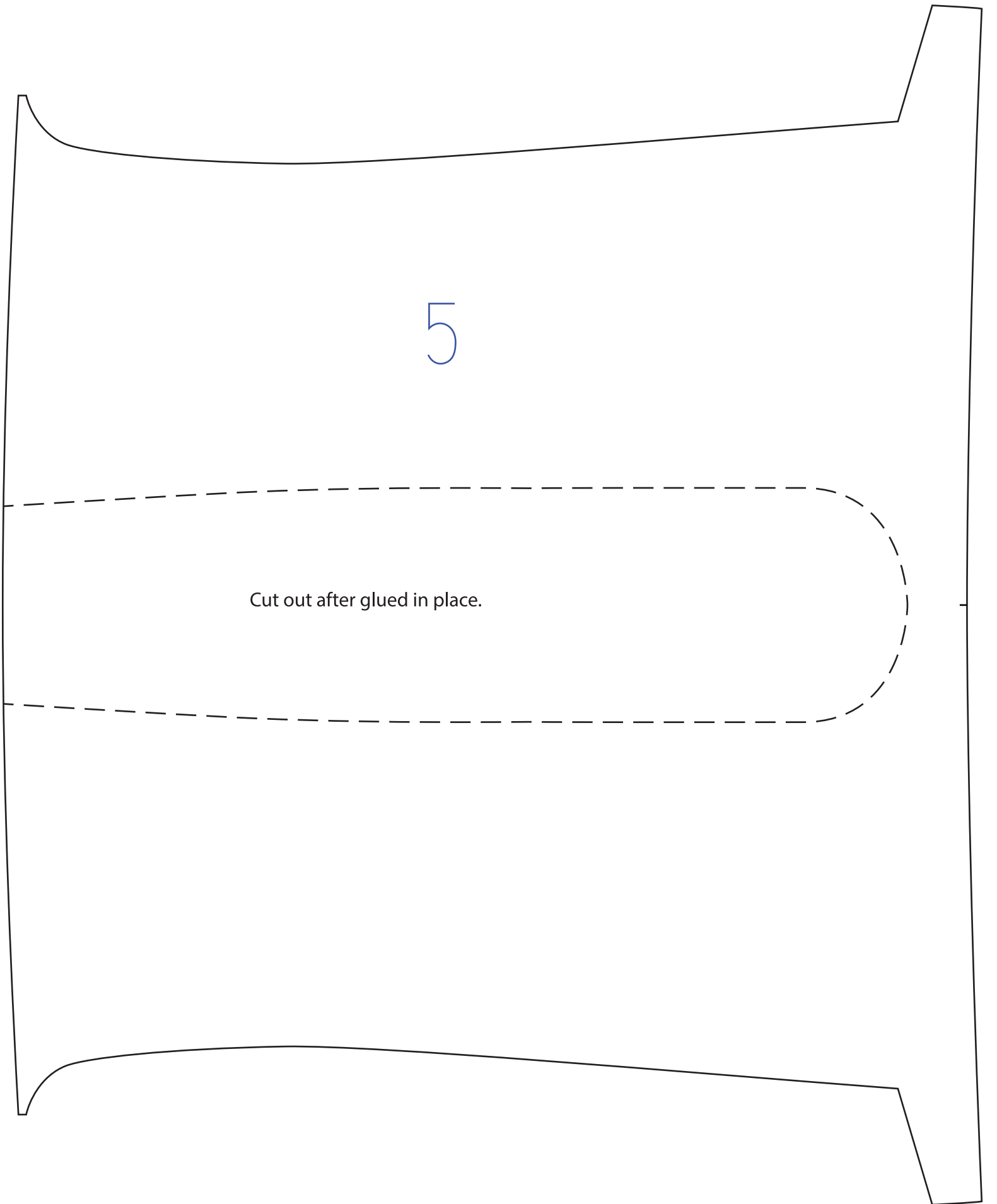

5

Cut out after glued in place.

6

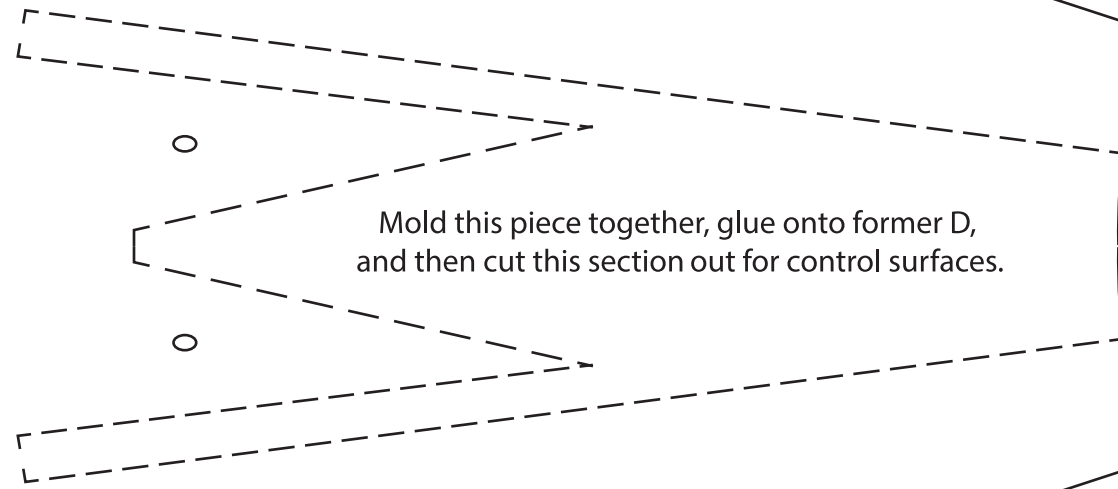

Copyright ©2020 13thSquadron. All Rights Reserved.
Commercial use of our plans are prohibited.

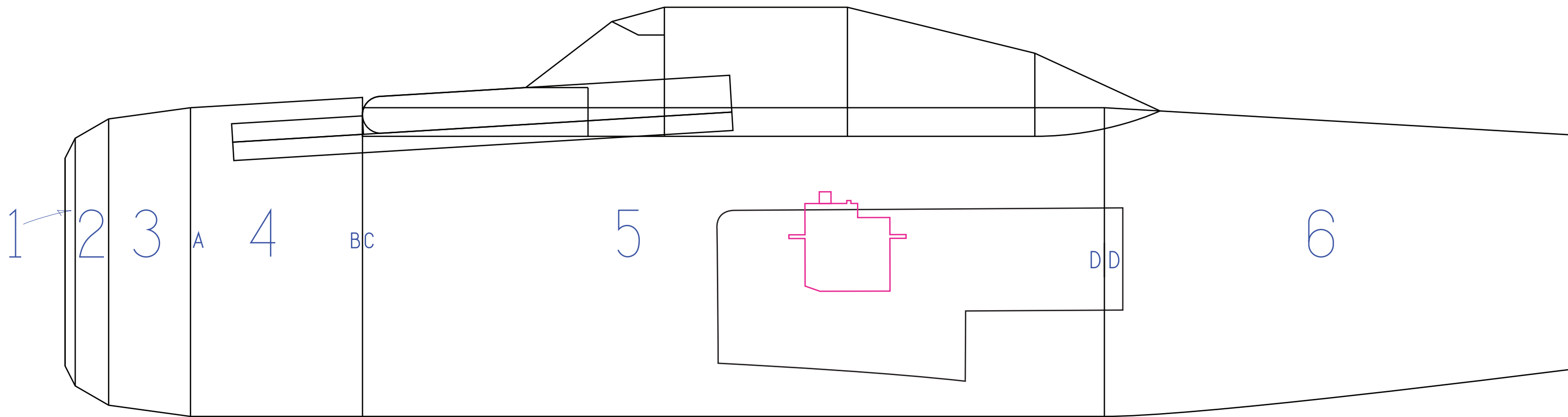

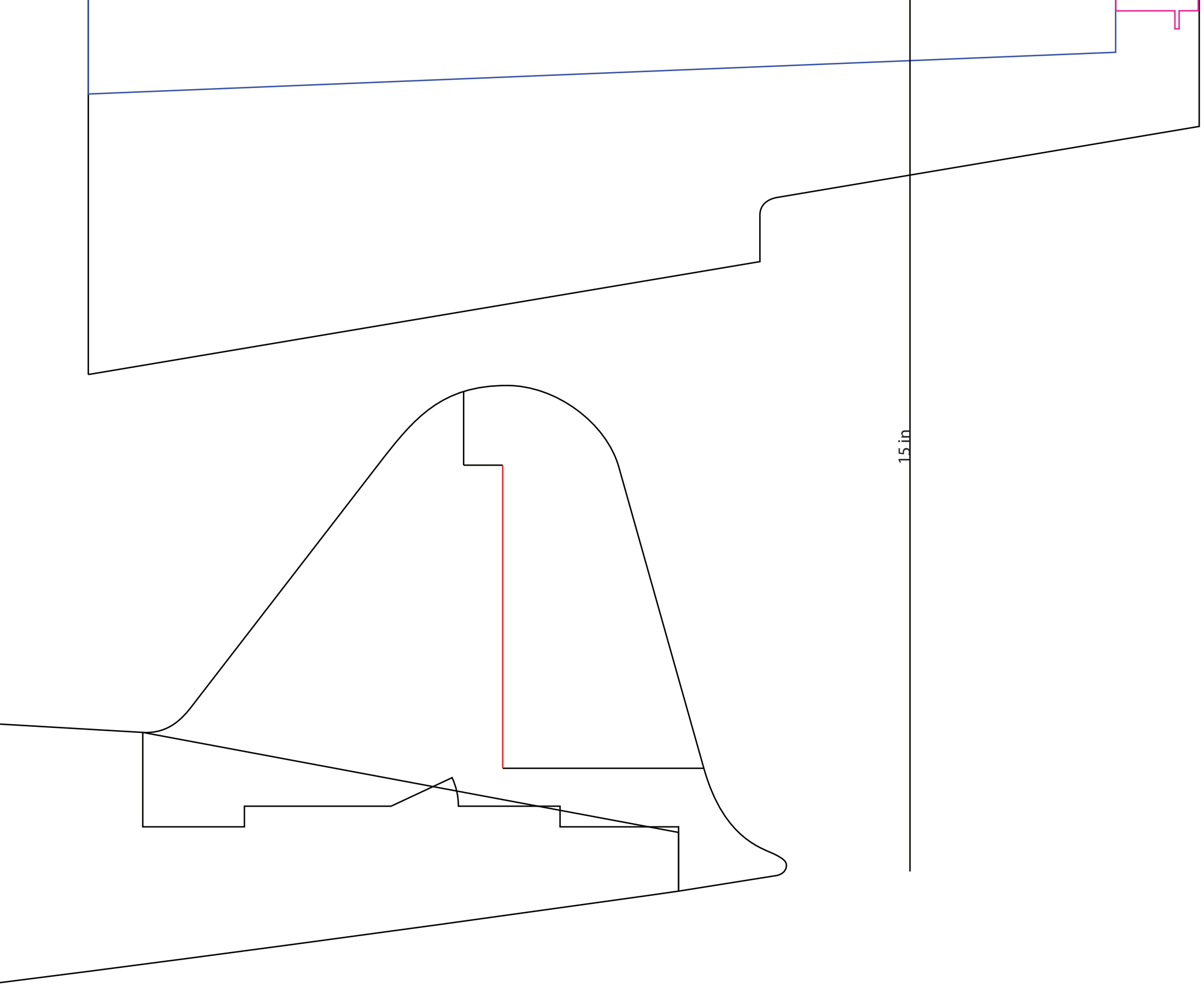

15 in

