

Side view of Hatch / Canopy piece.

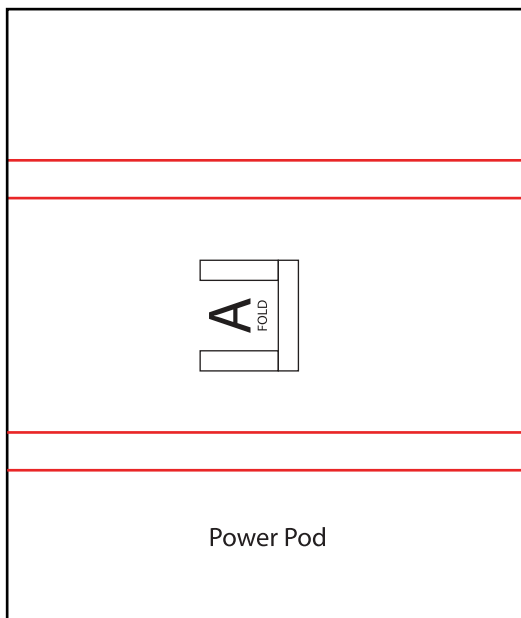

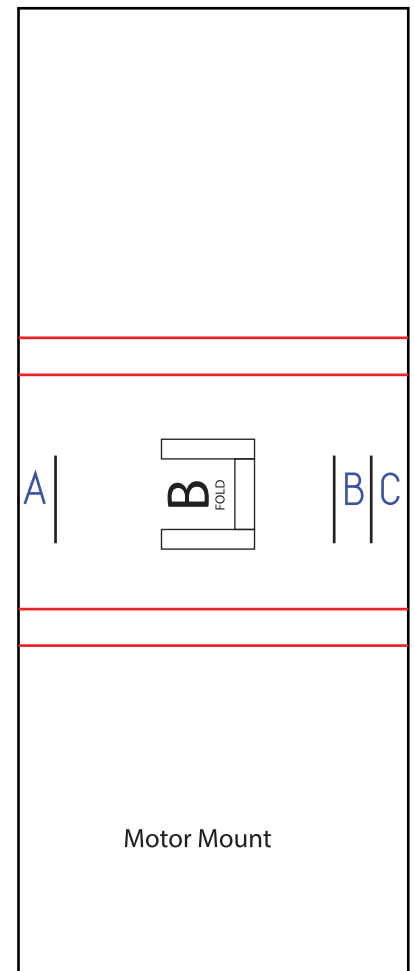

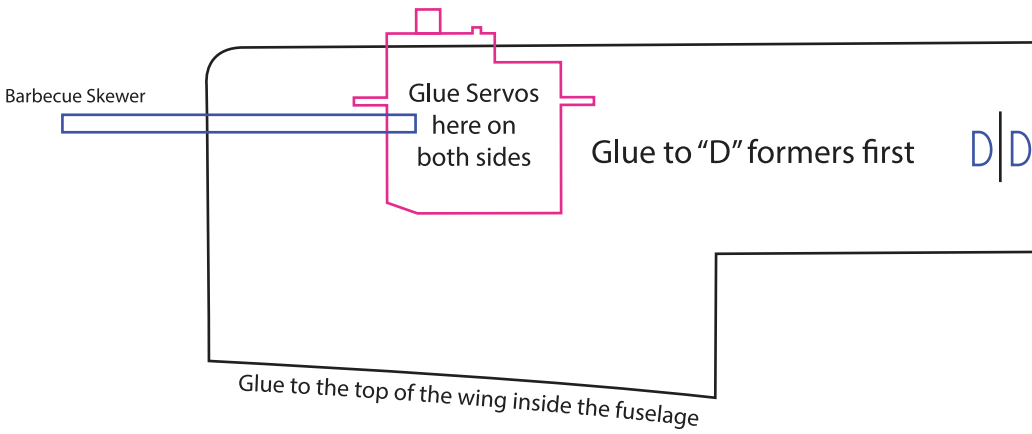
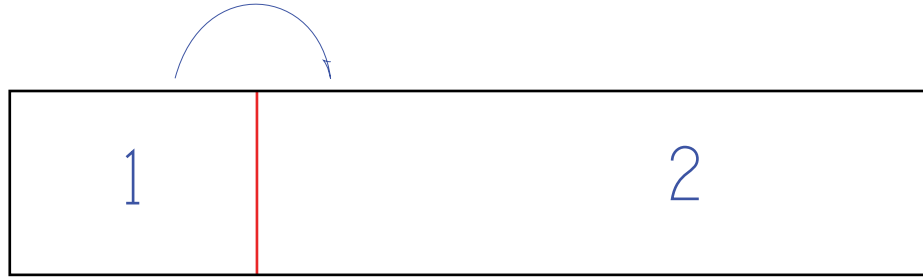
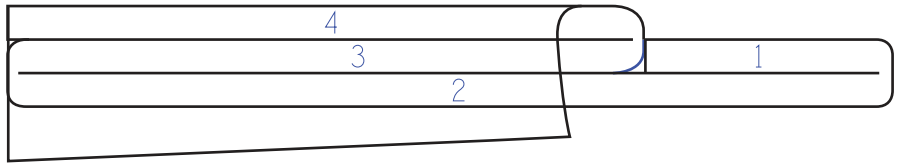
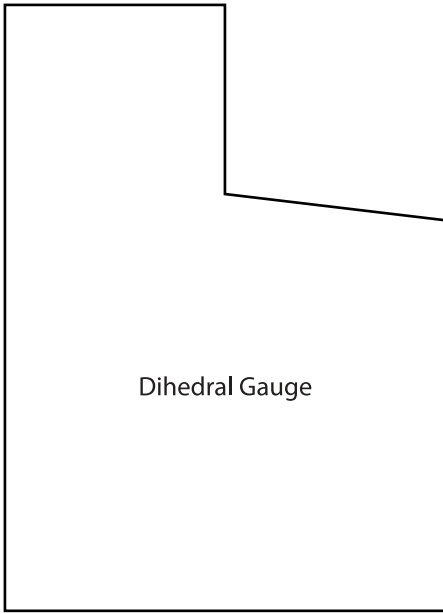
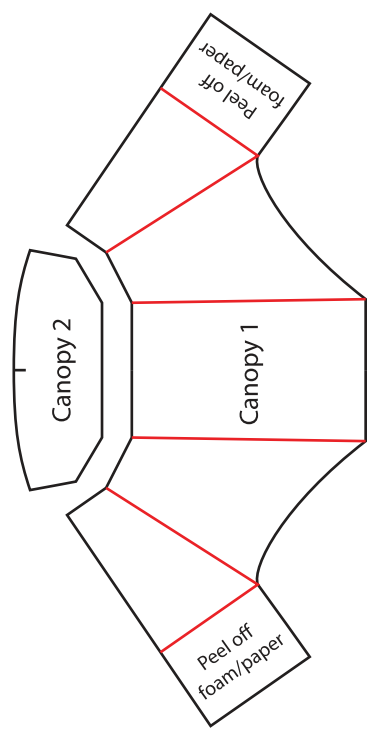
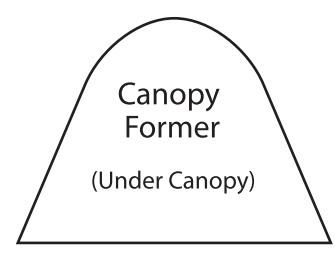
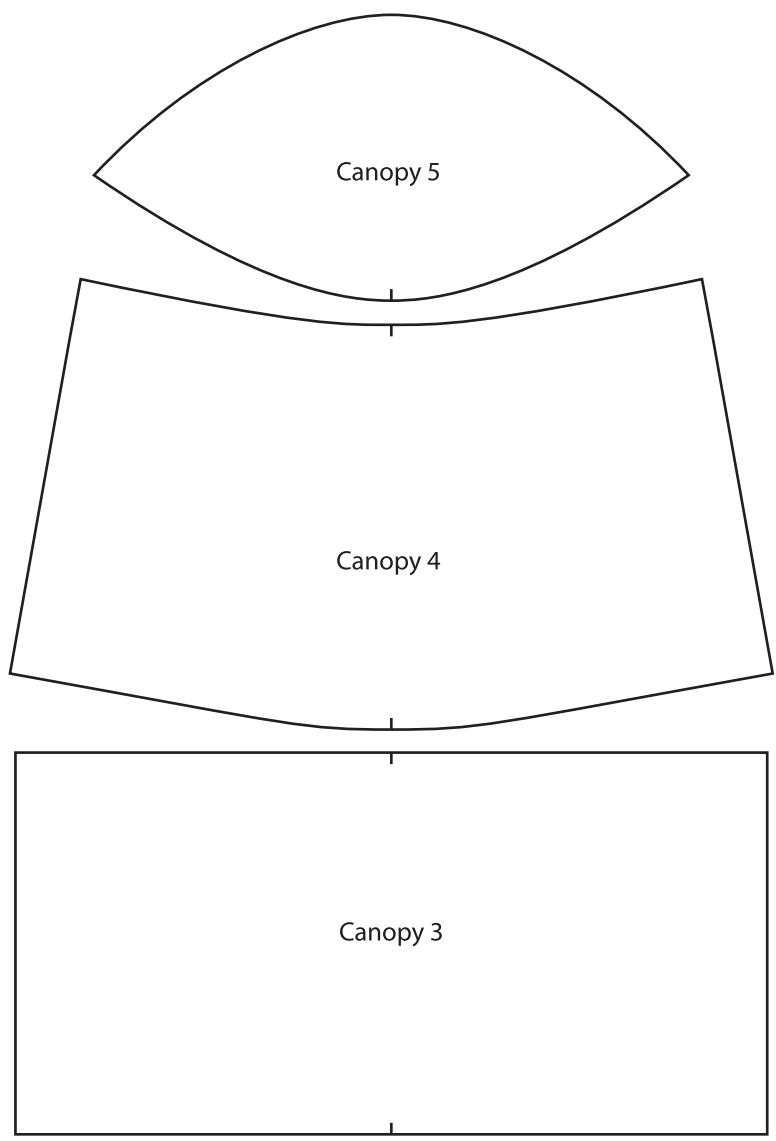
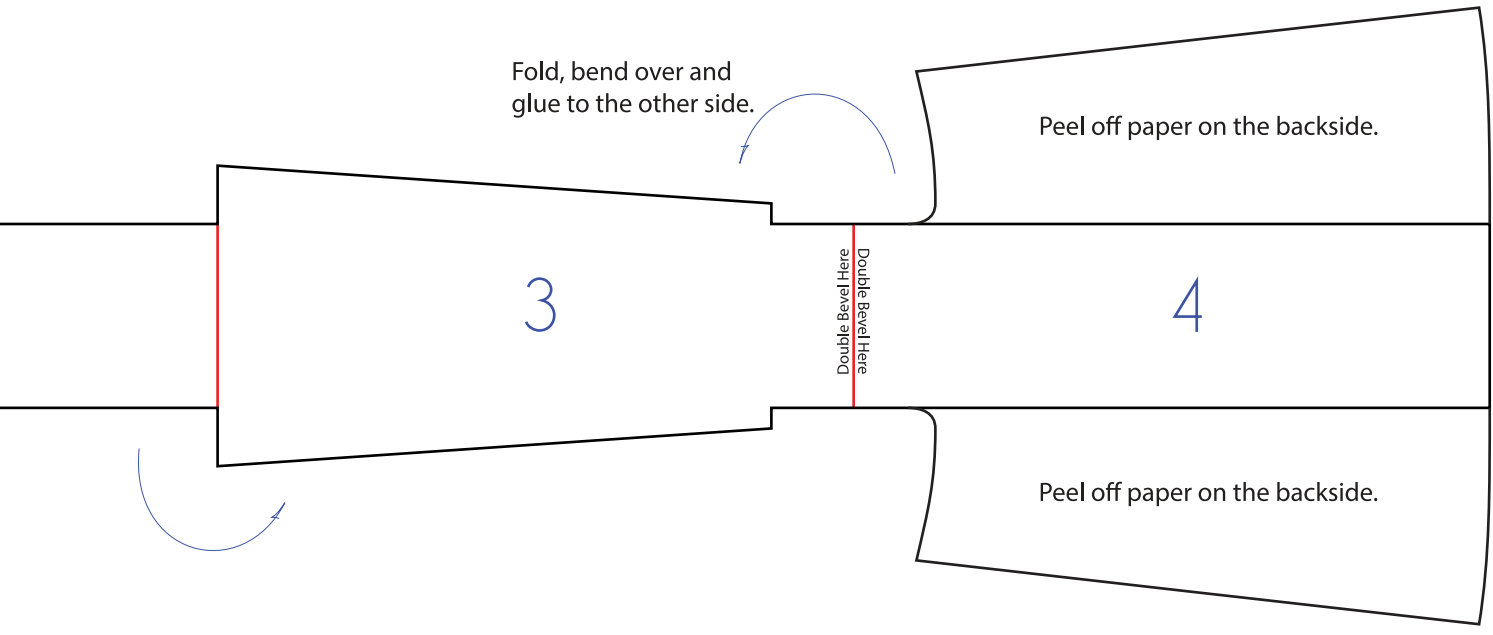
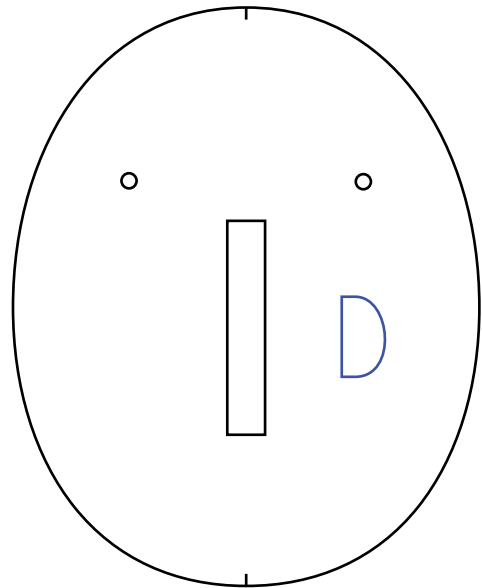
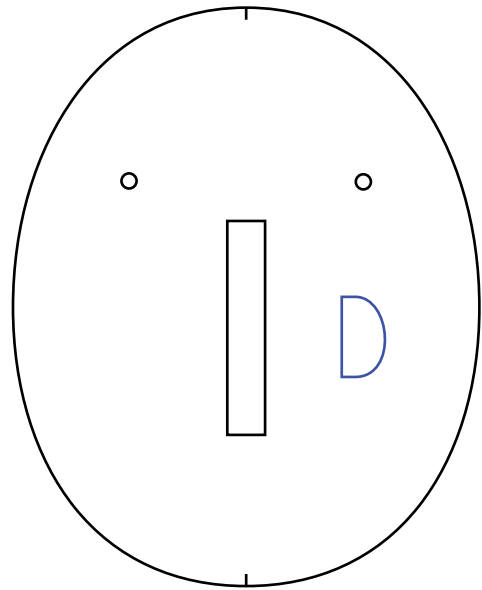
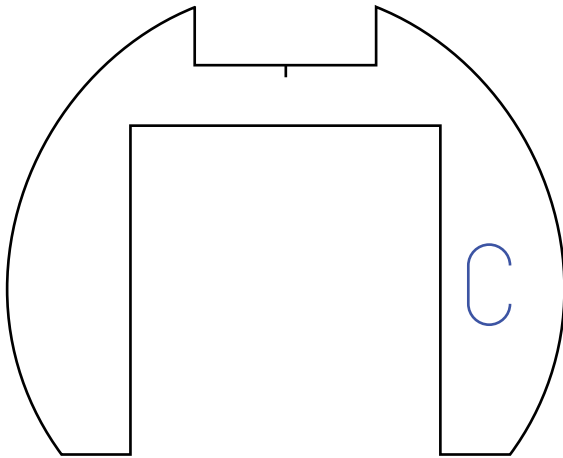
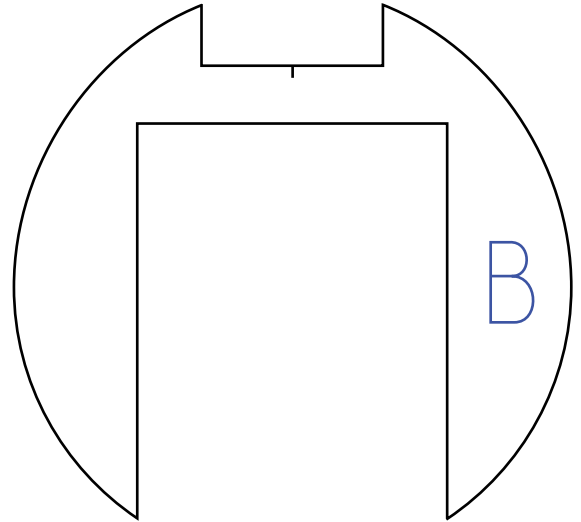
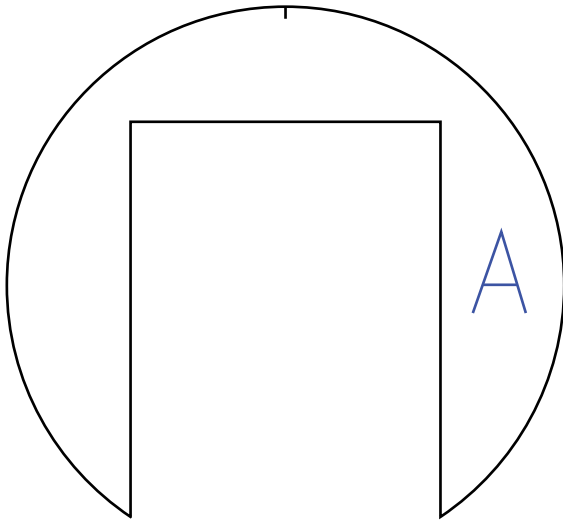

Exhaust Pieces
(Flatten the foam in a vice to make thinner.)

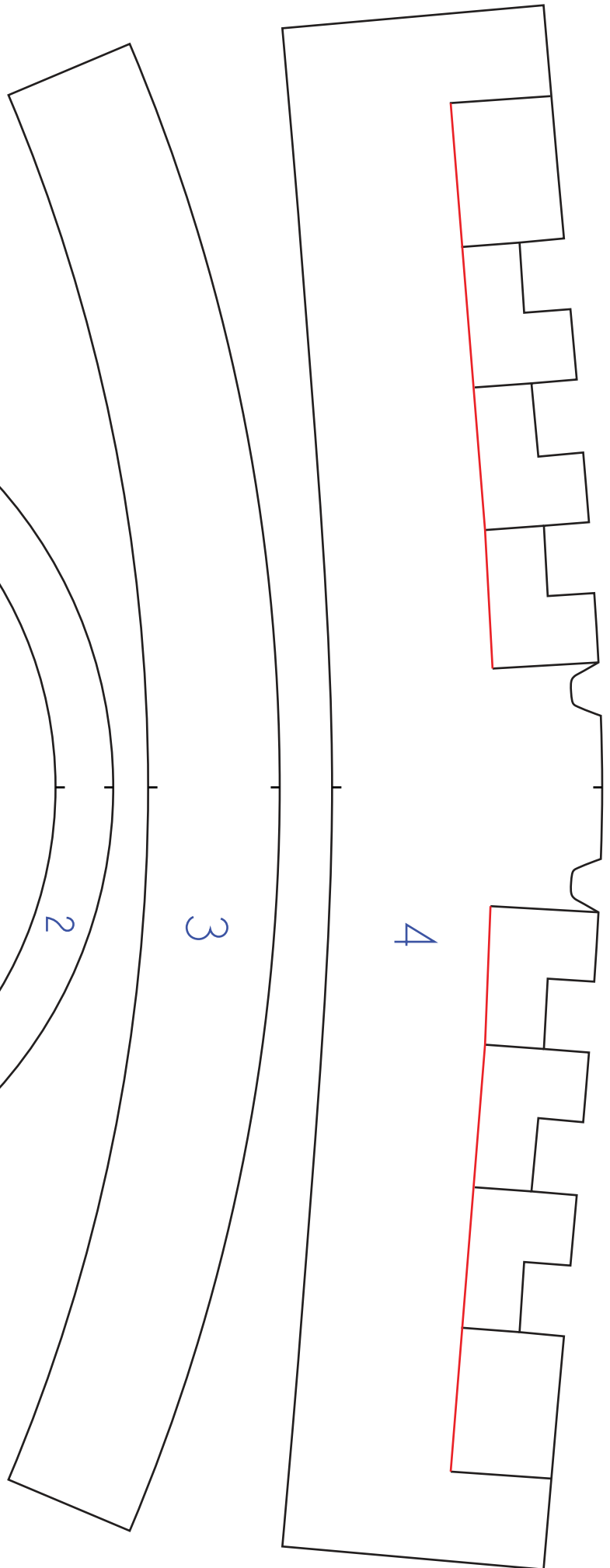
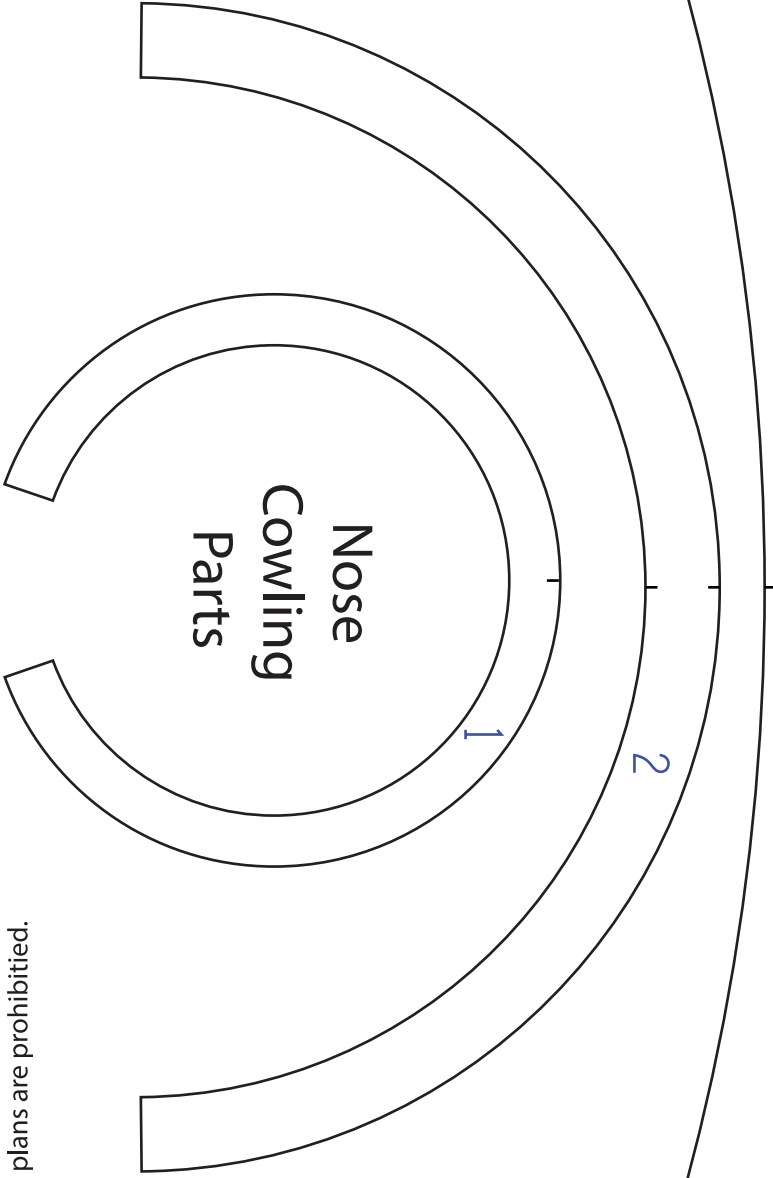
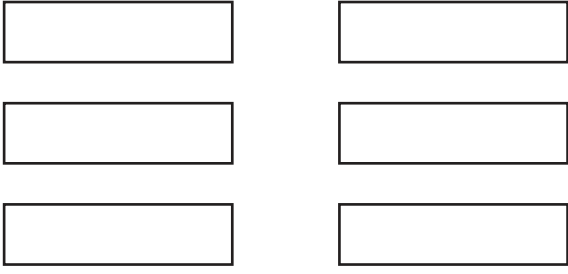

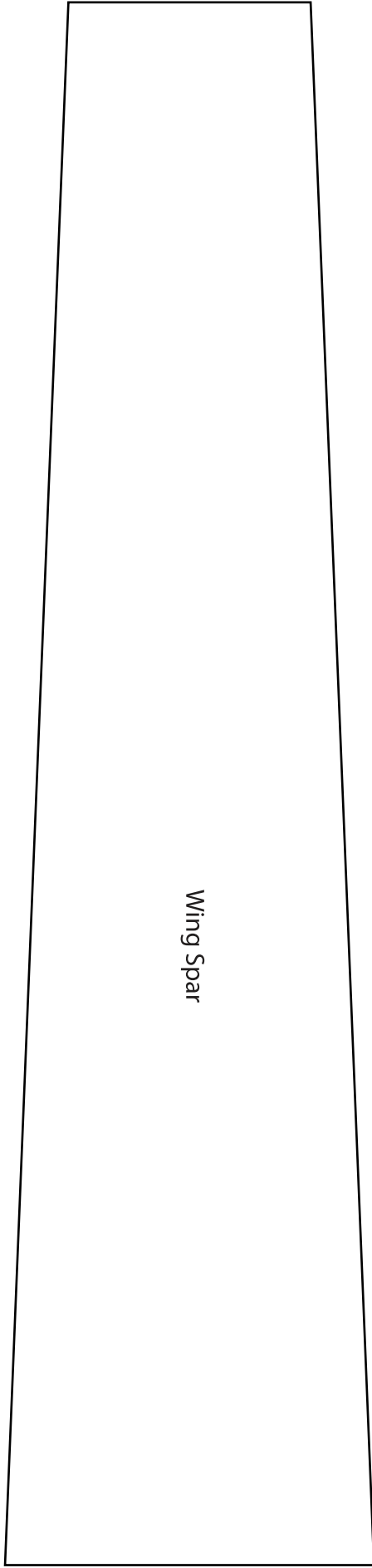
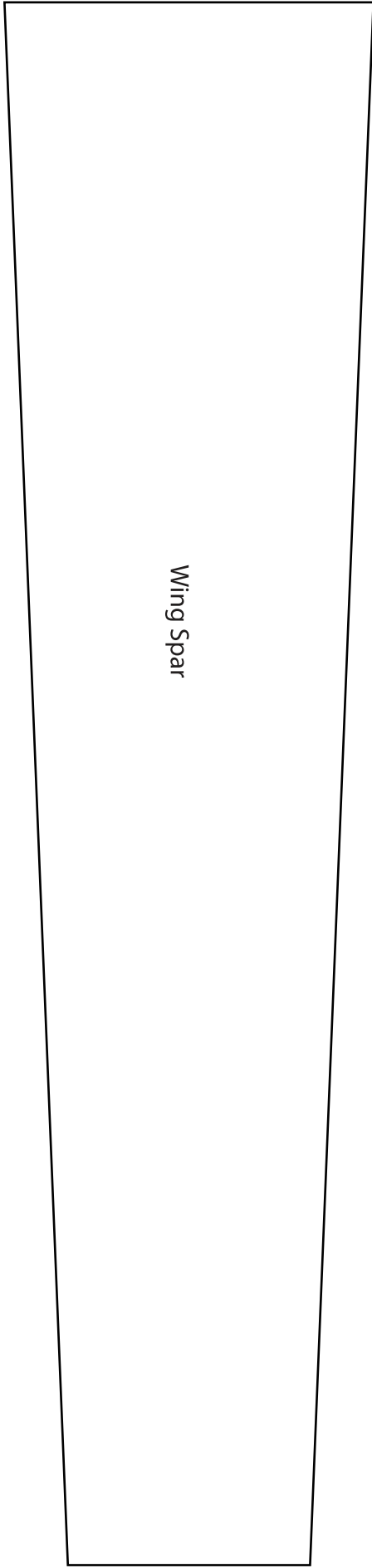

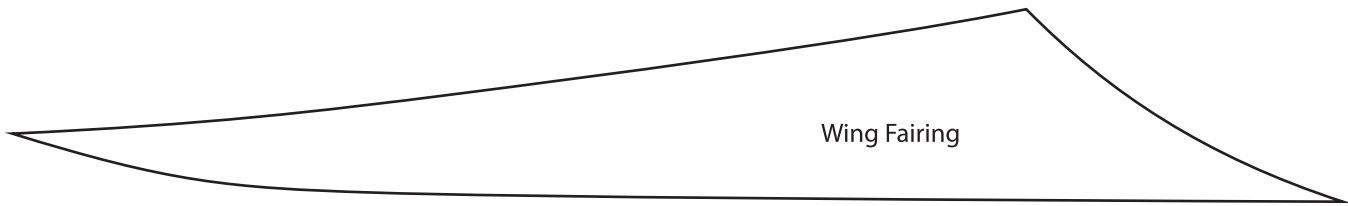

Wing Fairing

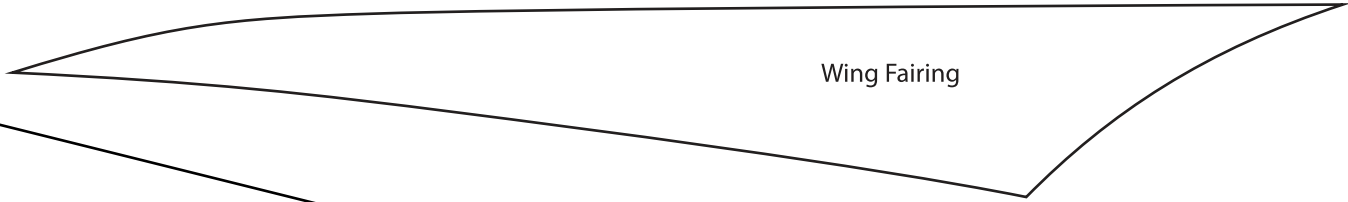

Wing Fairing

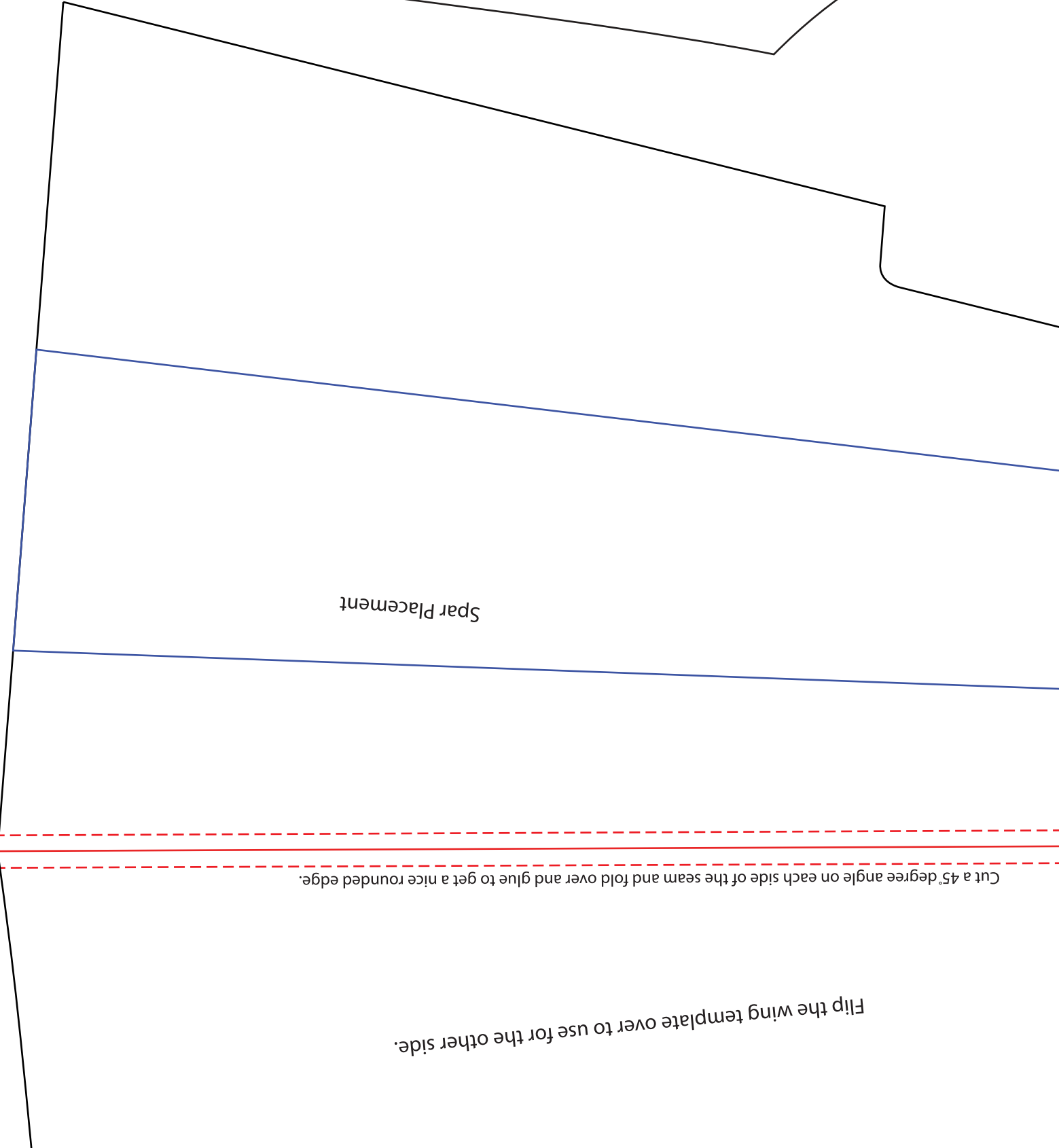

Spar Placement

Flip the wing template over to use for the other side.

Cut a 45° degree angle on each side of the seam and fold over and glue to get a nice rounded edge.

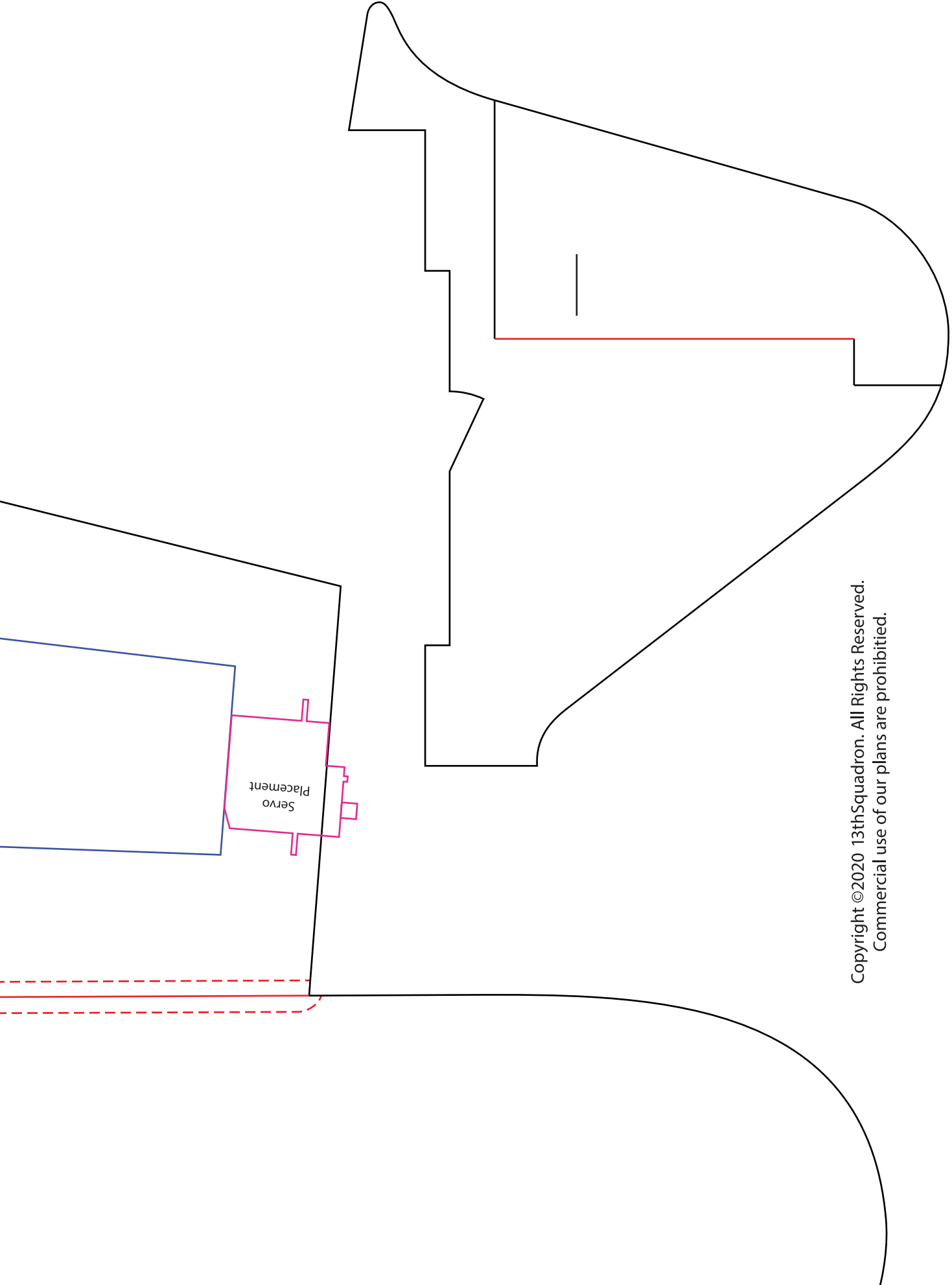

Servo
Placement

Copyright ©2020 13thSquadron. All Rights Reserved.
Commercial use of our plans are prohibited.

A large outline of the number 5 is centered on the page. Inside the outline, there is a dashed line forming a rounded rectangular shape. The text "Cut out after glued in place." is written inside this dashed shape. The number 5 is drawn with a solid black line, and the cutout area is defined by a dashed black line.

5

Cut out after glued in place.

Copyright ©2020 13thSquadron. All Rights Reserved.
Commercial use of our plans are prohibited.



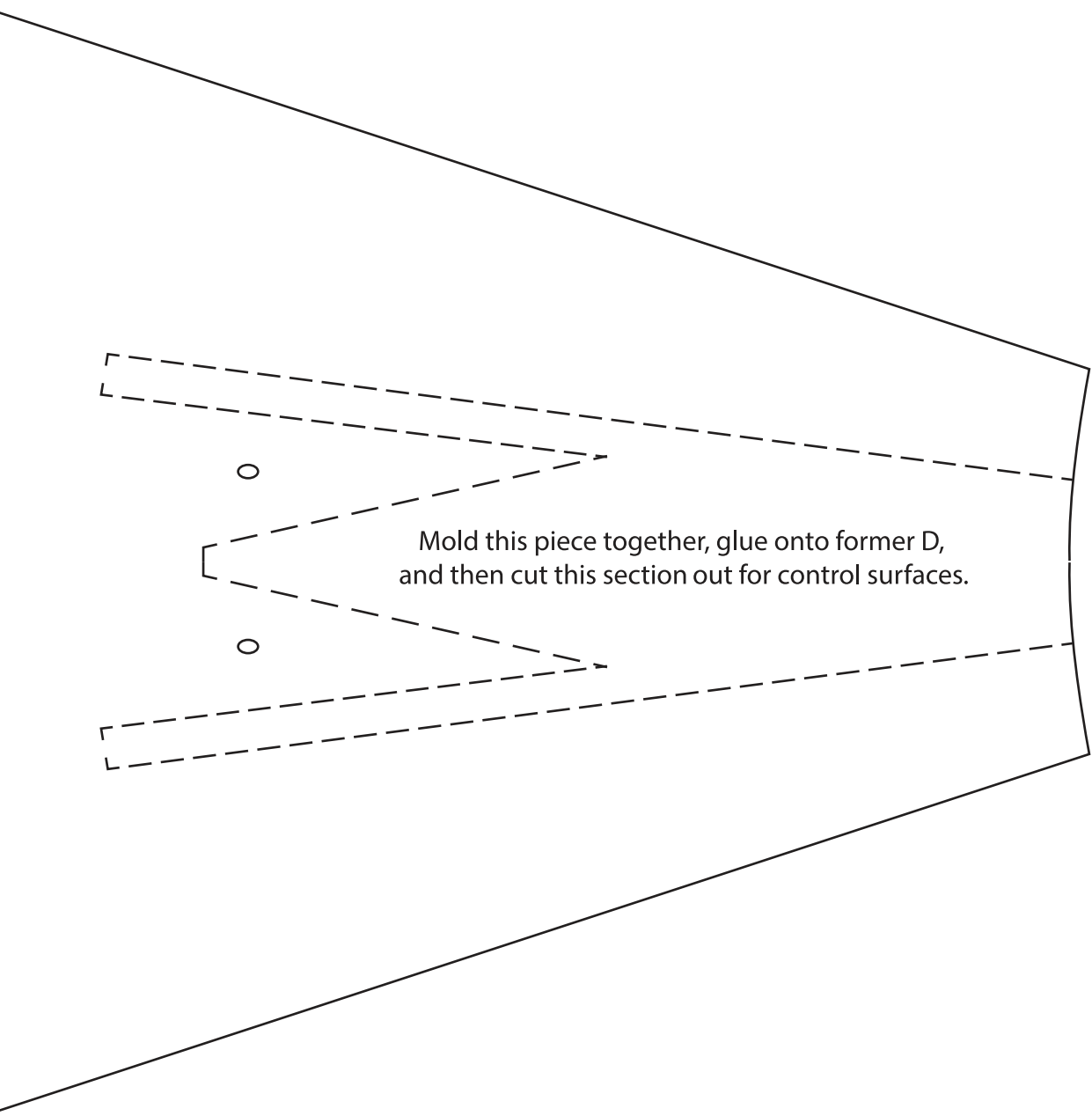

Mold this piece together, glue onto former D,
and then cut this section out for control surfaces.

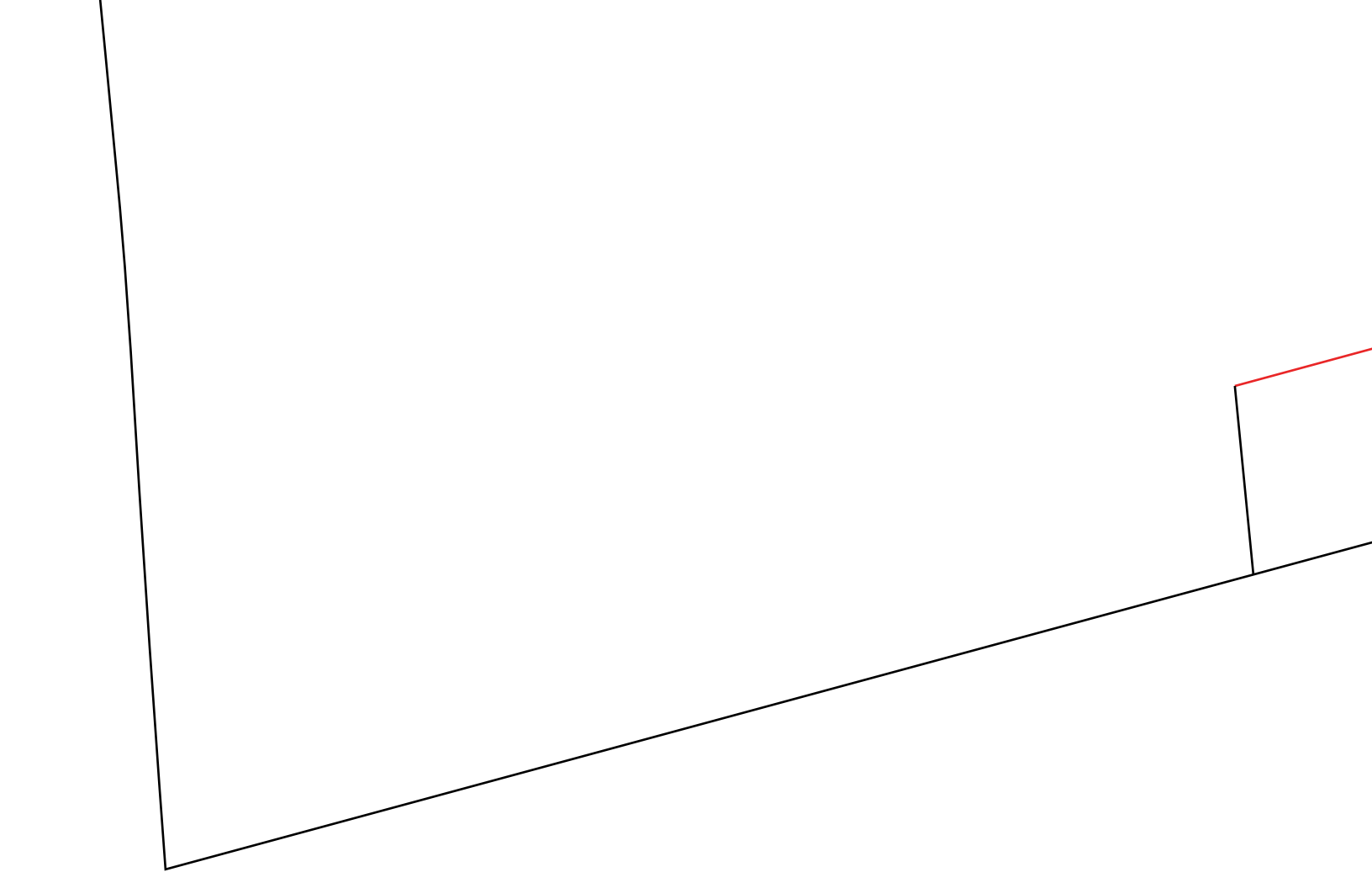

Copyright ©2020 13thSquadron. All Rights Reserved.
Commercial use of our plans are prohibited.

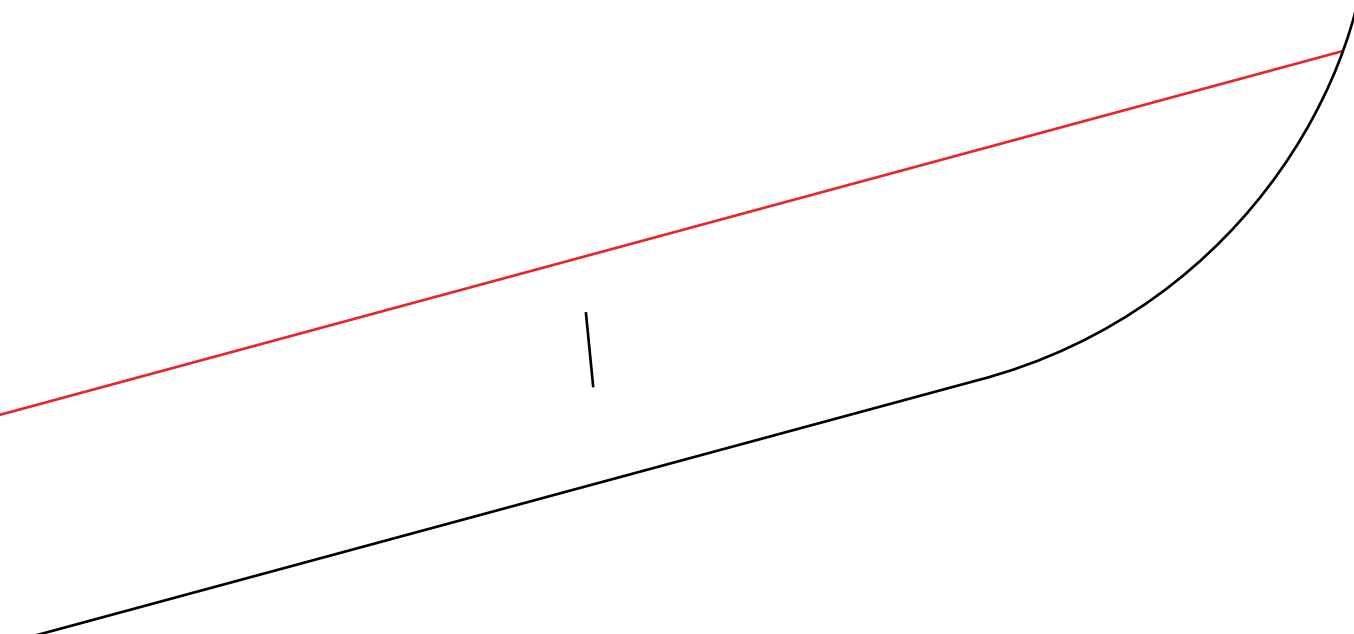

How to glue the leading edges of the wings.

1.

Bevel the inside leading edge of each wing and place blue tape on the outside leading edge.

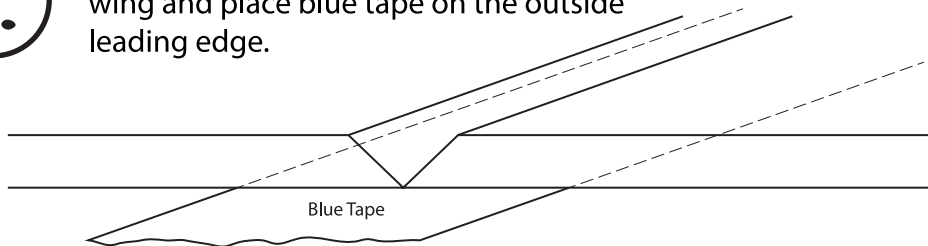

2.

Apply hot glue into the seam.

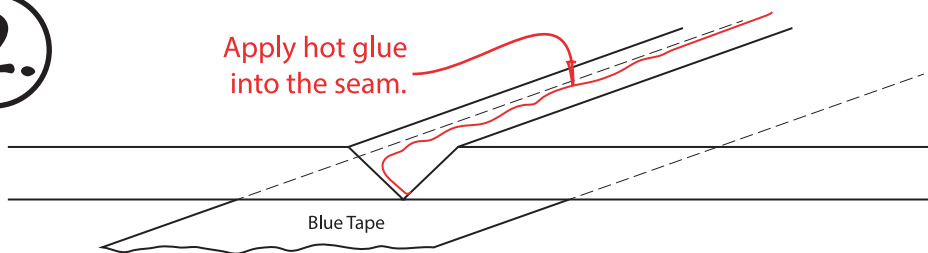

3.

Fold Foaboard over to create the airfoil and create a nice rounded front edge.

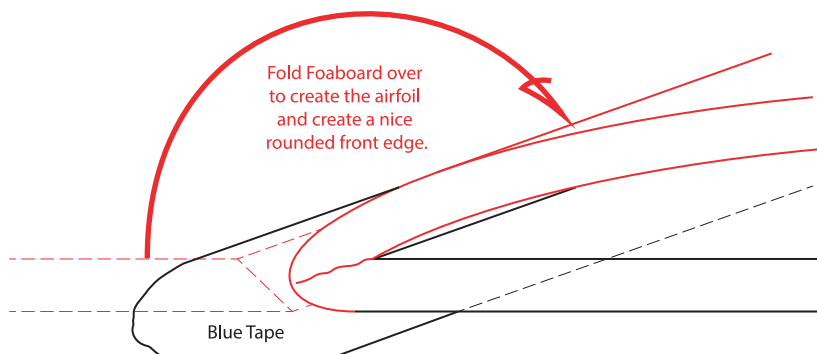

Copyright ©2020 13thSquadron. All Rights Reserved.
Commercial use of our plans are prohibited.

