

19 11/16"

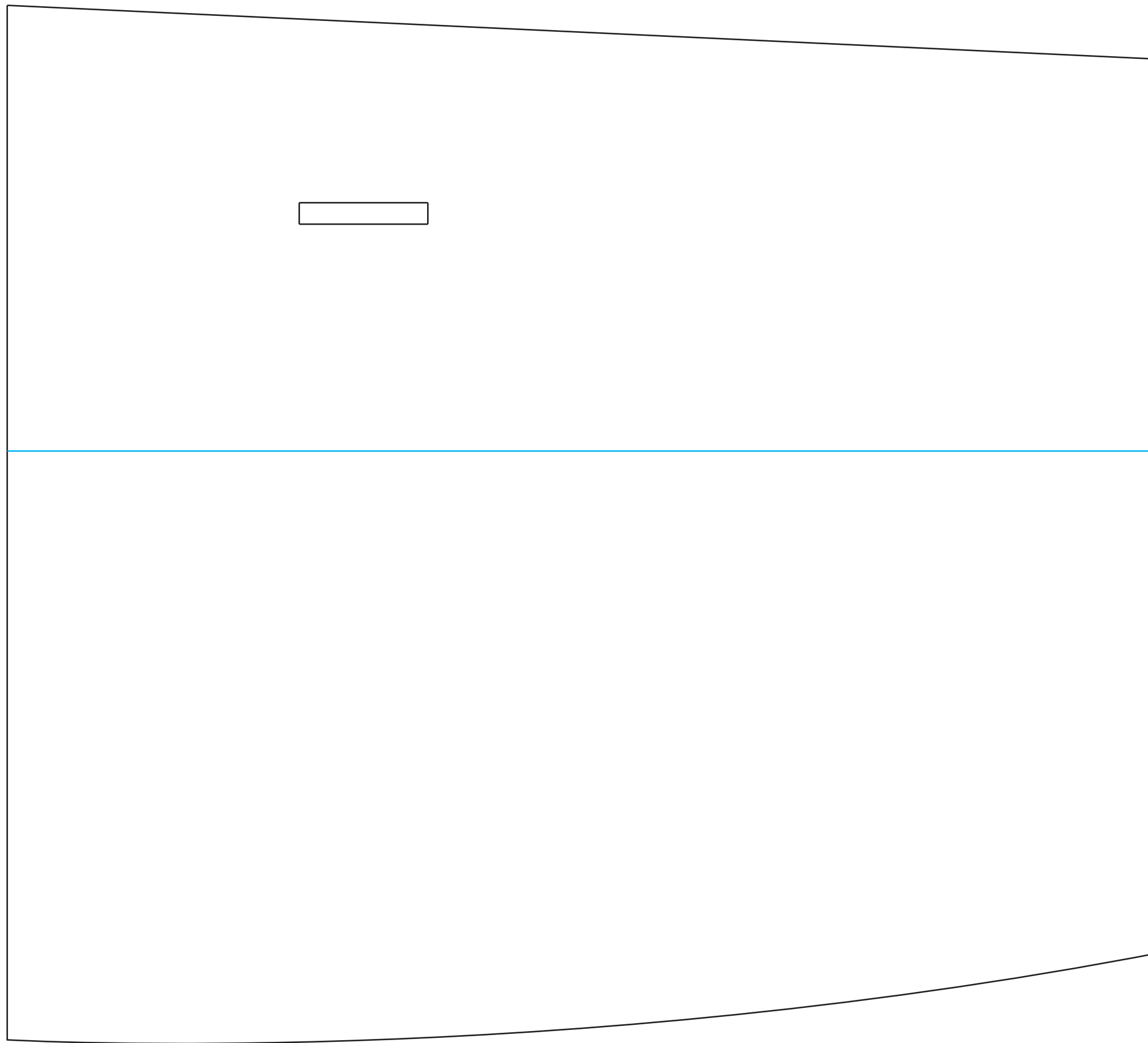

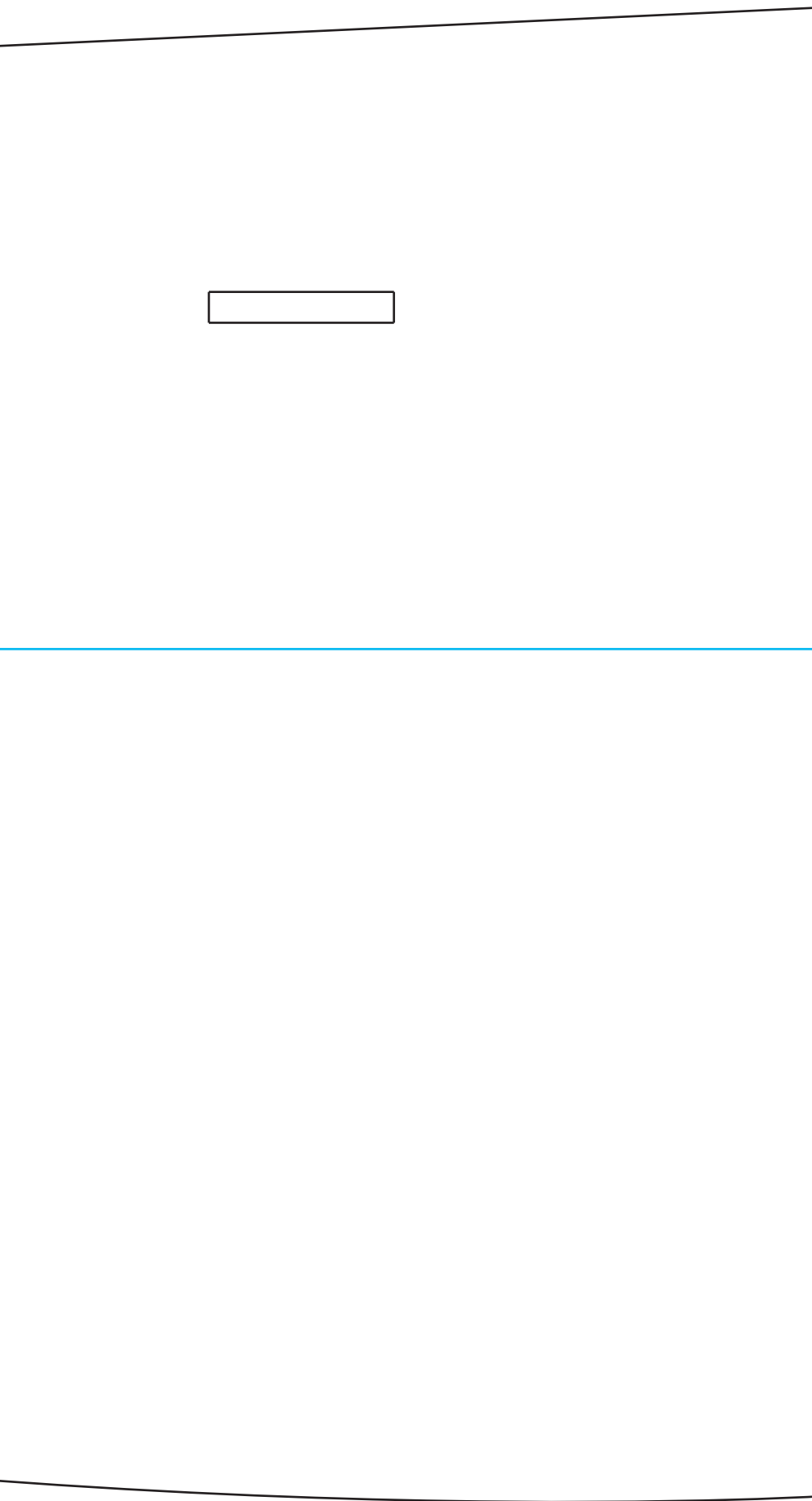

Copyright ©2020 13thSquadron. All Rights Reserved.
Commercial use of our plans are prohibited.

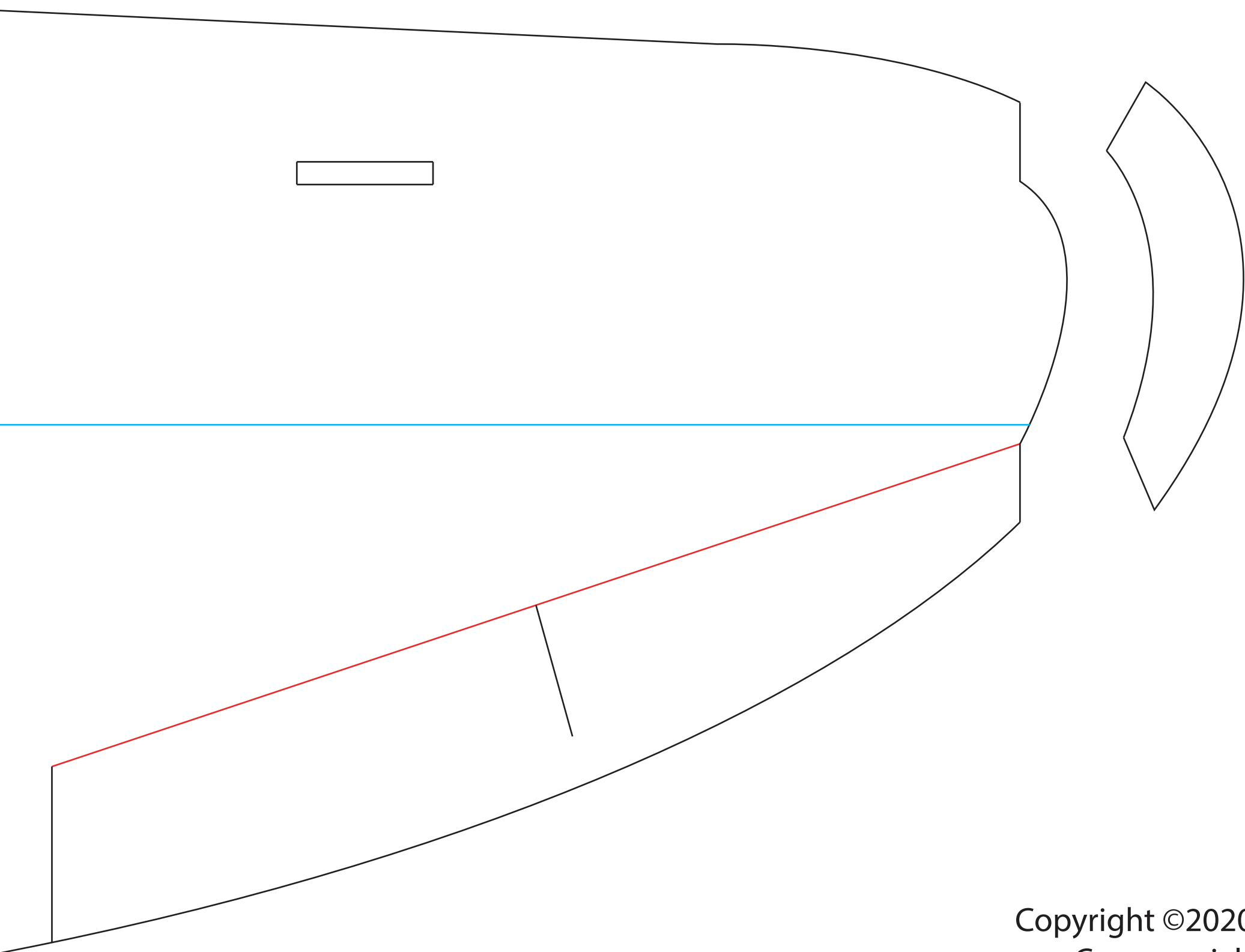
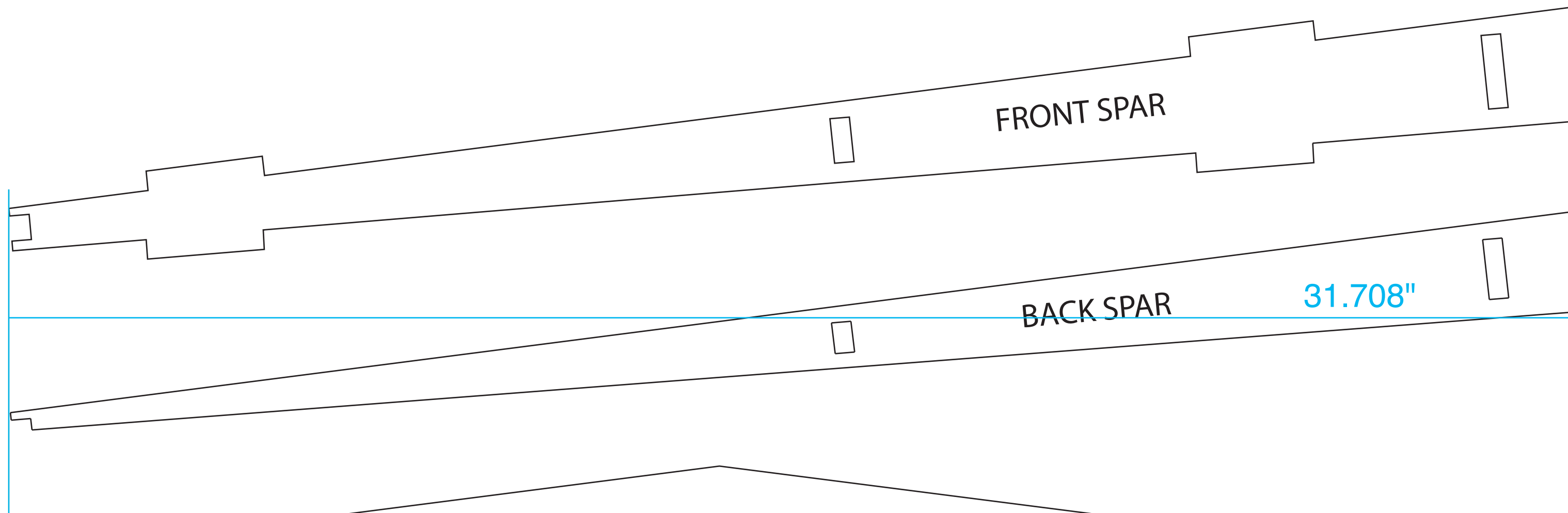

FRONT SPAR

BACK SPAR

31.708"

FRONT SPAR

BACK SPAR

These are made from 1/8" Hobby plywood and glued to each spar for strength.

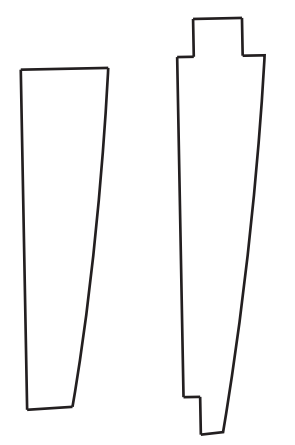
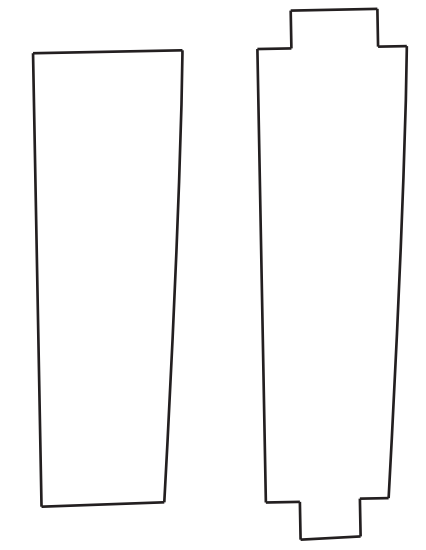
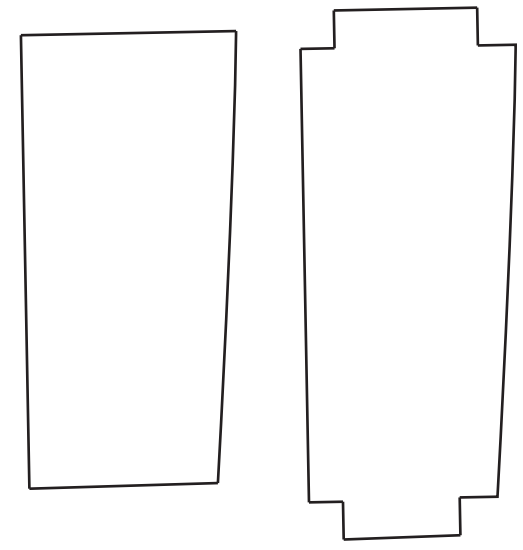
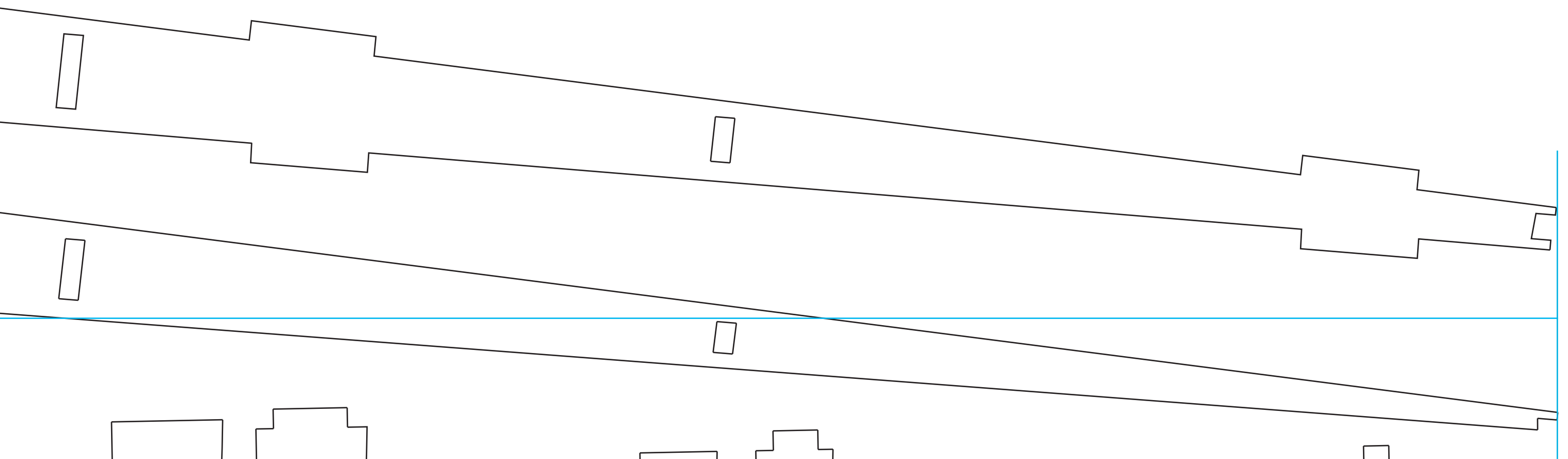

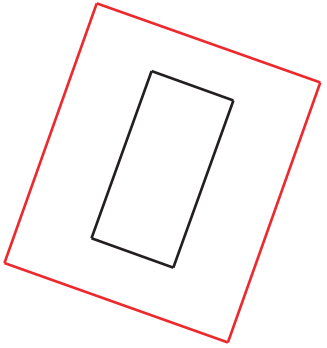

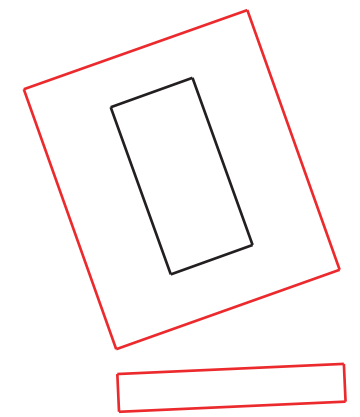
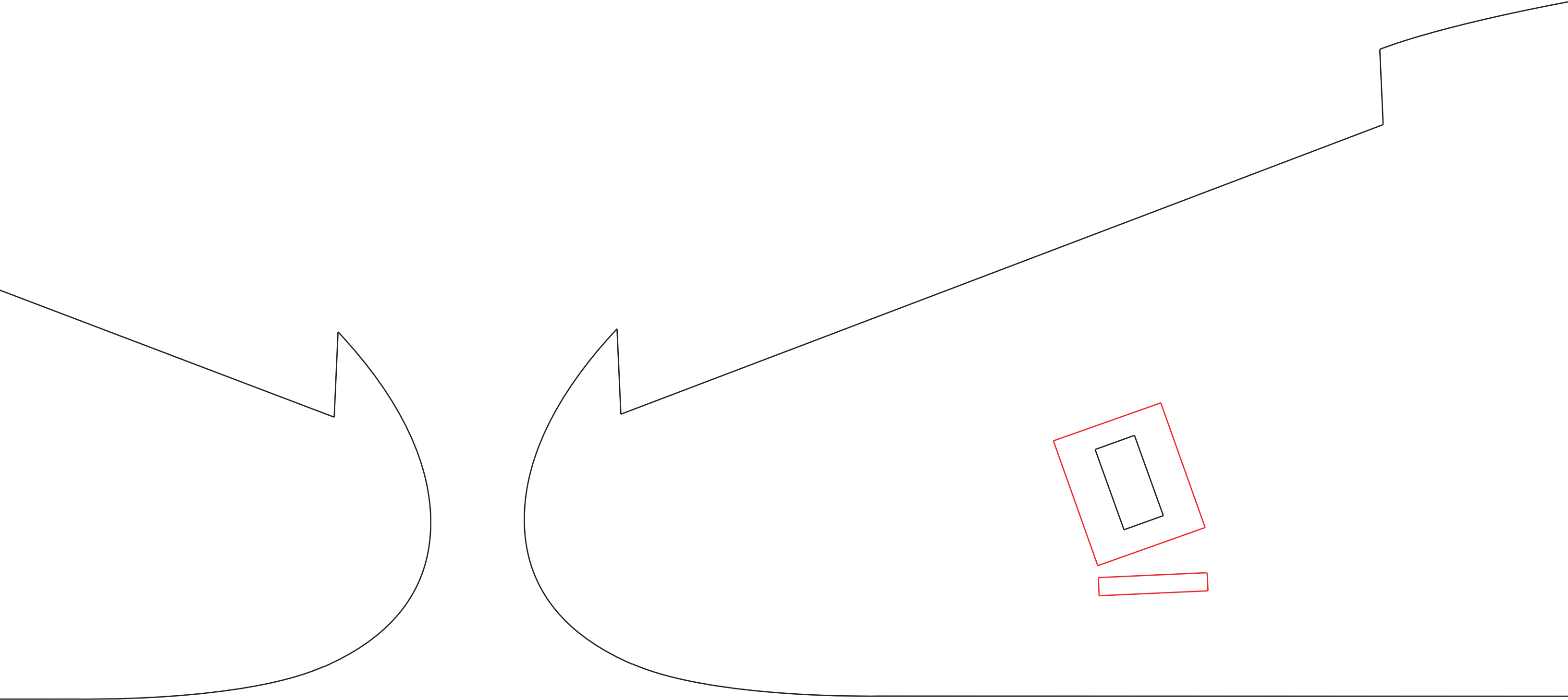

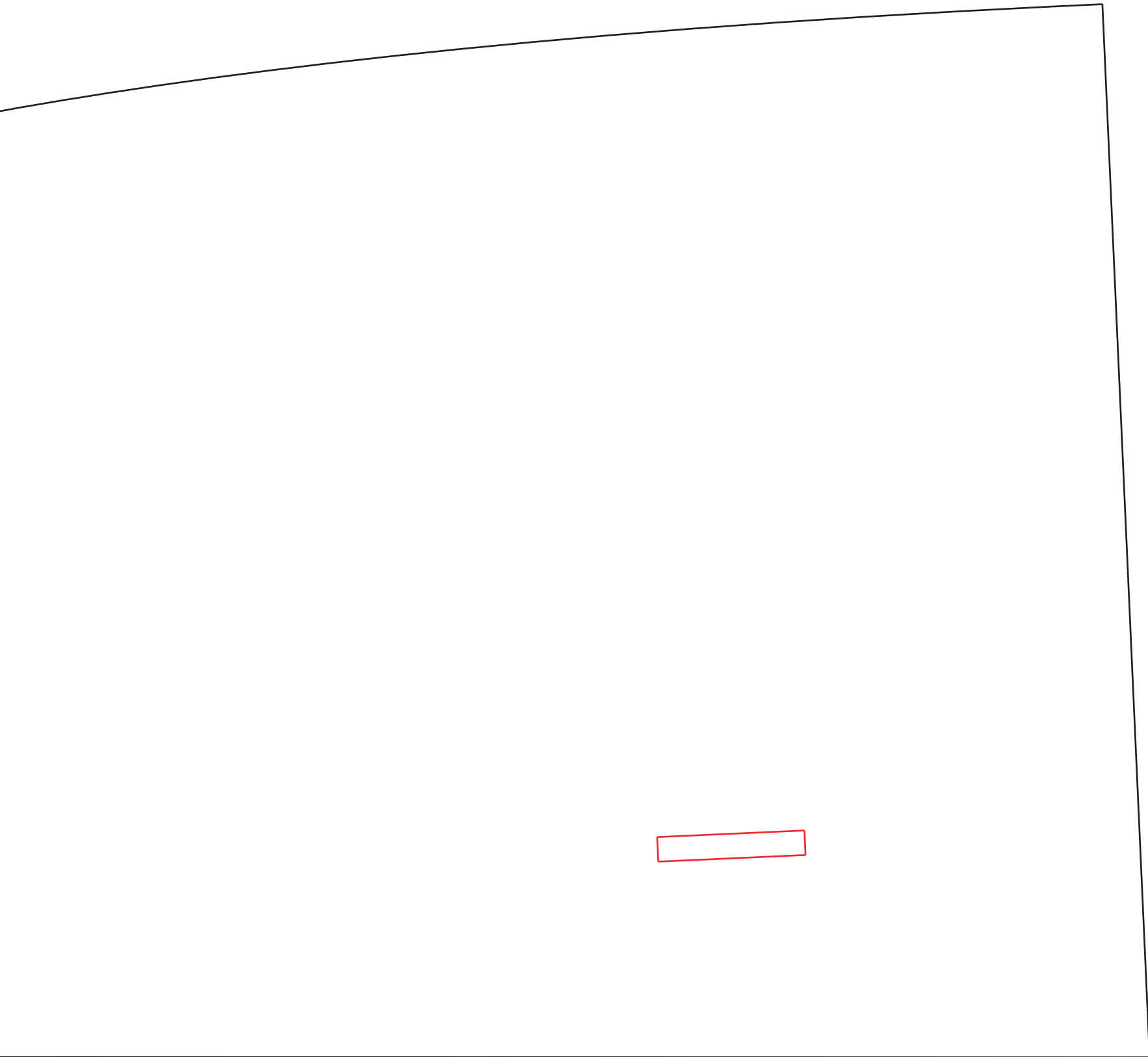

This piece is used on the hatch for structural support and is glued in the center of the hatch.

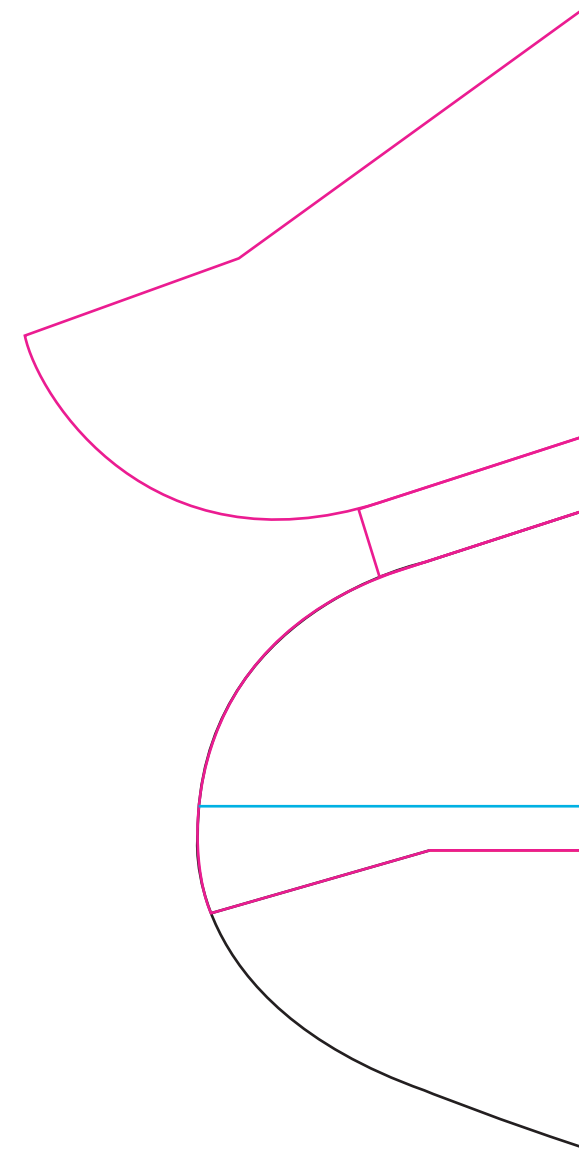
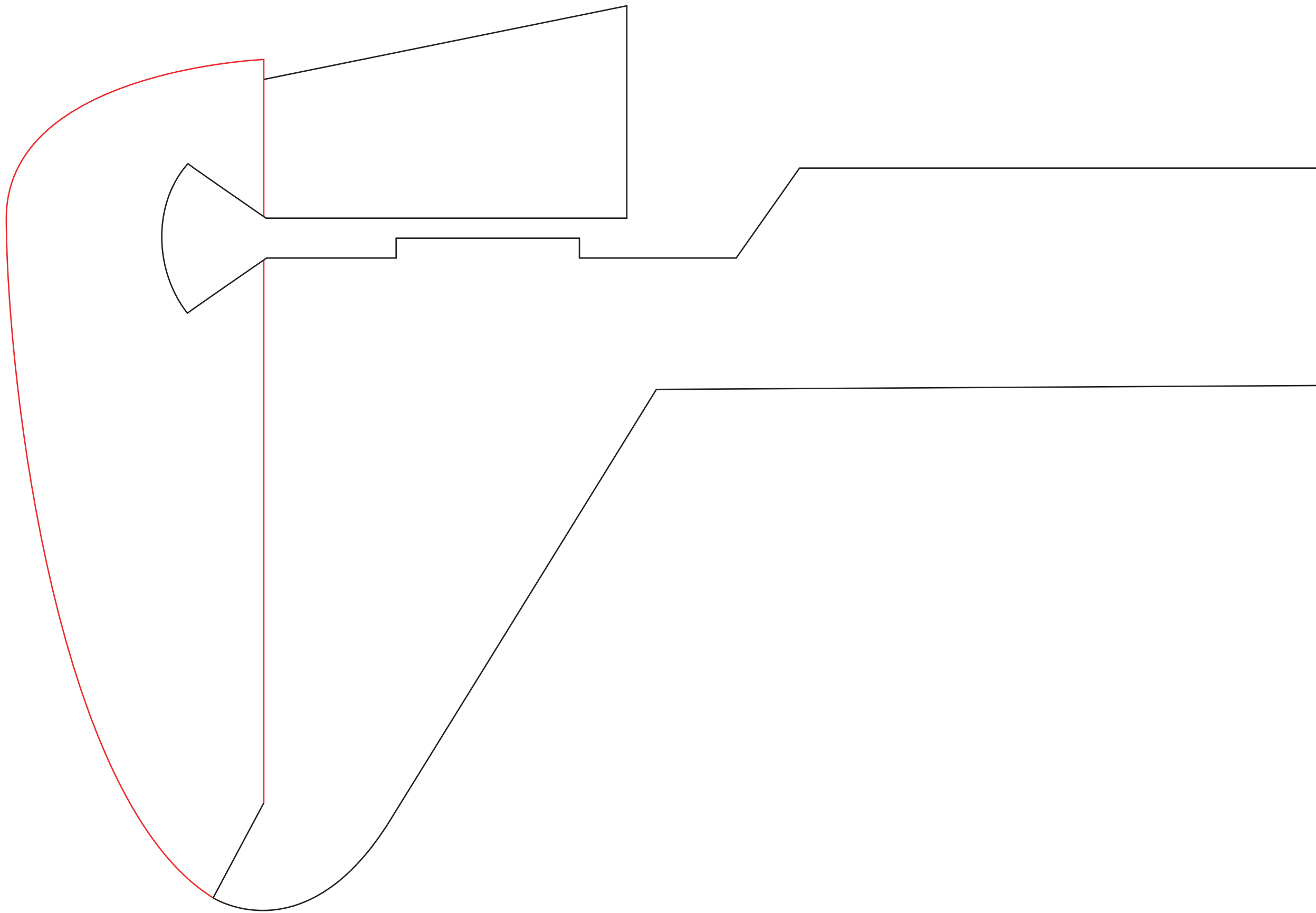

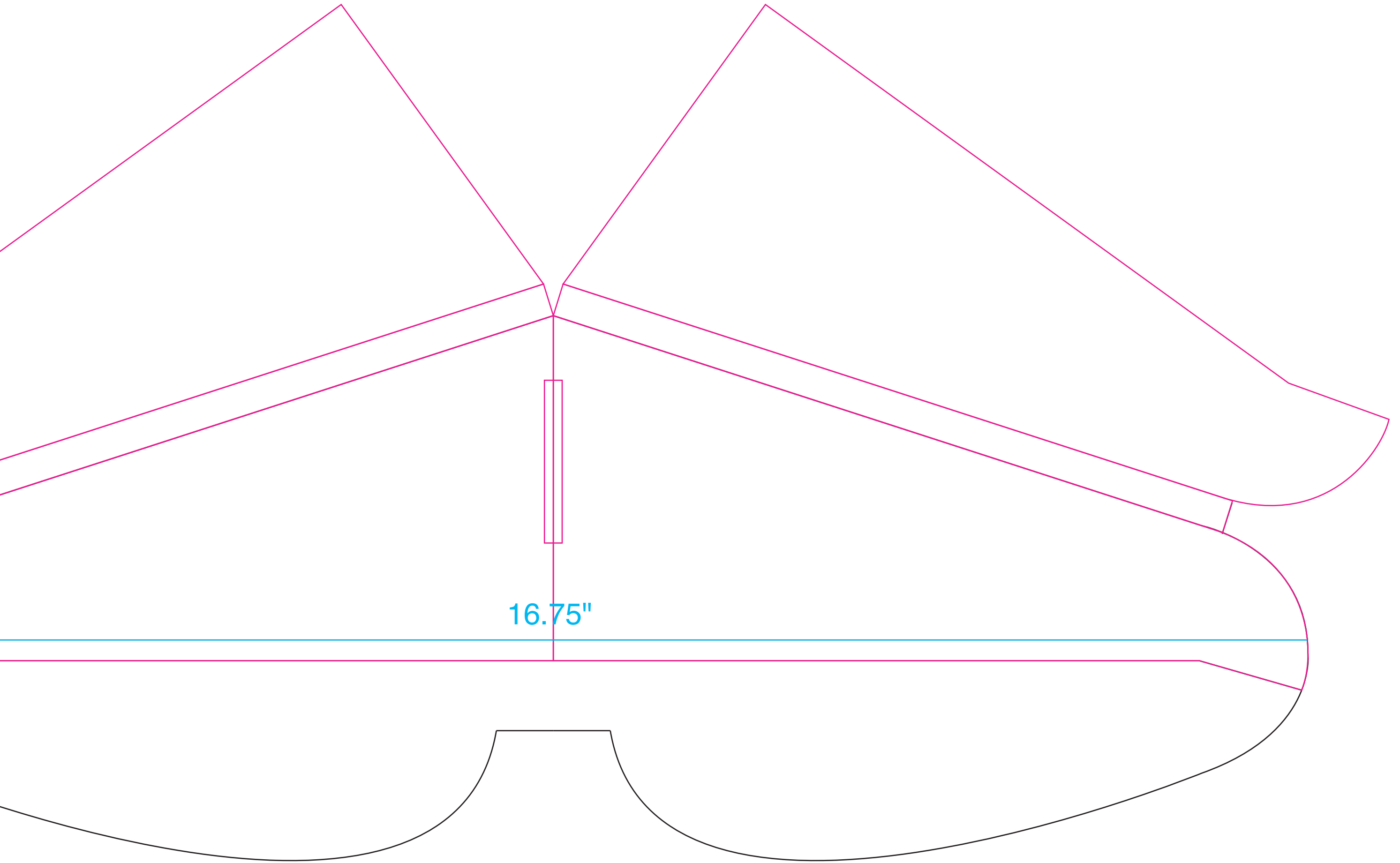

16.75"

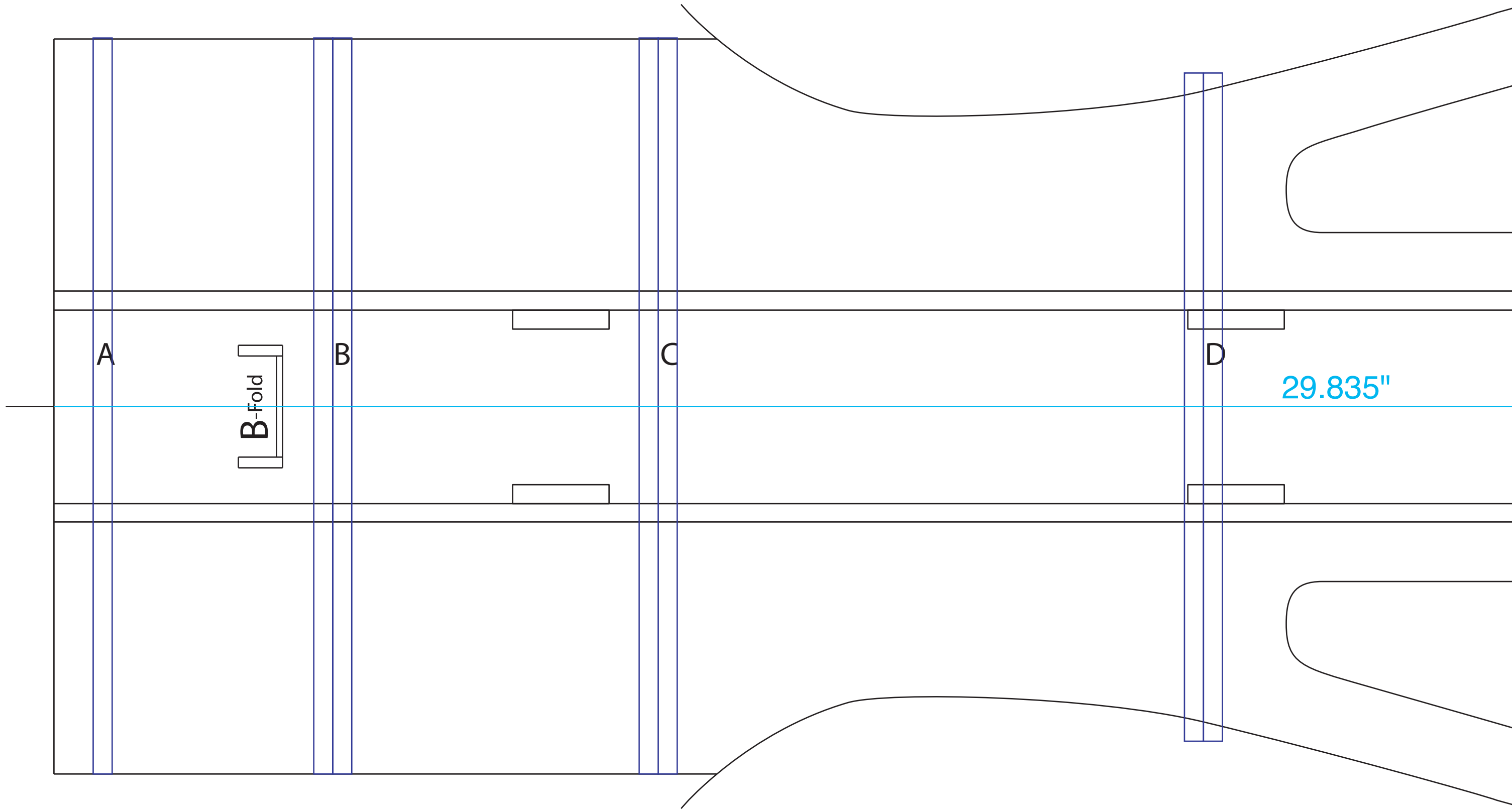

A

B-Fold

B

C

D

29.835"

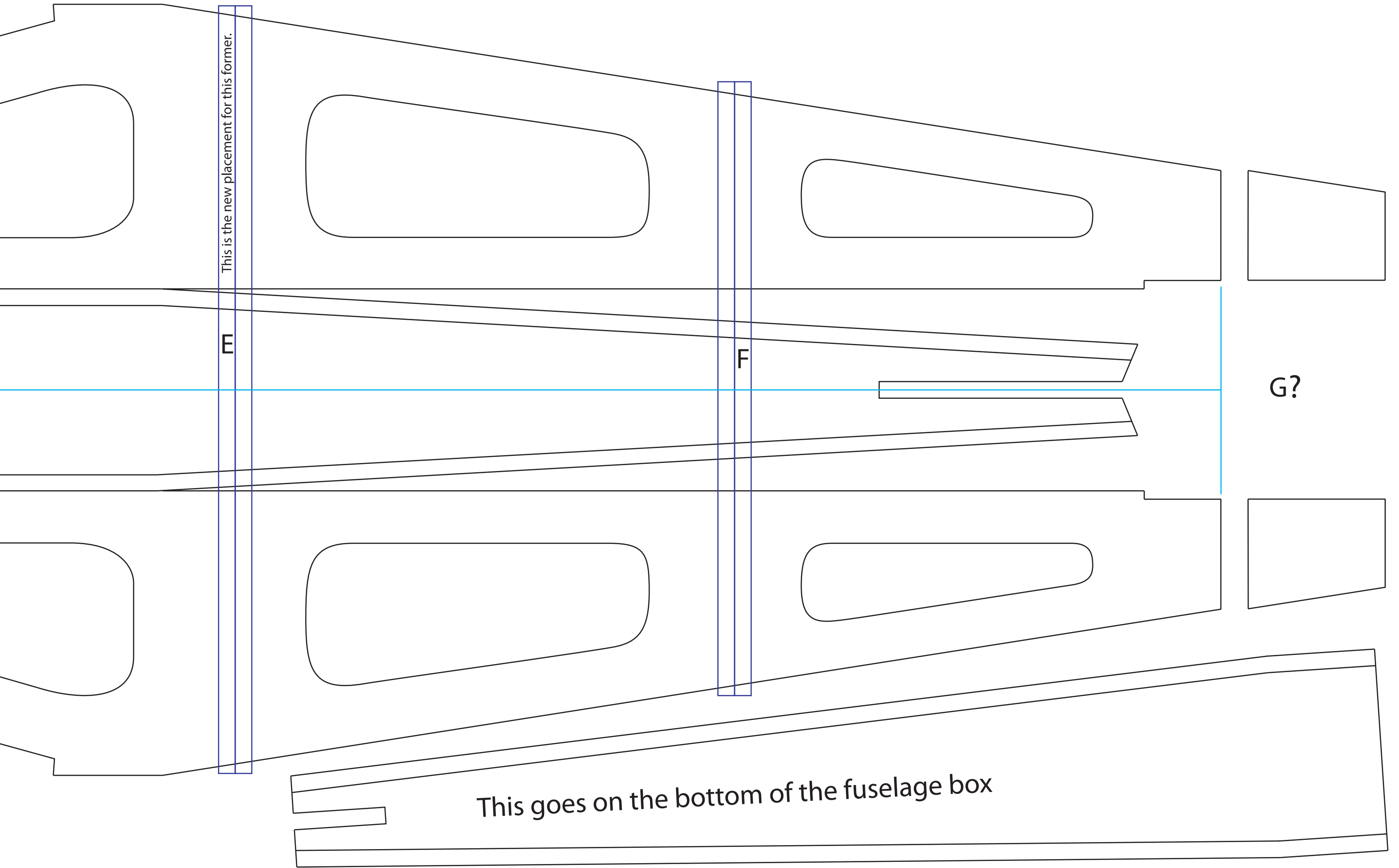

This is the new placement for this former.

F

F

G?

This goes on the bottom of the fuselage box

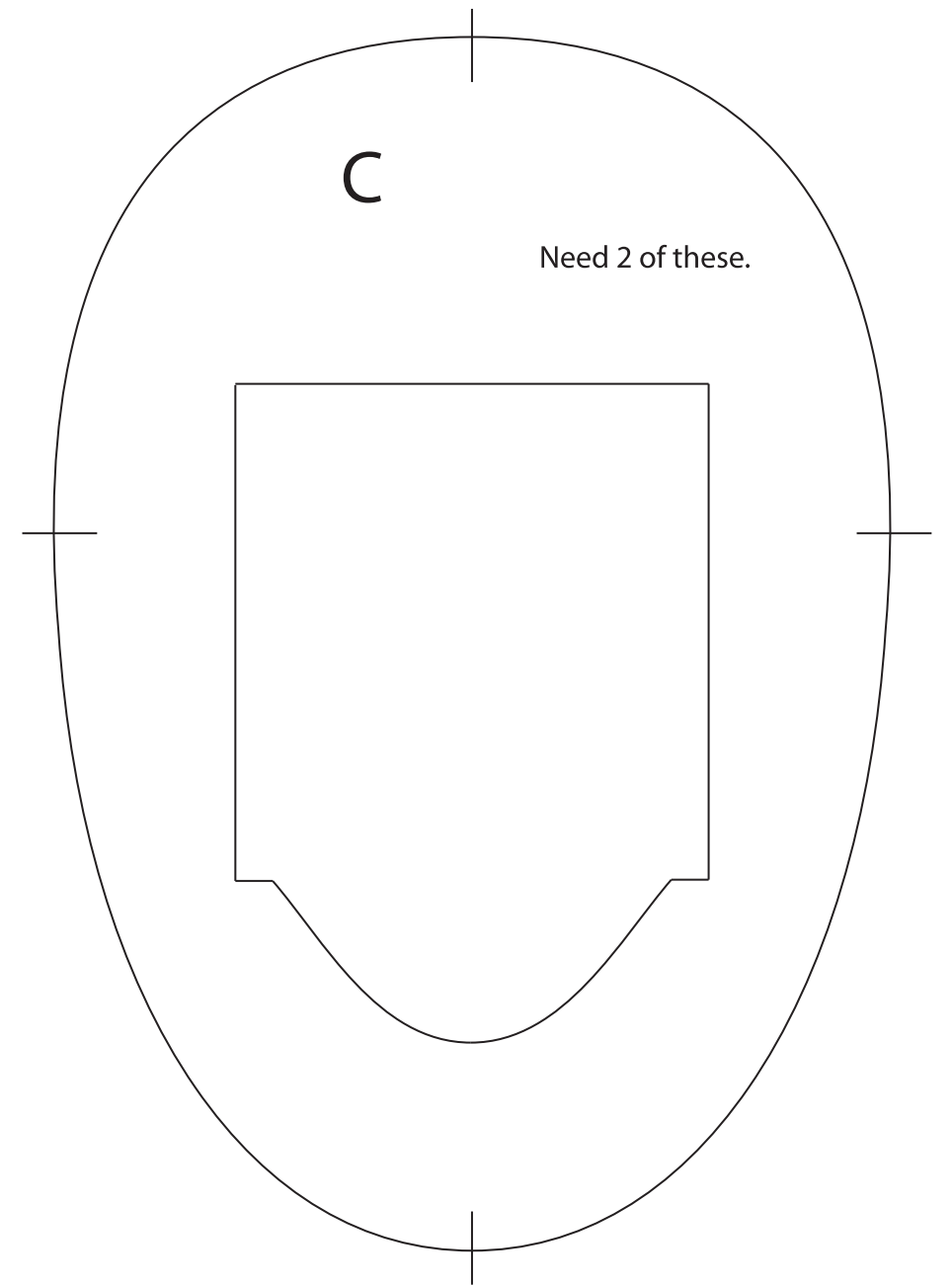
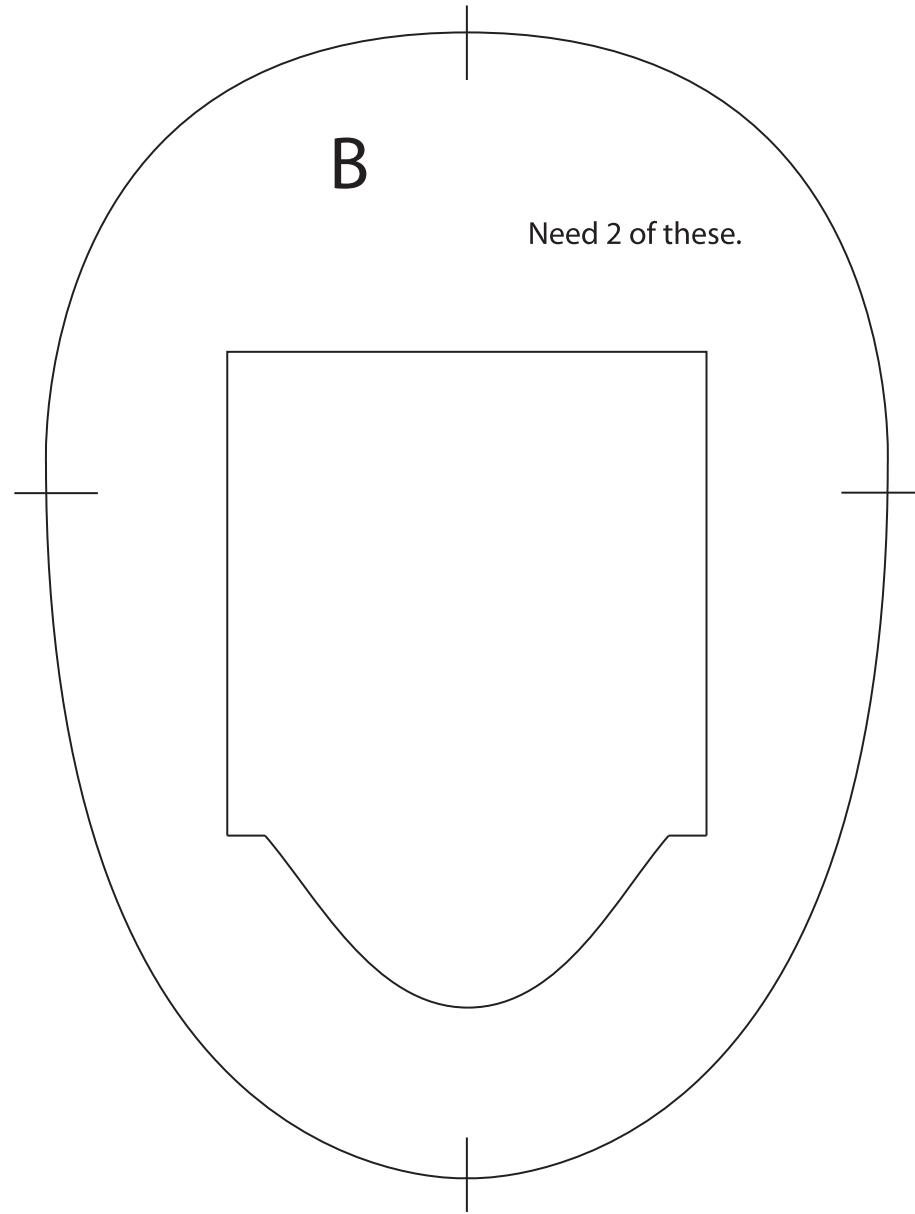
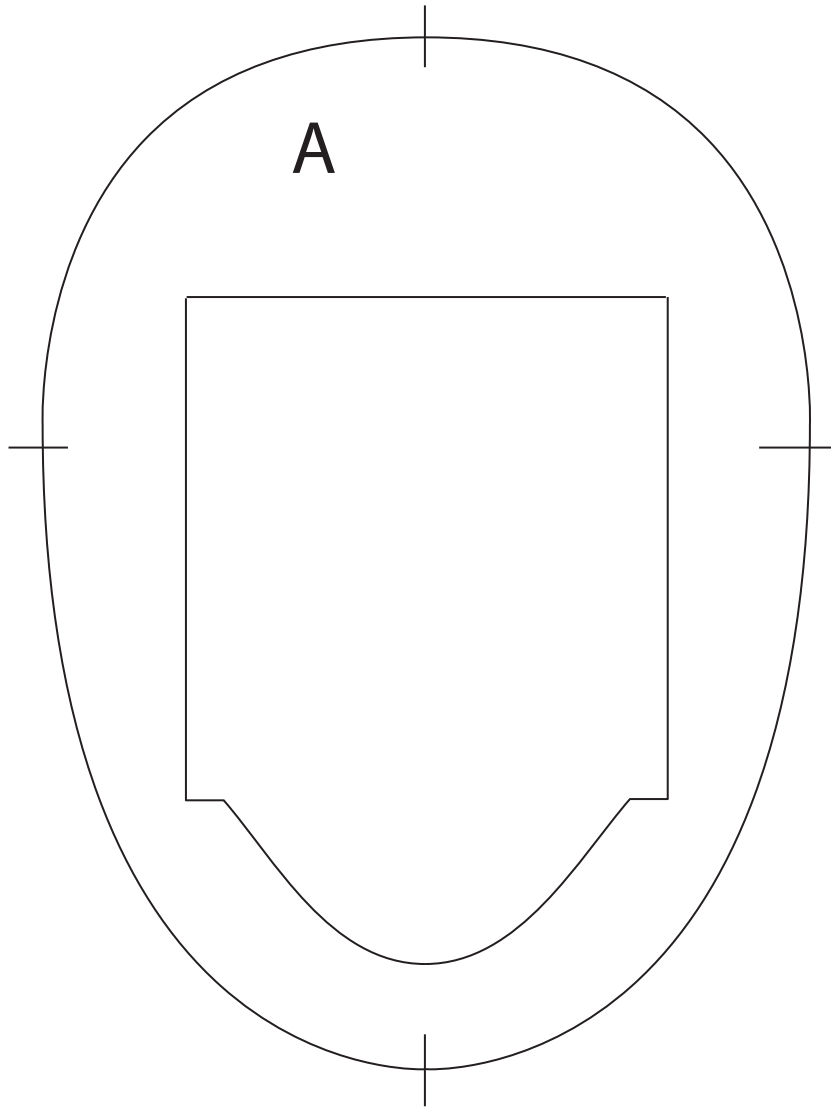

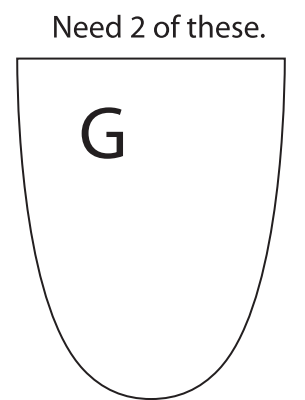
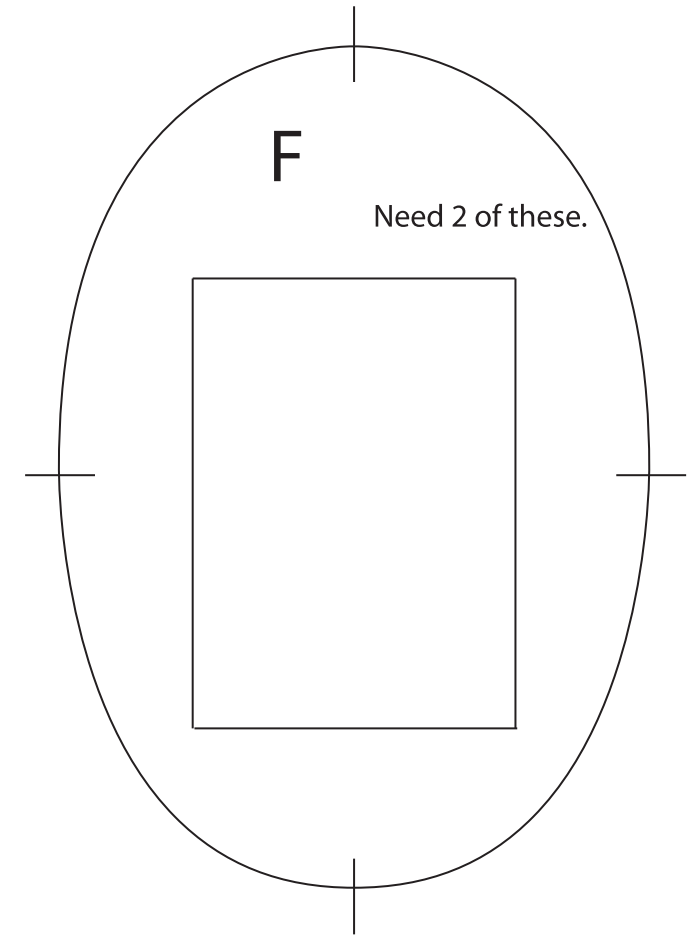
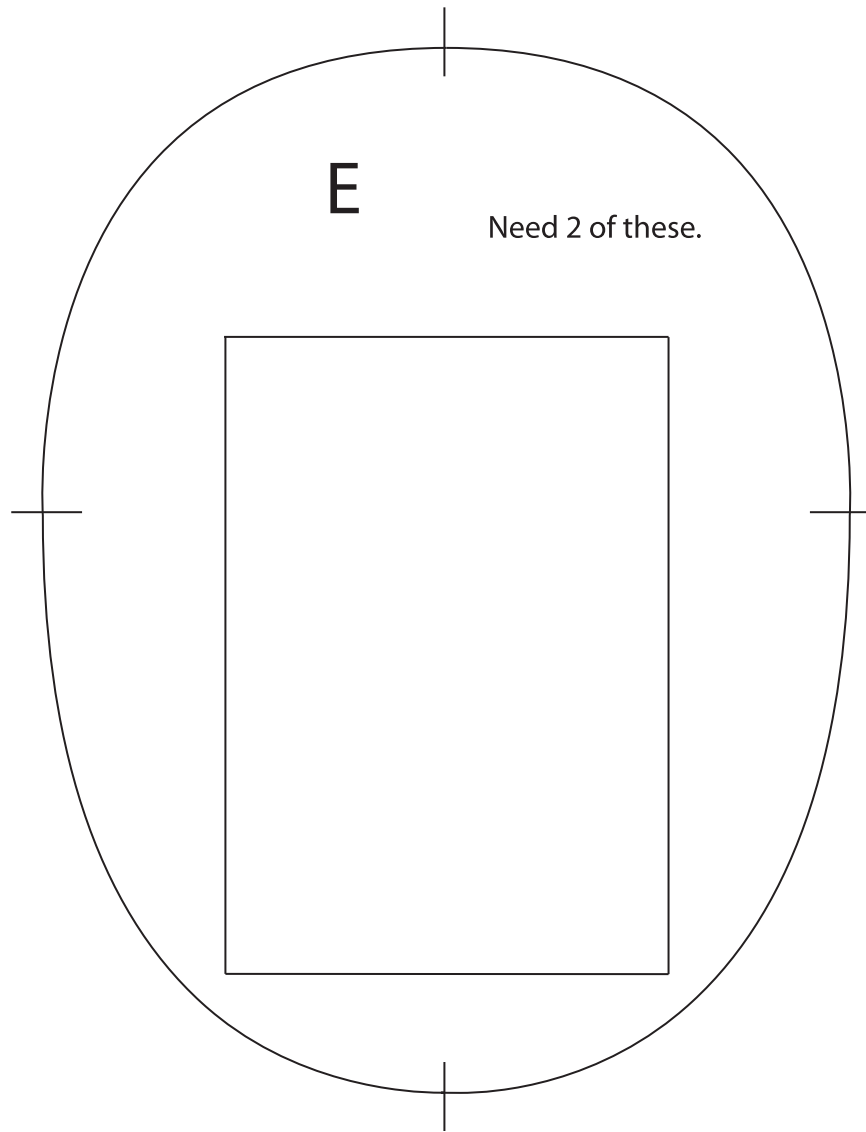
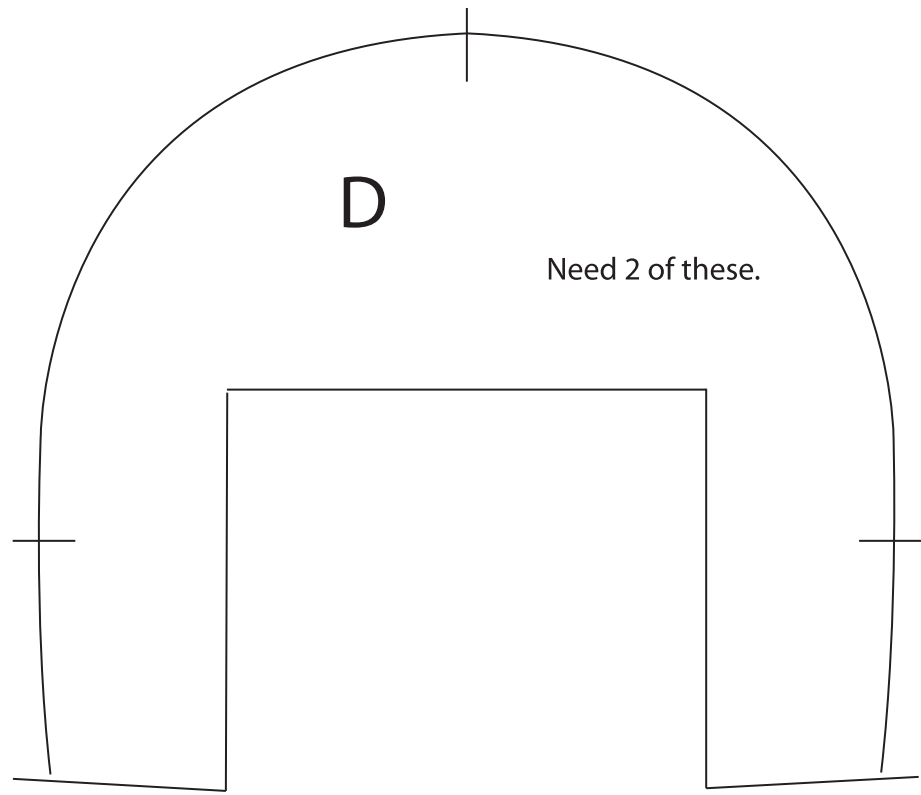

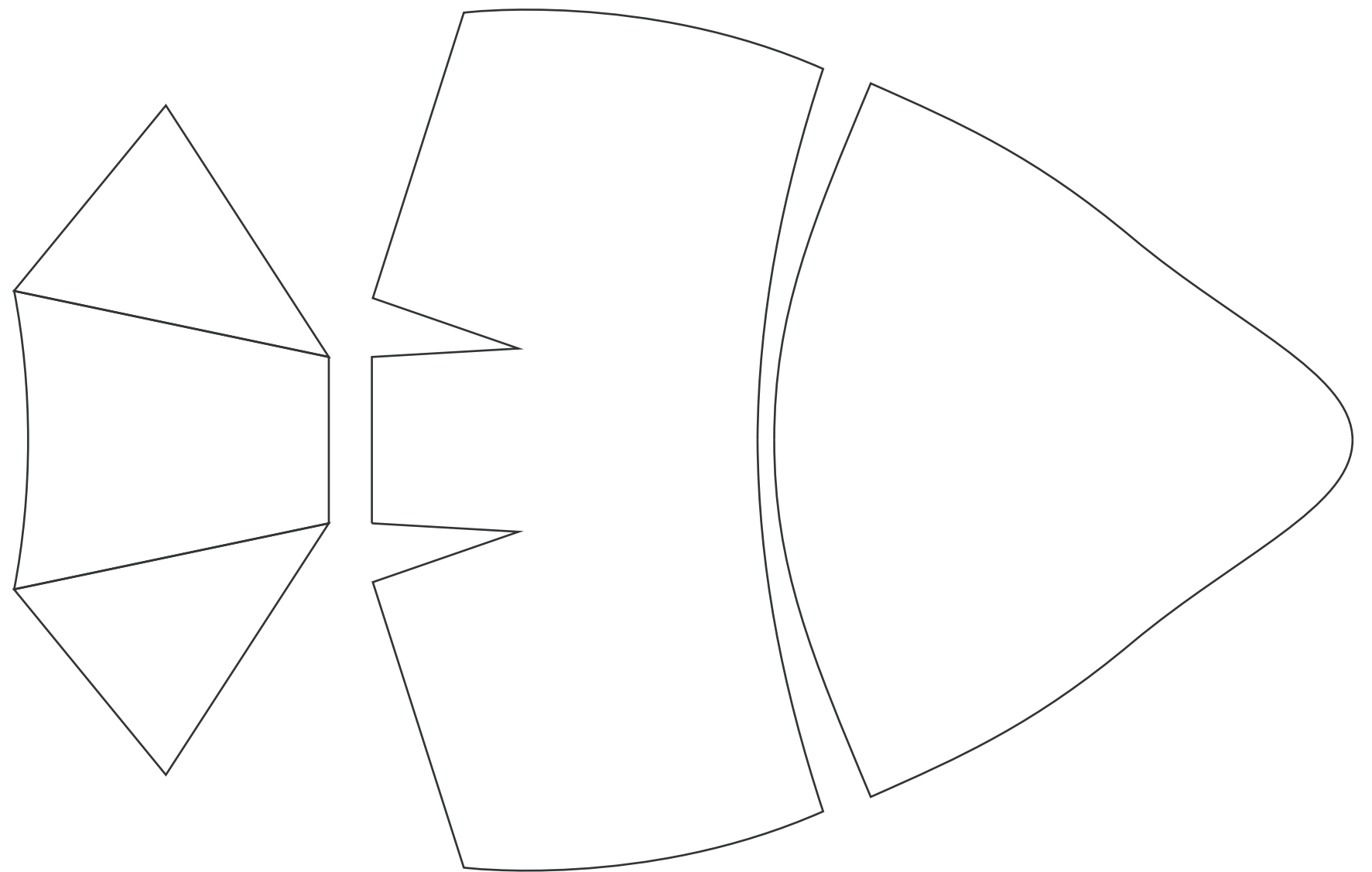
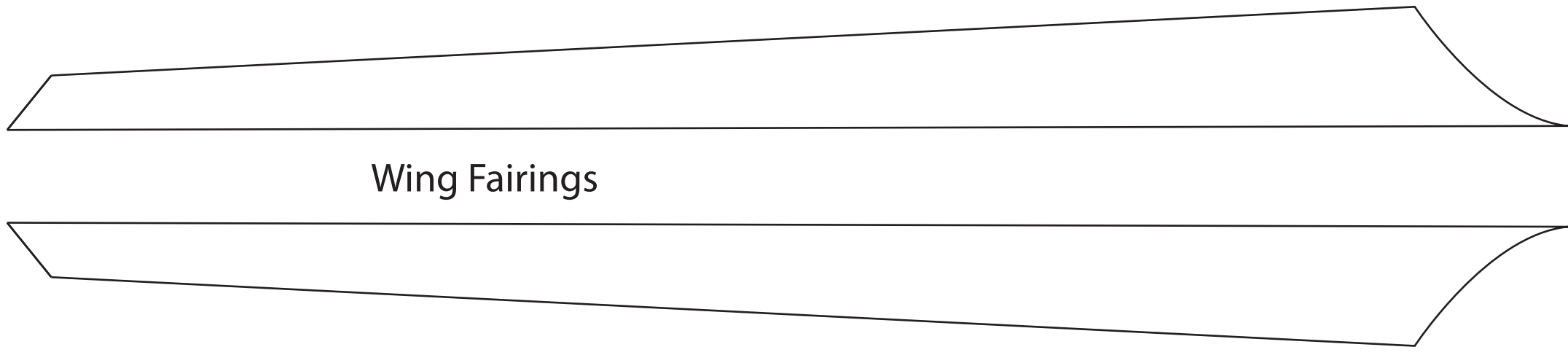

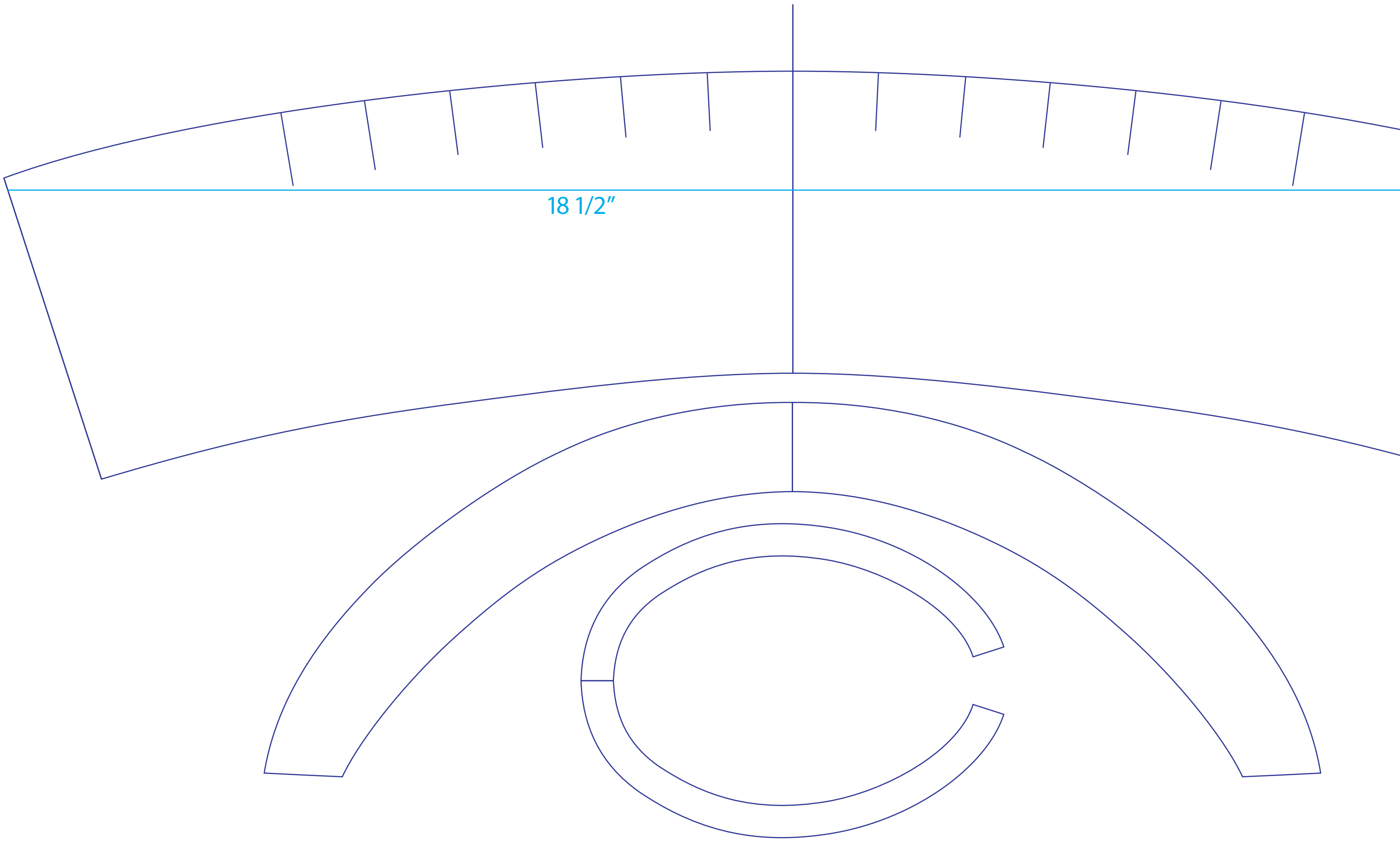

$18 \frac{1}{2}''$

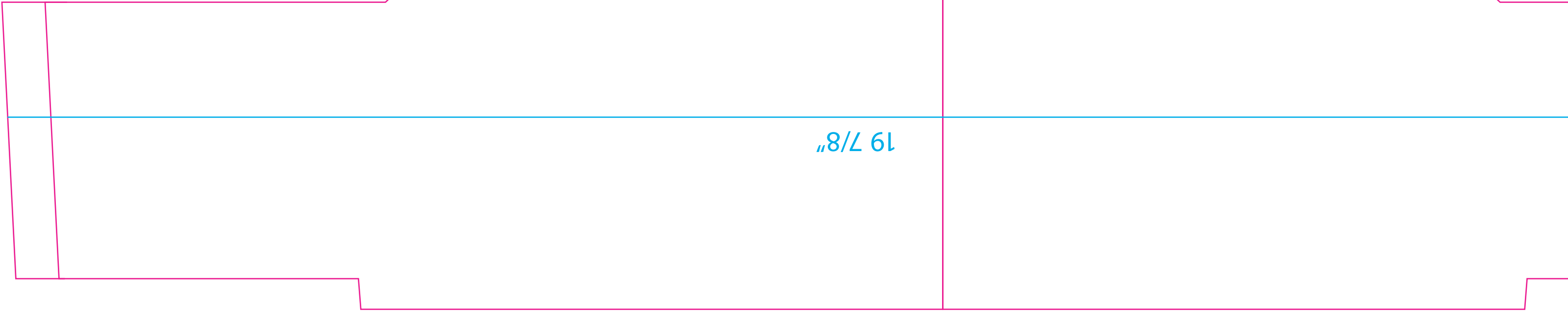
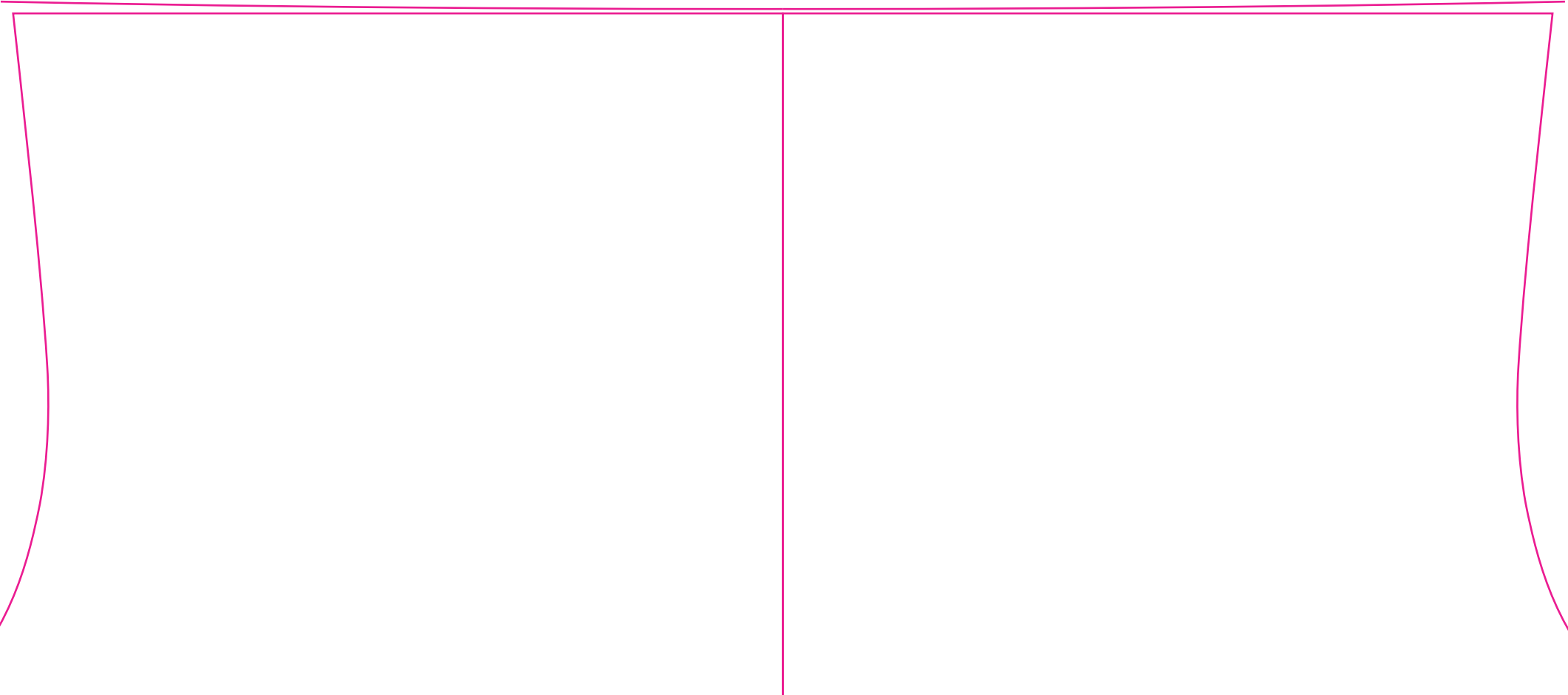
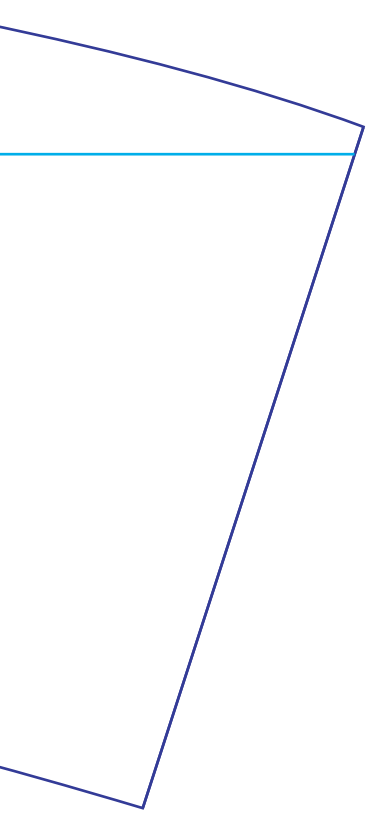

19 7/8"

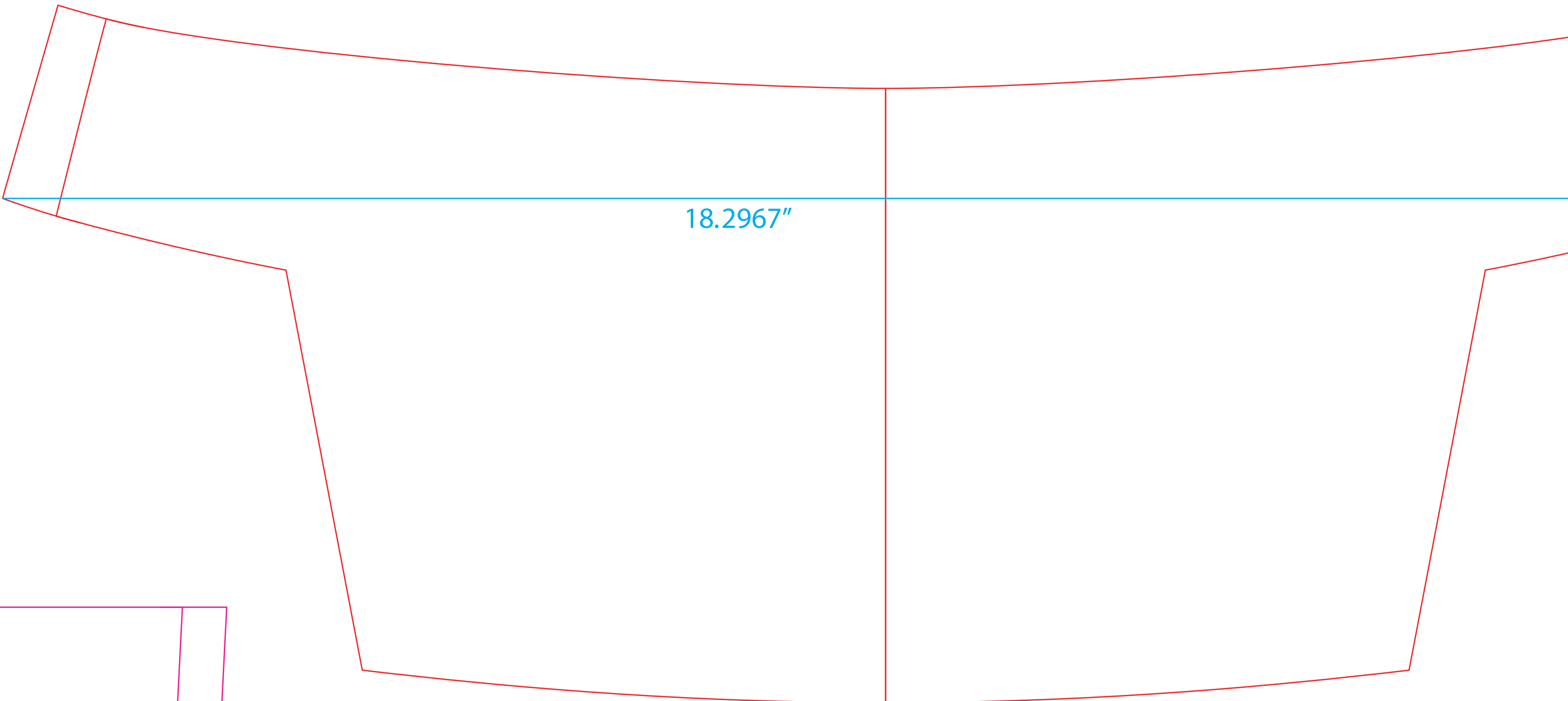

18.2967"

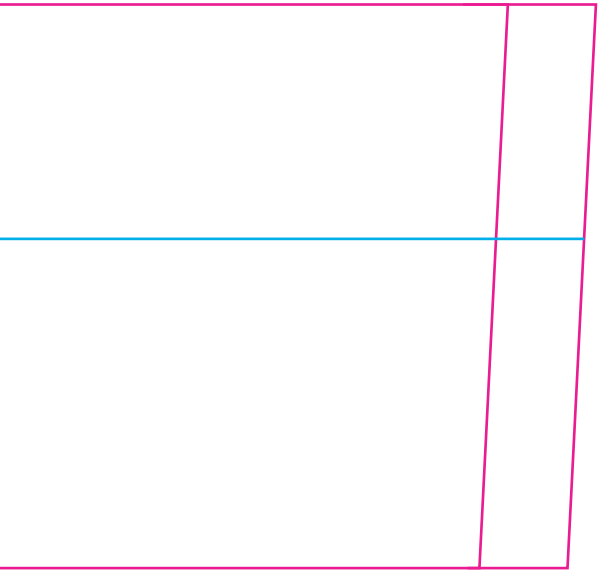

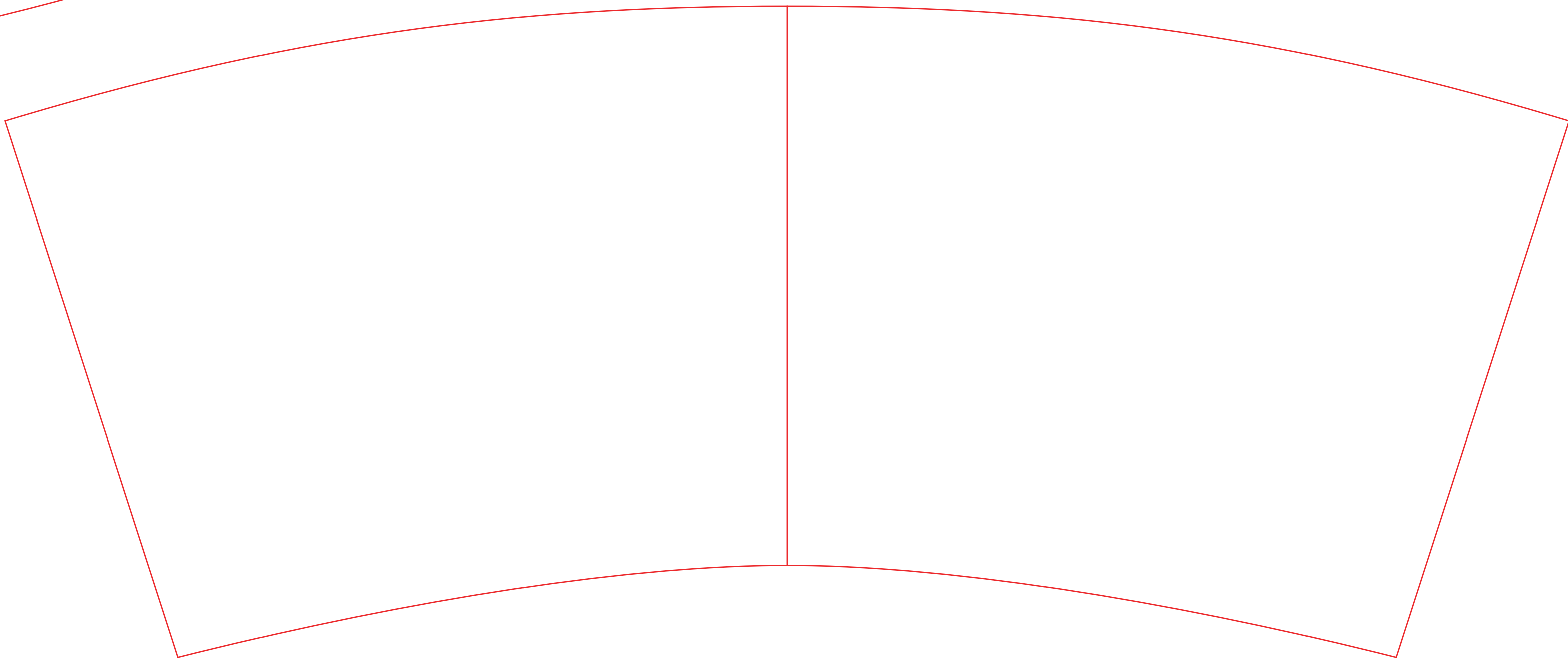
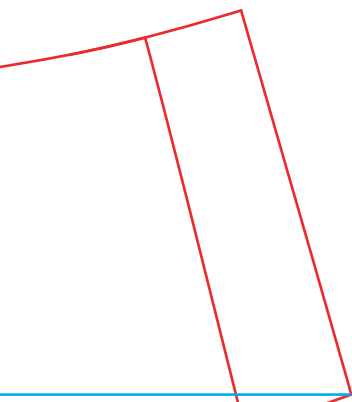

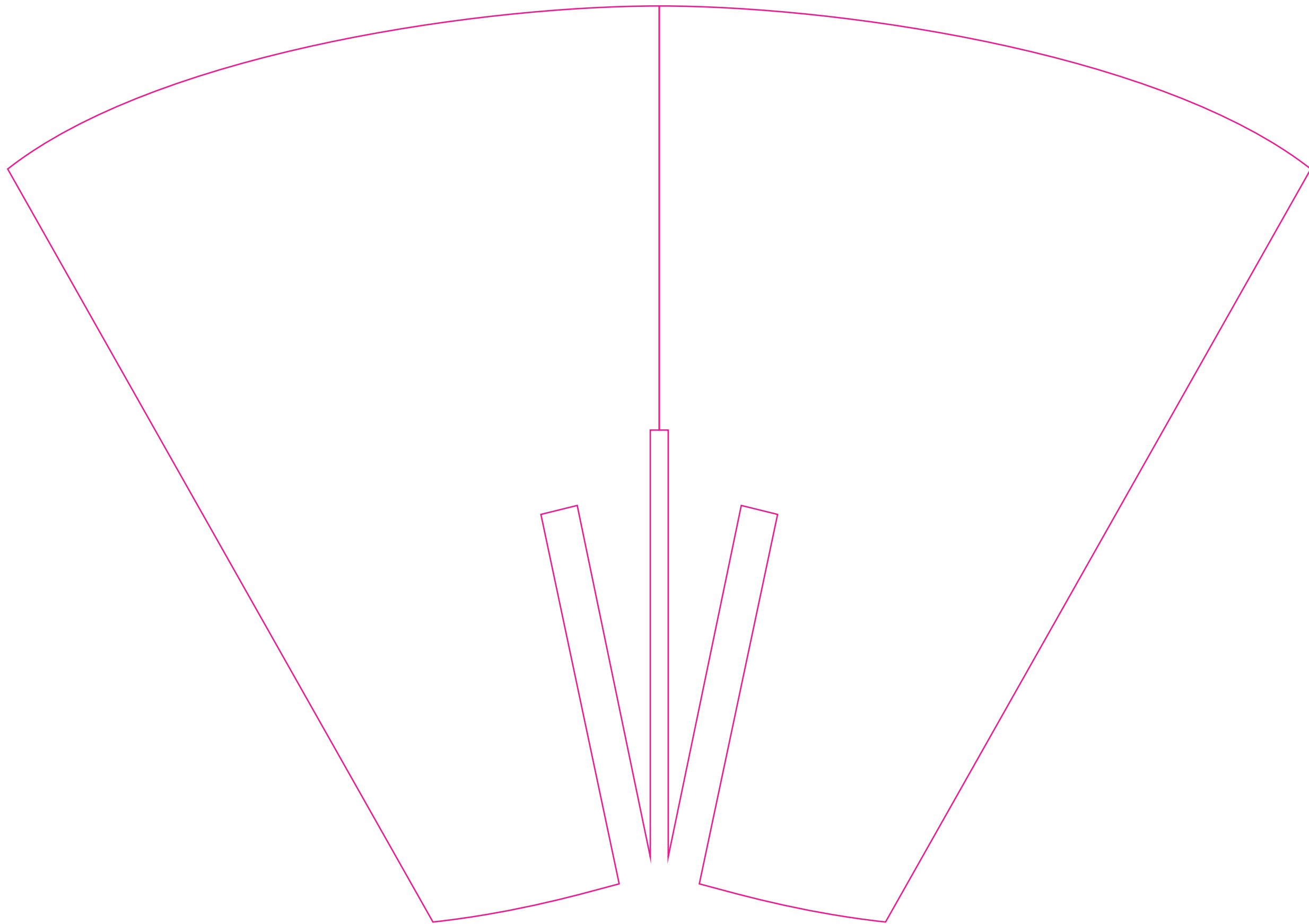

Canopy for Razorback version

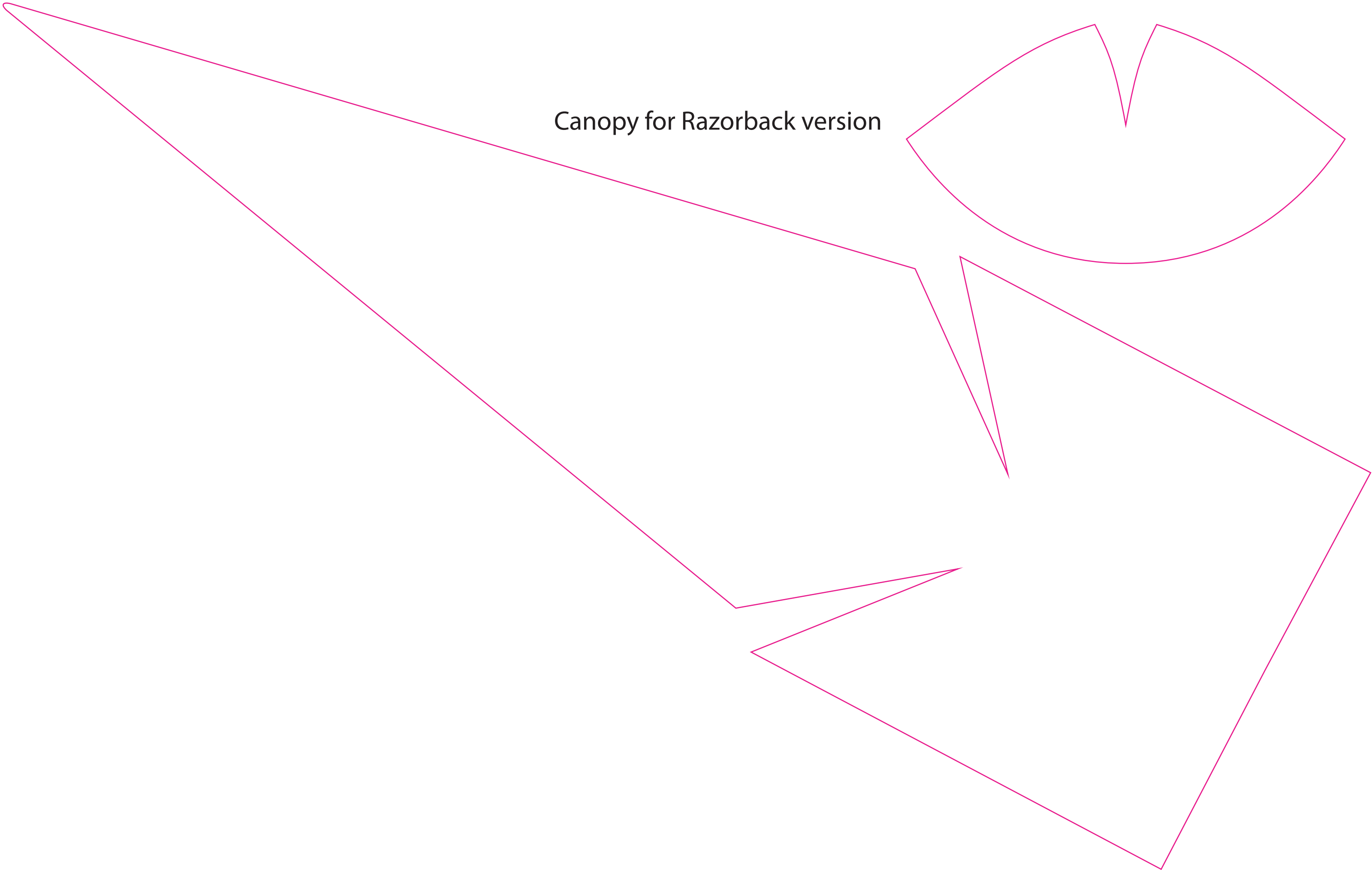

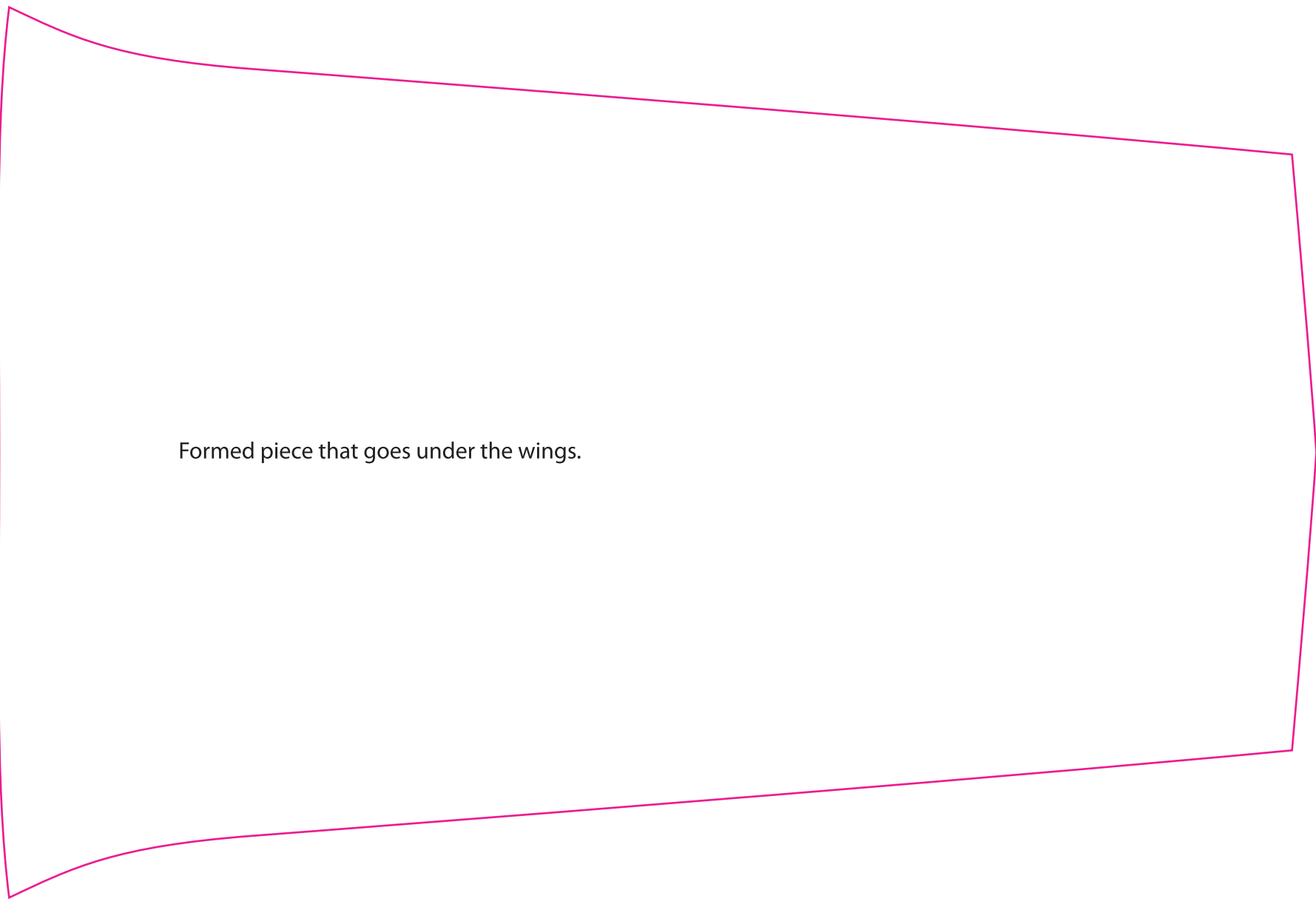

Formed piece that goes under the wings.

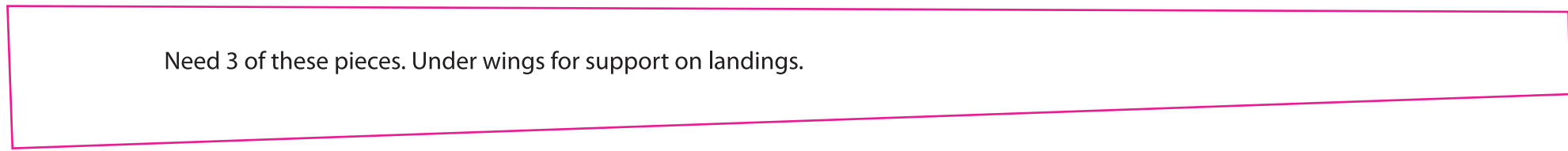

Need 3 of these pieces. Under wings for support on landings.

