

30"

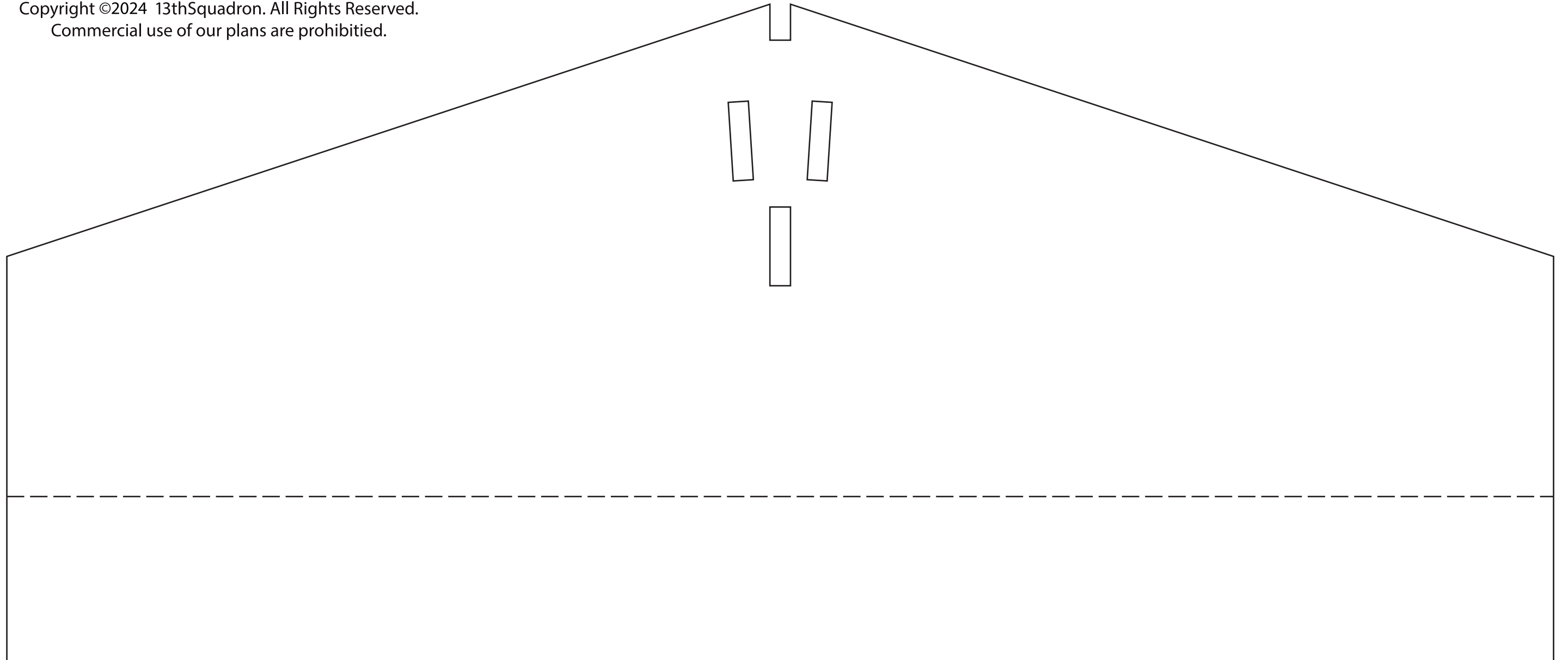

Copyright ©2024 13thSquadron. All Rights Reserved.
Commercial use of our plans are prohibited.

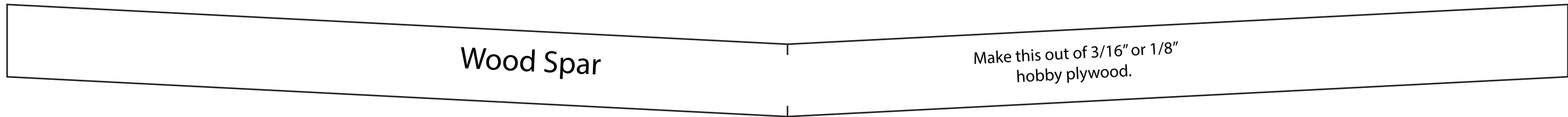



Copyright ©2024 13thSquadron. All Rights Reserved.
Commercial use of our plans are prohibited.

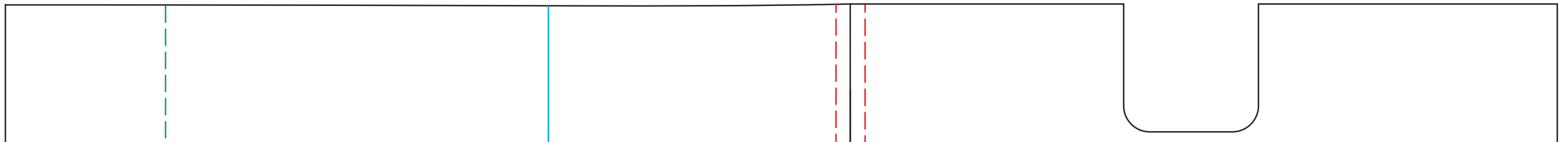
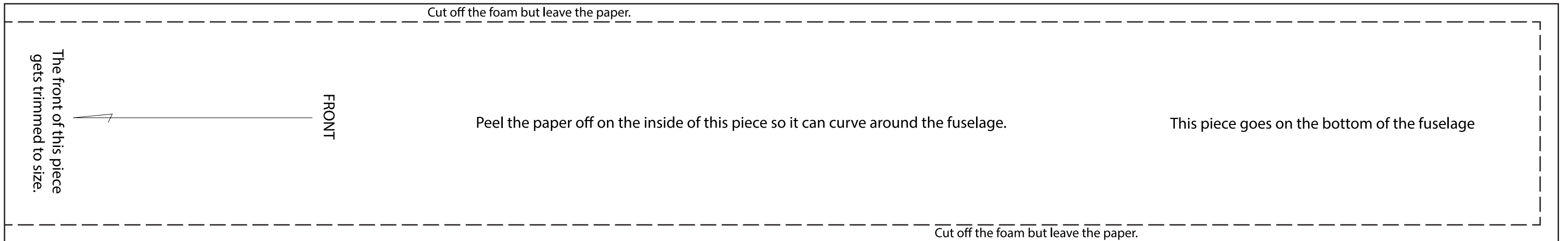

Copyright ©2024 13thSquadron. All Rights Reserved.
Commercial use of our plans are prohibited.

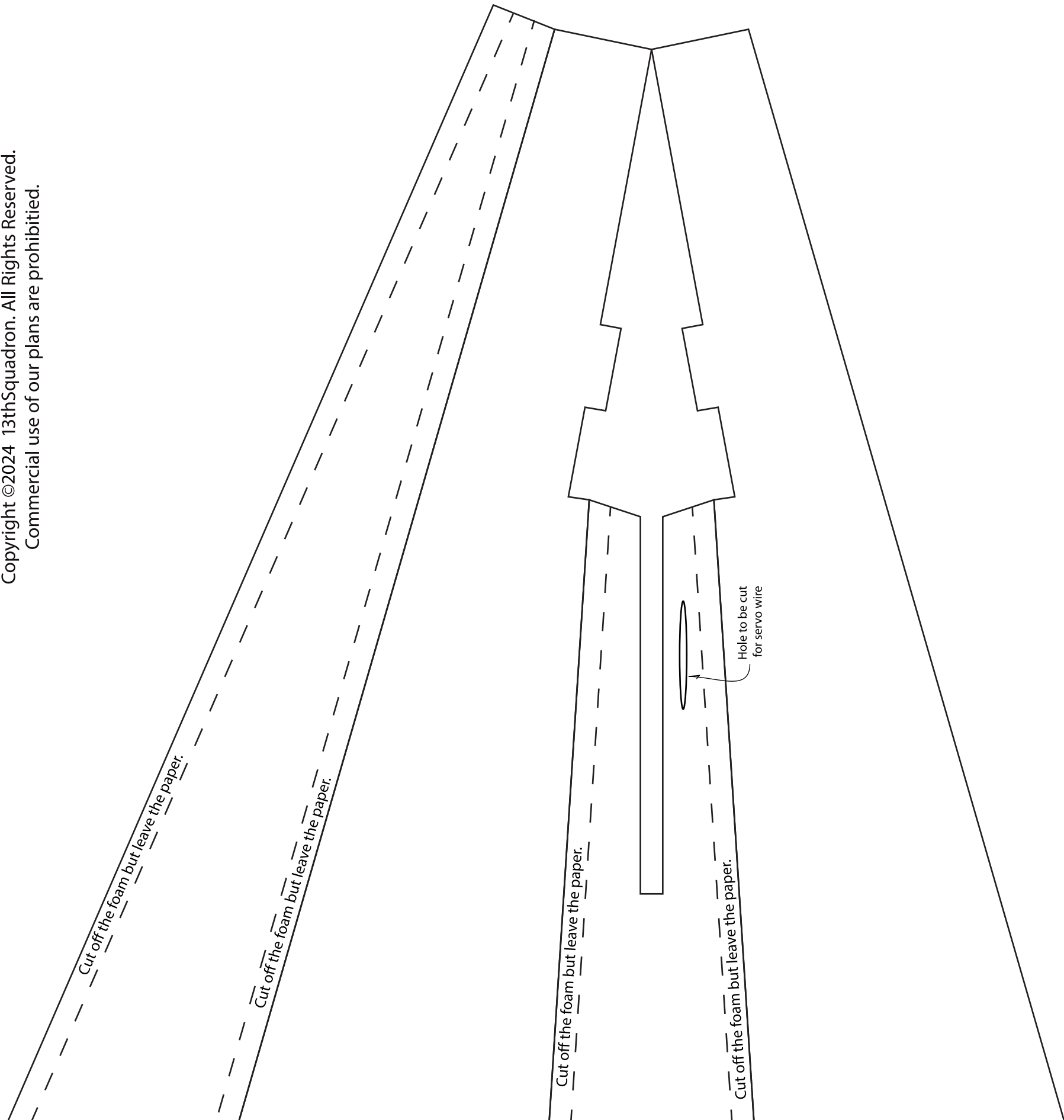

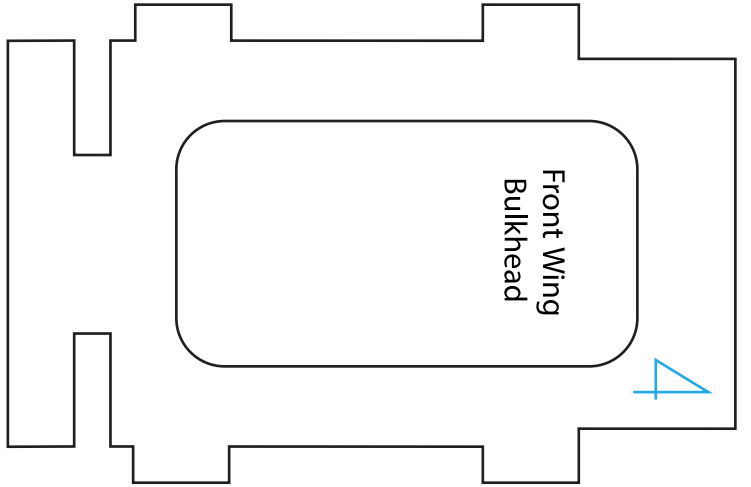
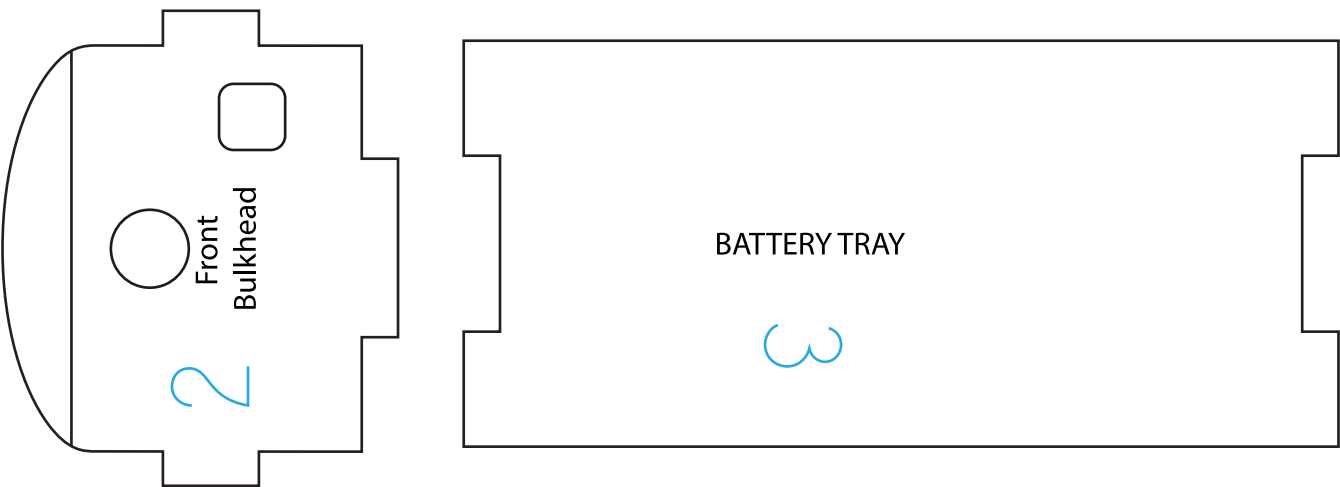
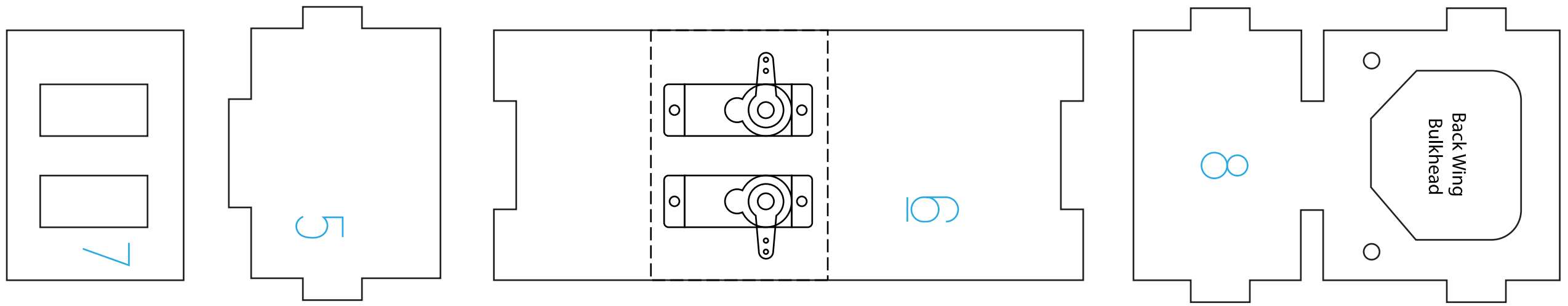

Copyright ©2024 13thSquadron. All Rights Reserved.
Commercial use of our plans are prohibited.

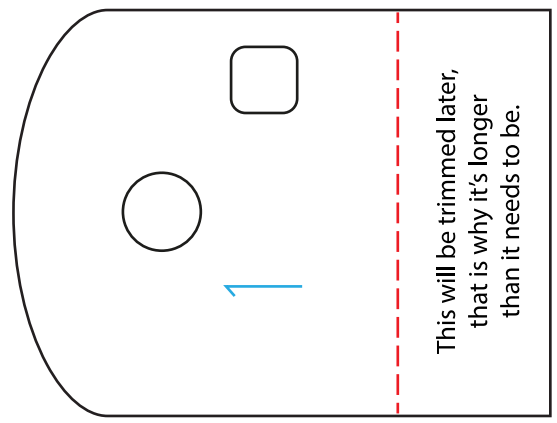

This will be trimmed later,
that is why it's longer
than it needs to be.

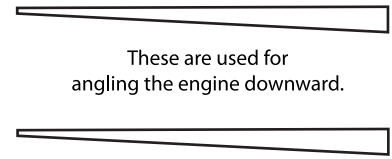
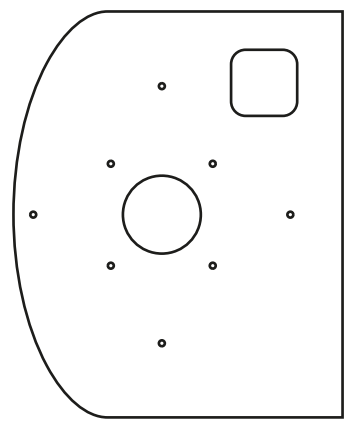
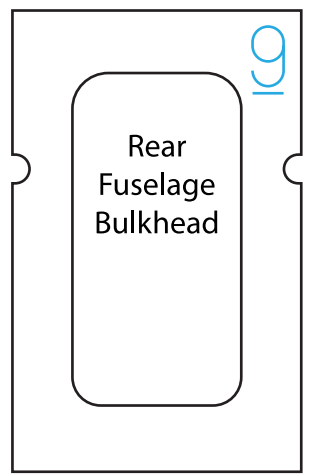

These are used for
angling the engine downward.

Make this out of 3/16" or 1/8"
hobby plywood.



Keep the paper on in this area.

18"

Peel off paper on this side of the wing.

Cut a 45° Degree Bevel between the top wing and the lower wing before glueing.

Keep the paper on in this side of the wing.

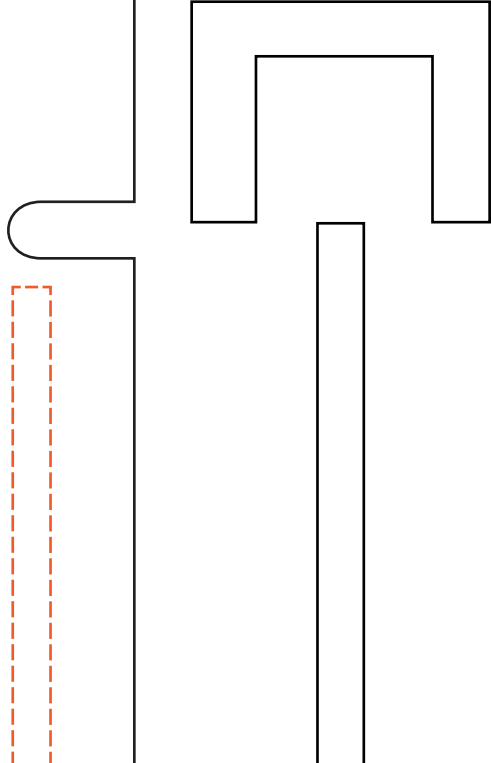
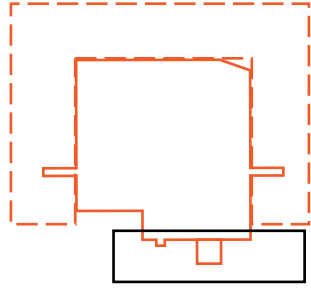

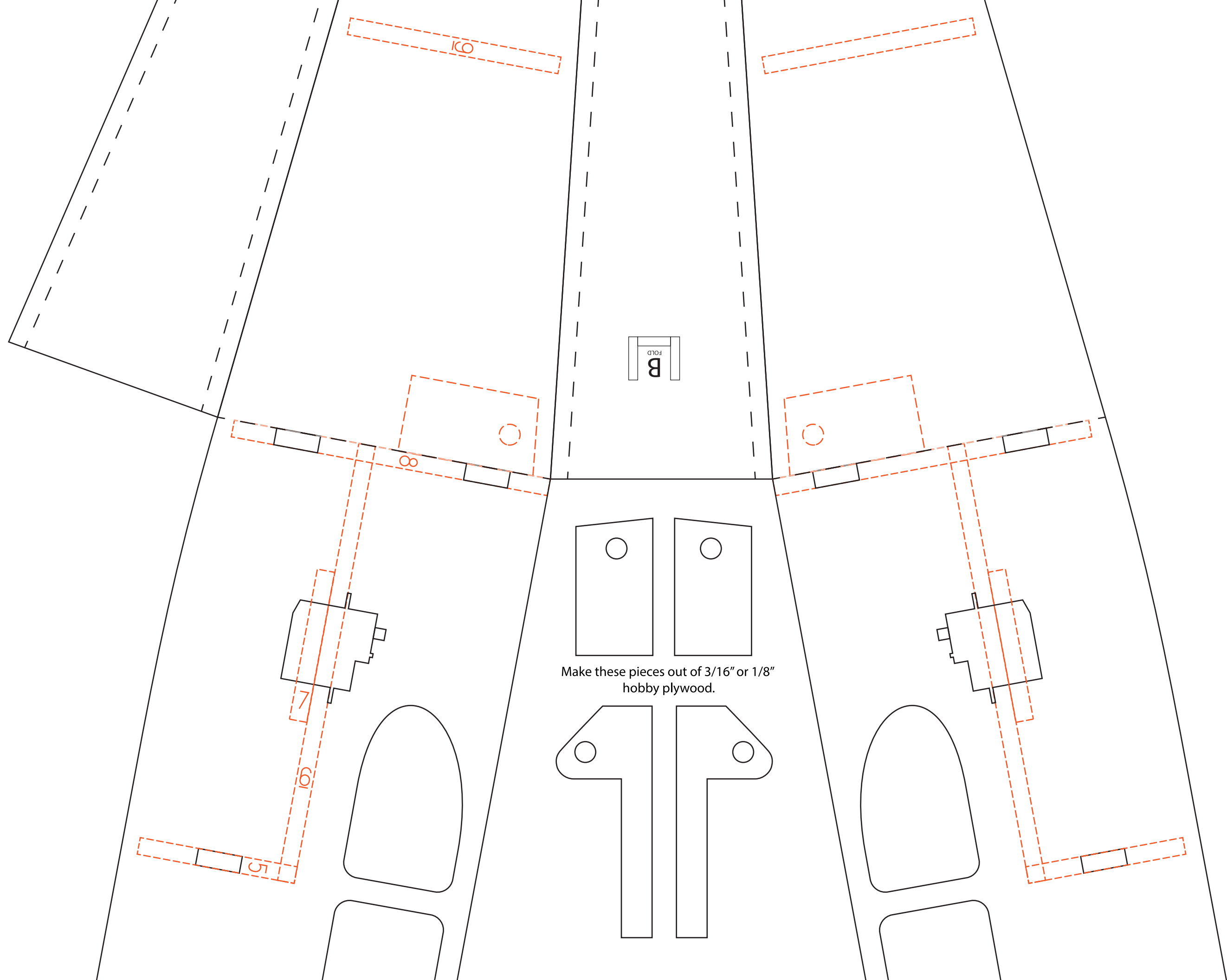

100

100

B
fold

8

8

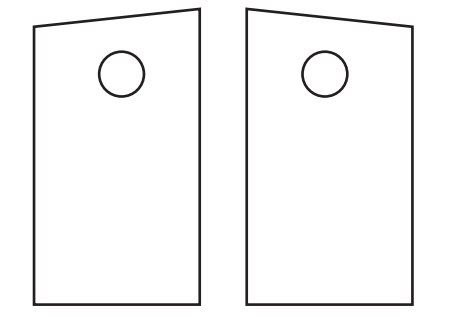

Make these pieces out of 3/16" or 1/8" hobby plywood.

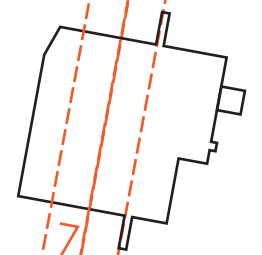
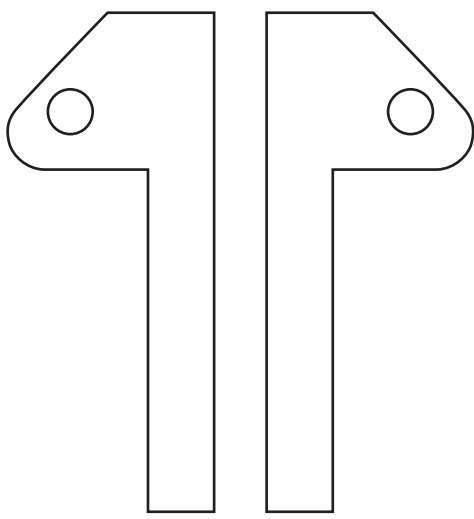

7

6

5

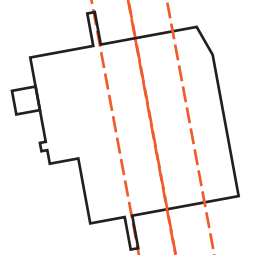

5

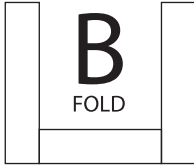
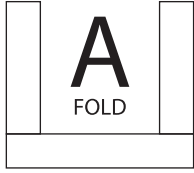

Keep paper on both sides of the ailerons.

22 1/4"

Flip this wing over to make the pattern for the other wing.

Cut a bevel here to fold the wingtip up.

Peel off the paper on the wingtip.

Cut this piece and glue here to strengthen the wing.

You cut this wingtip longer because you will be trimming it later.

18"

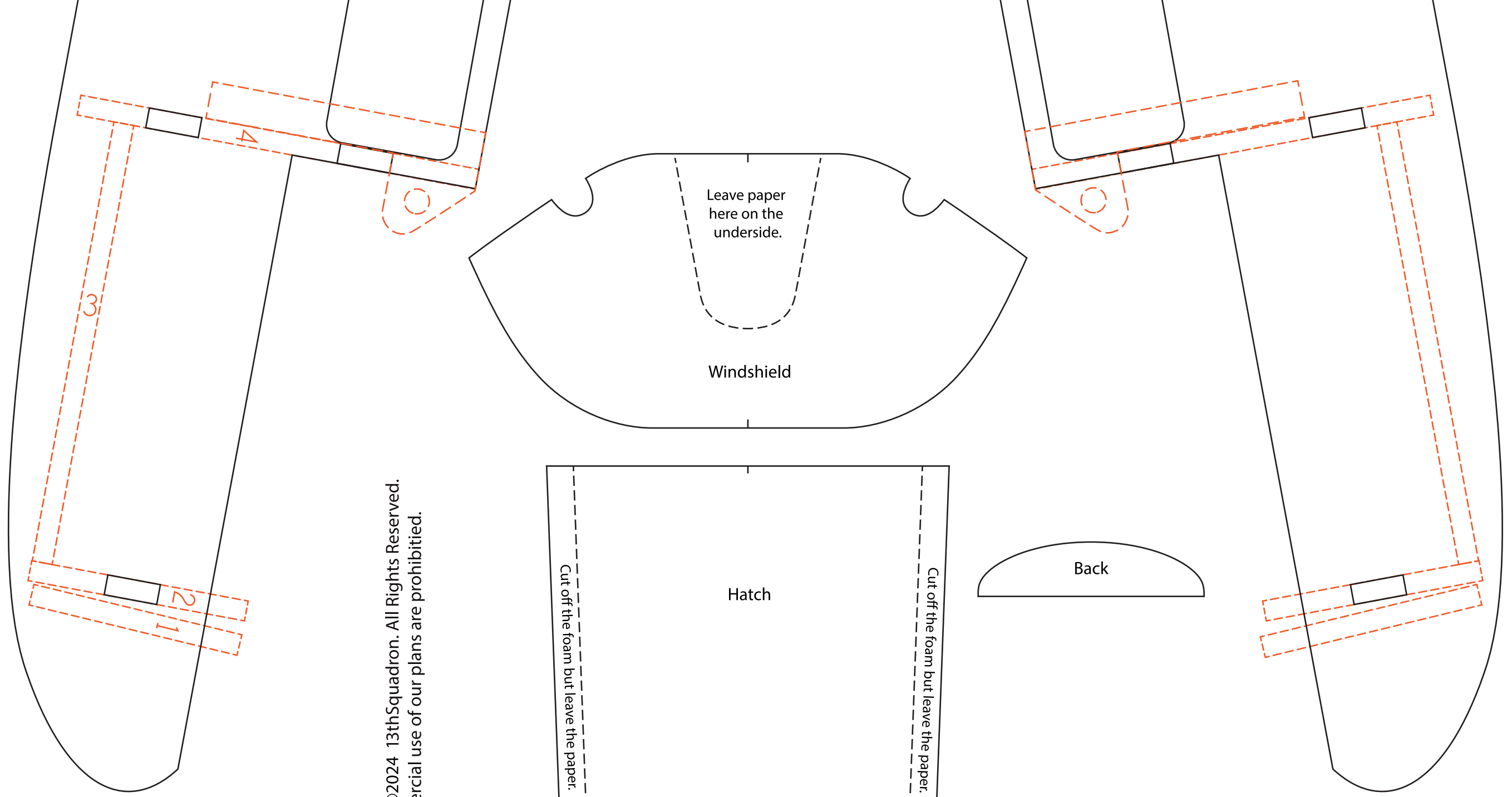

18"

Copyright ©2024 13thSquadron. All Rights Reserved.
 Commercial use of our plans are prohibited.

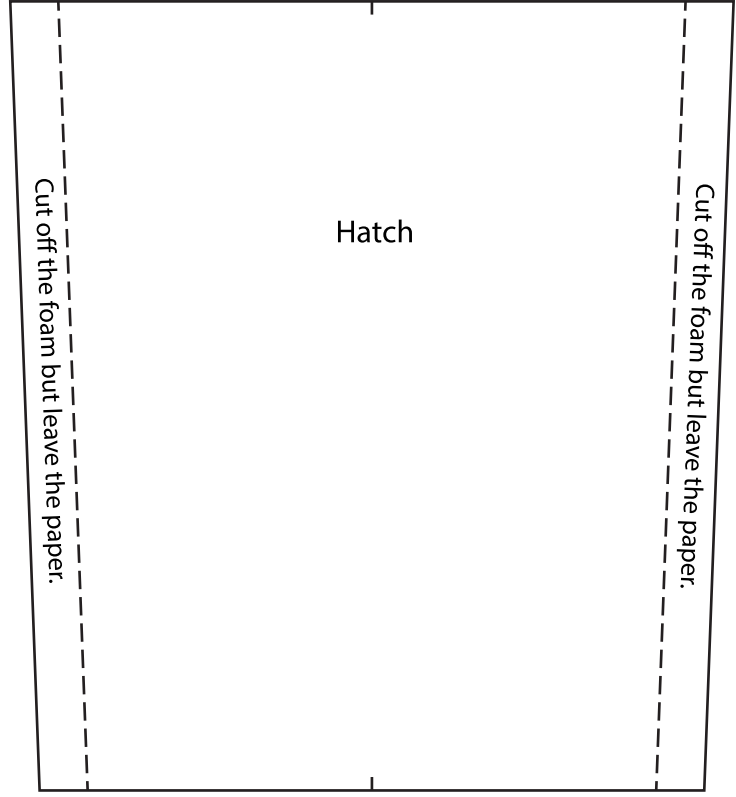
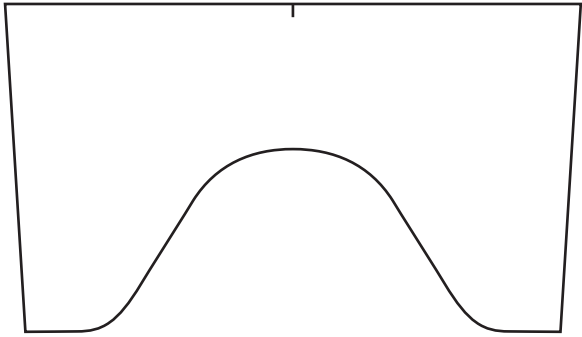

Front

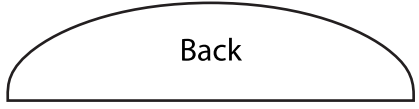

Back

Hatch

Windshield

Leave paper here on the underside.

3

2

1

4