

Trim off excess foam after glueing in these curved areas

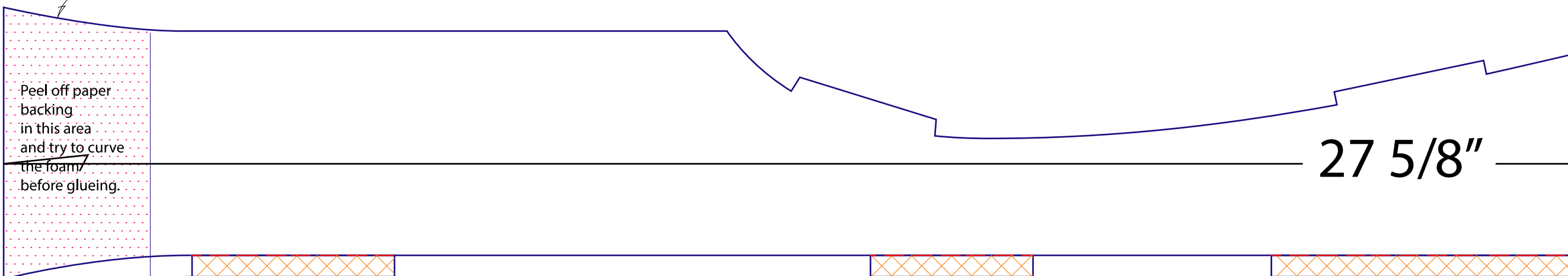

Peel off paper backing in this area and try to curve the foam before glueing.

27 5/8"

Engine Mount Line

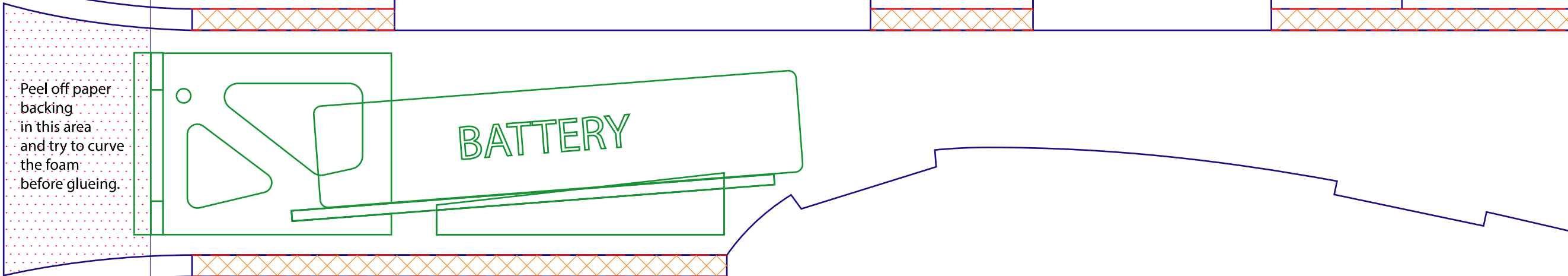

Peel off paper backing in this area and try to curve the foam before glueing.

BATTERY

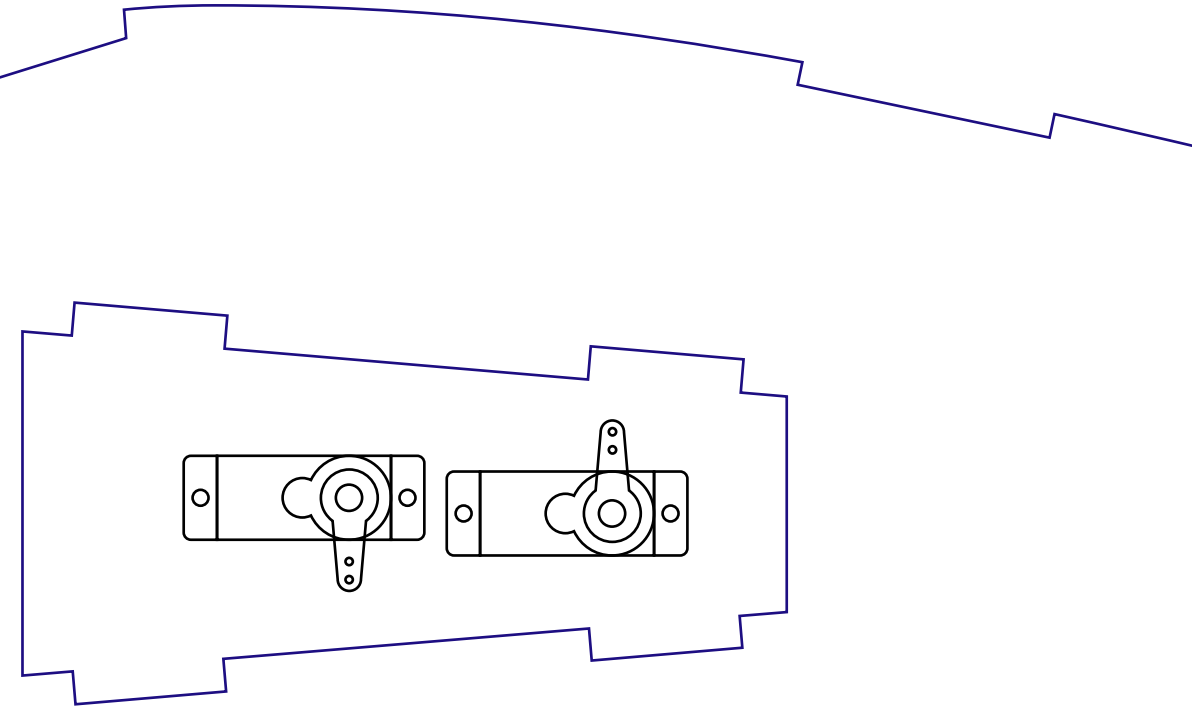
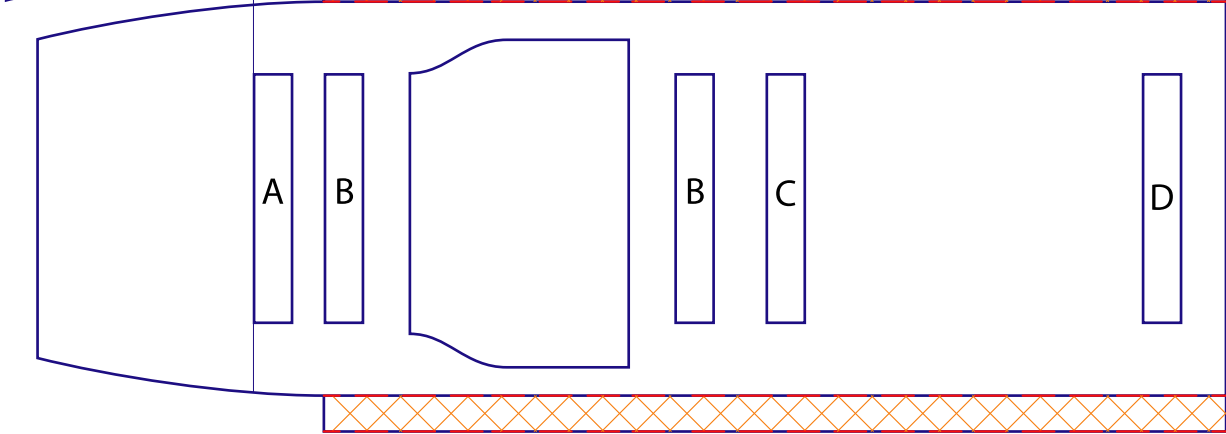

We don't have any templates for below the nose, we kind of just geussed on those as well. There is the one piece for covering up the "radiator" but the length of that needs adjusted also.

Copyright ©2020 13thSquadron. All Rights Reserved.
Commercial use of our plans are prohibited.

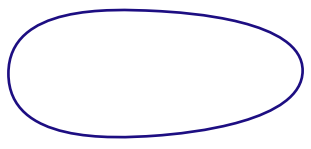
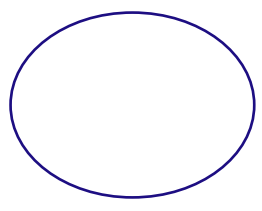
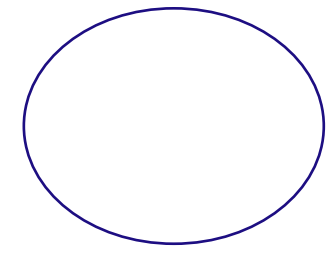
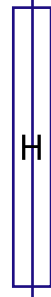
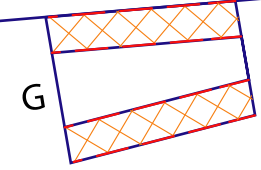
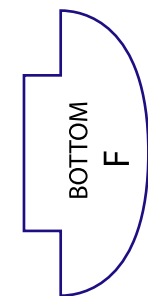
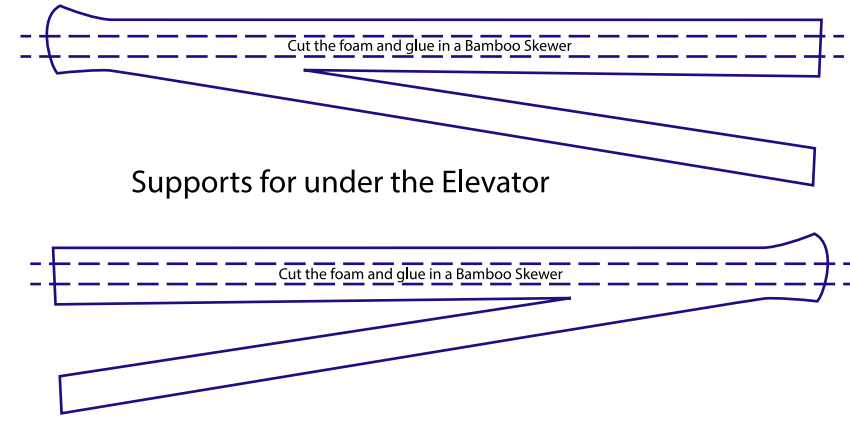
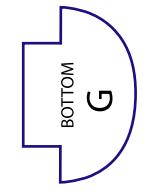
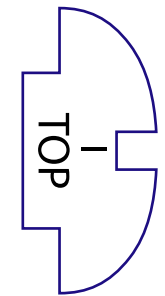
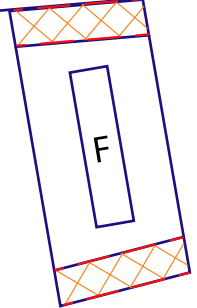
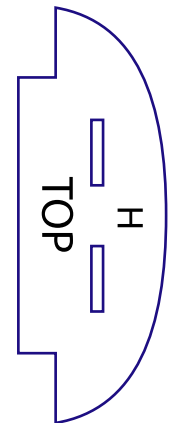
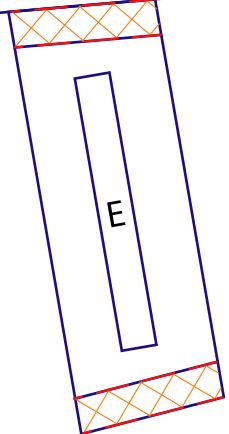
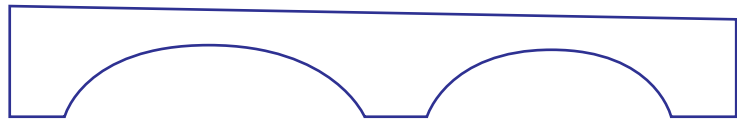
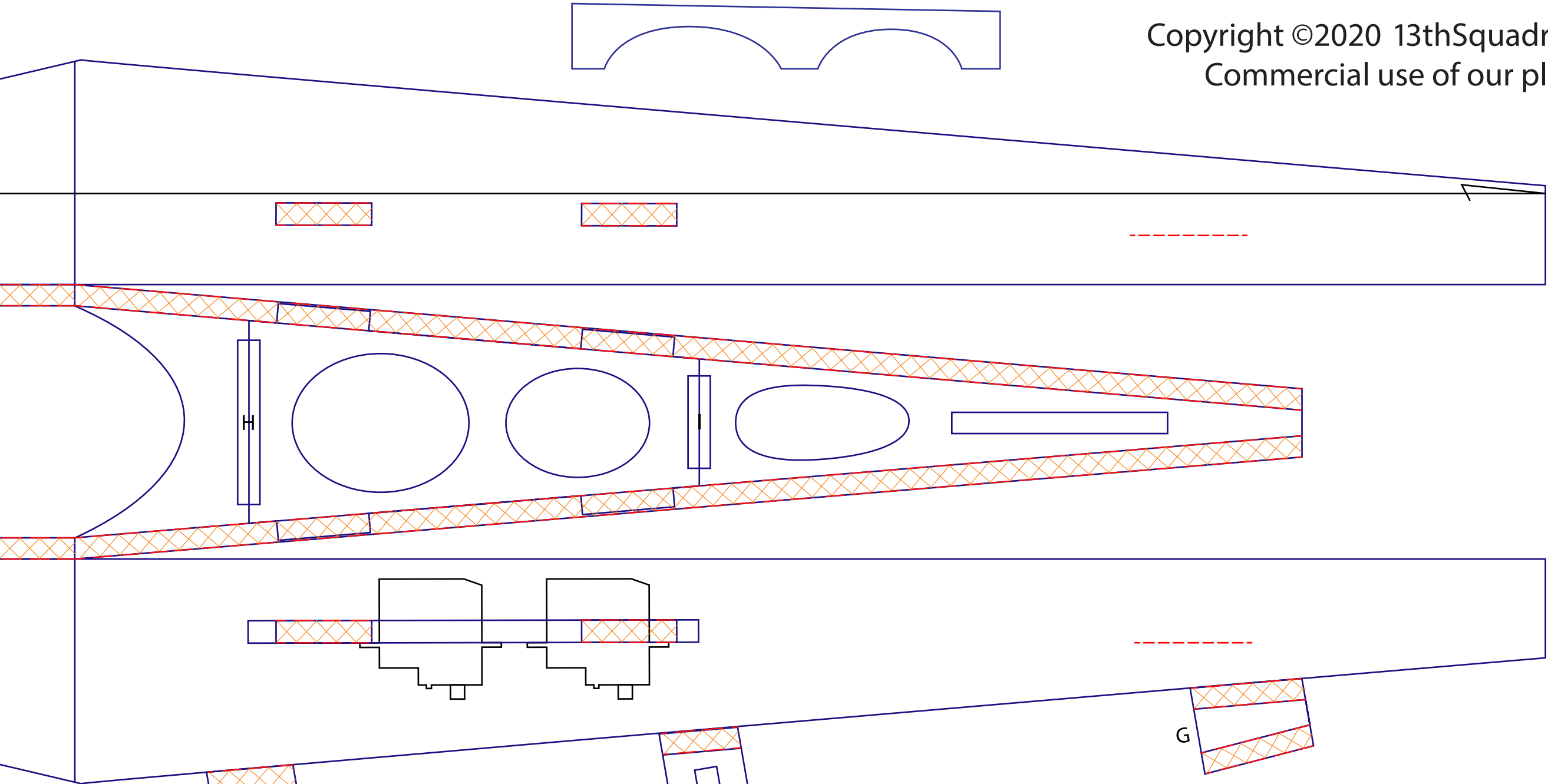

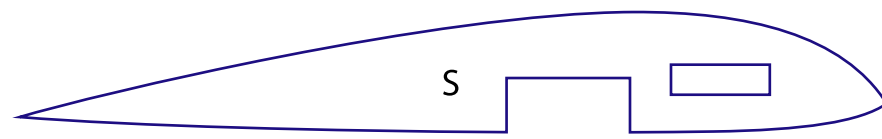
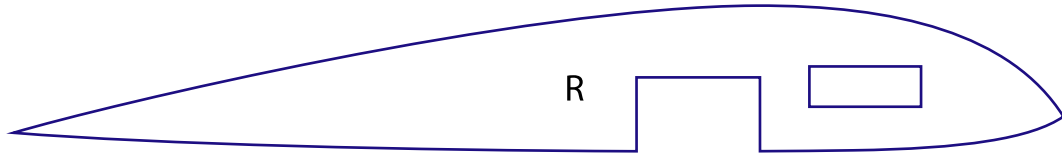
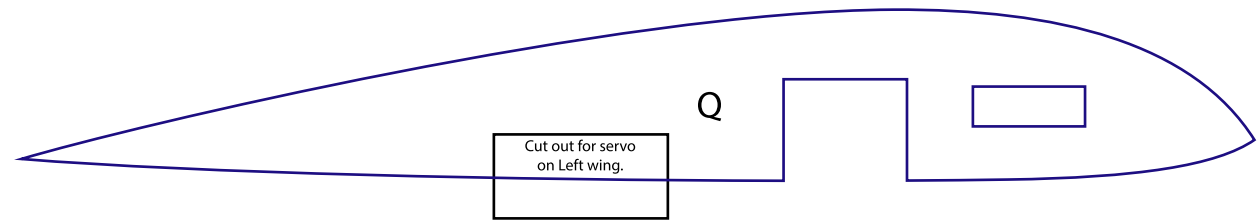
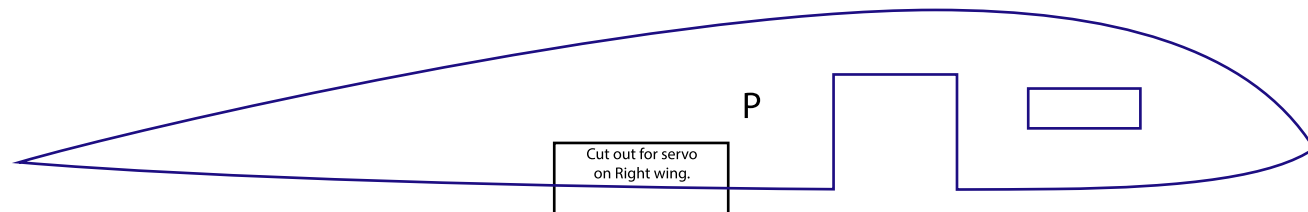
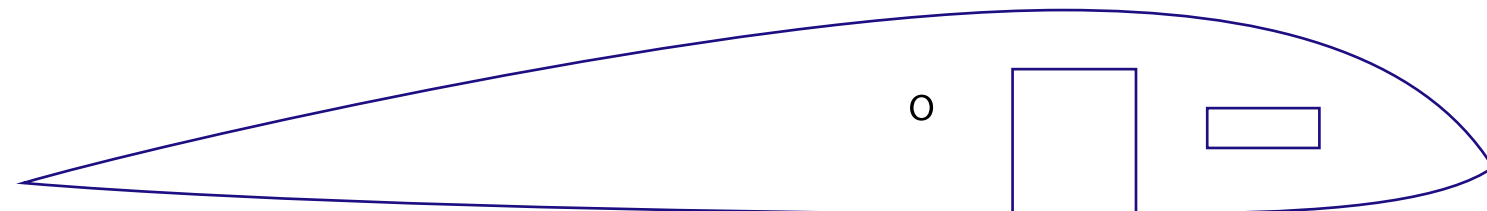
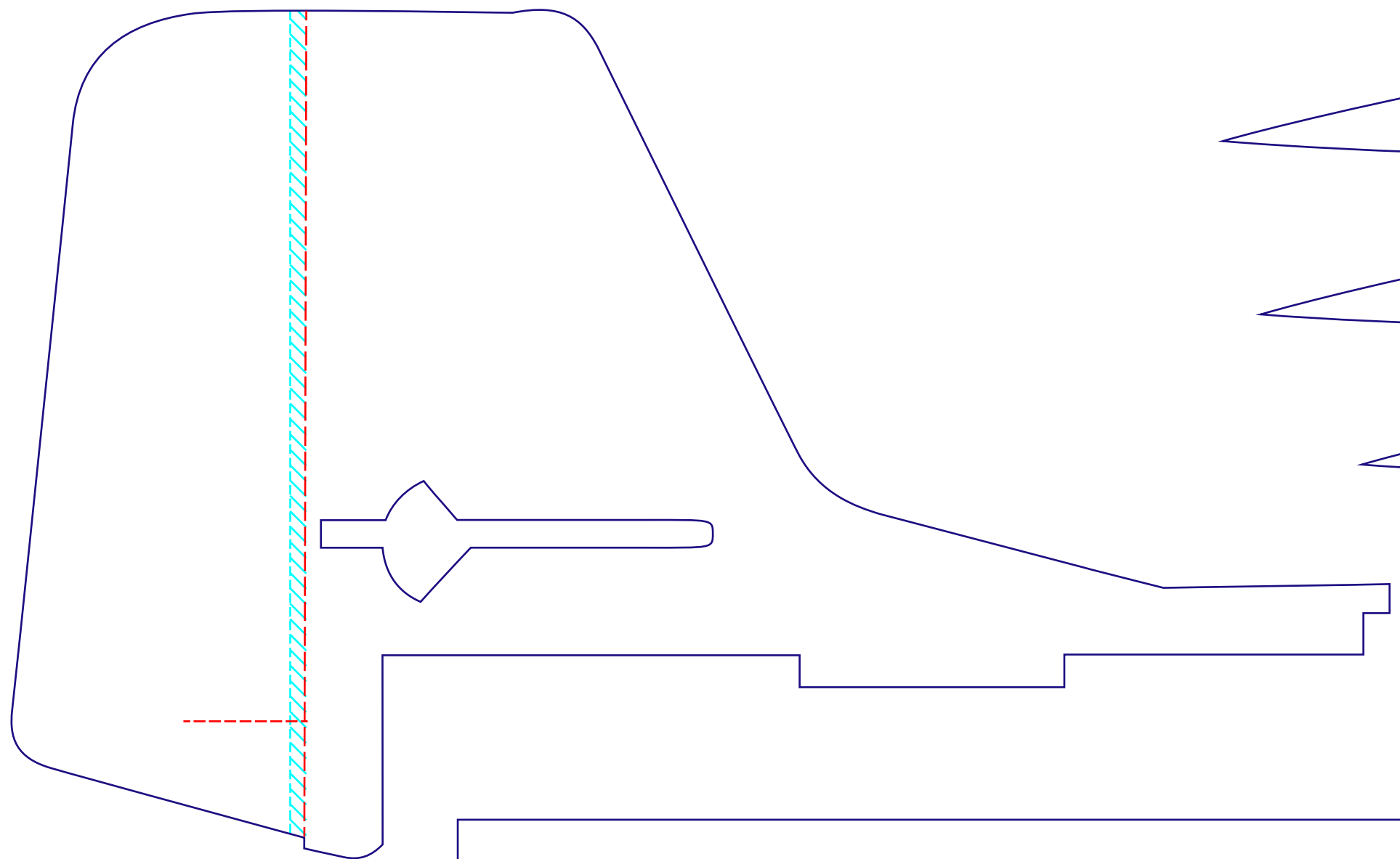

Cowling in the Front (Radiator)

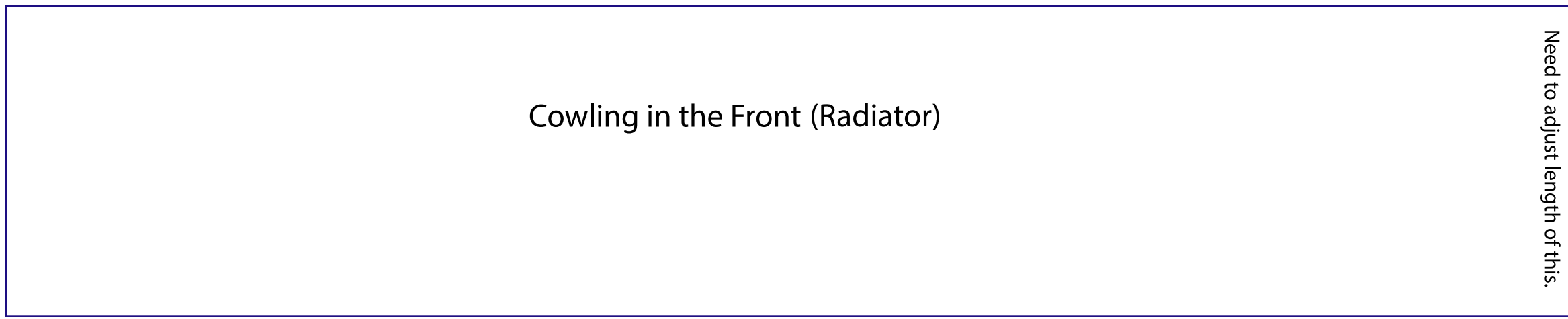

Need to adjust length of this.

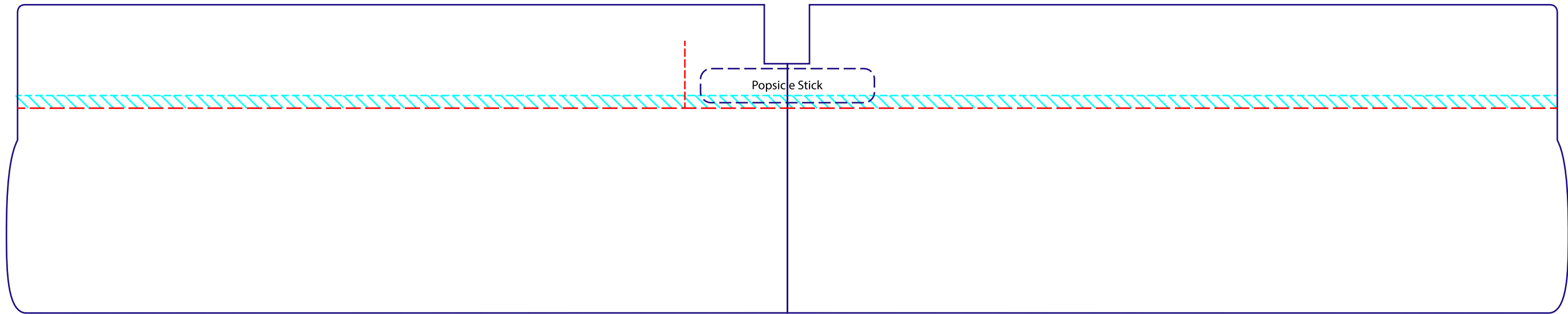
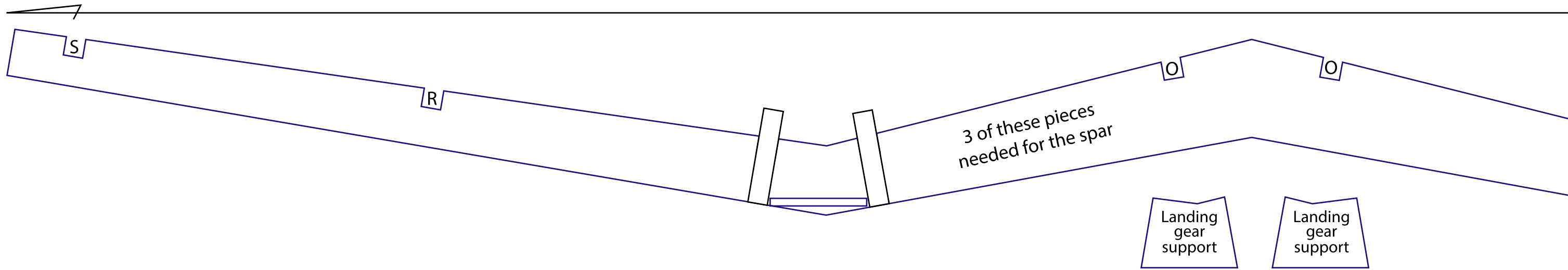

We thought about making these a little bit wider.

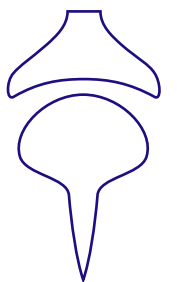
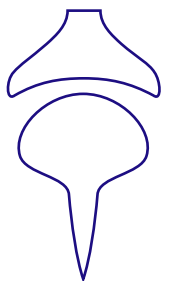
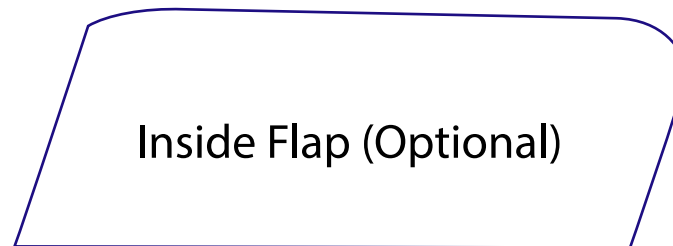
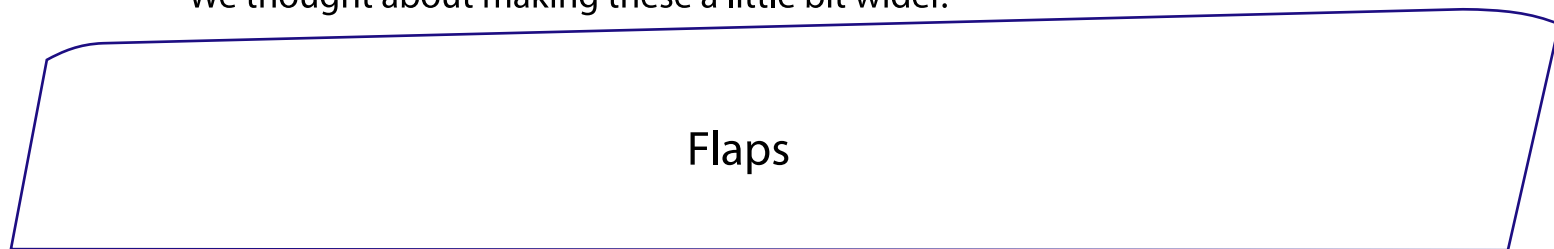

24 15/16" shy

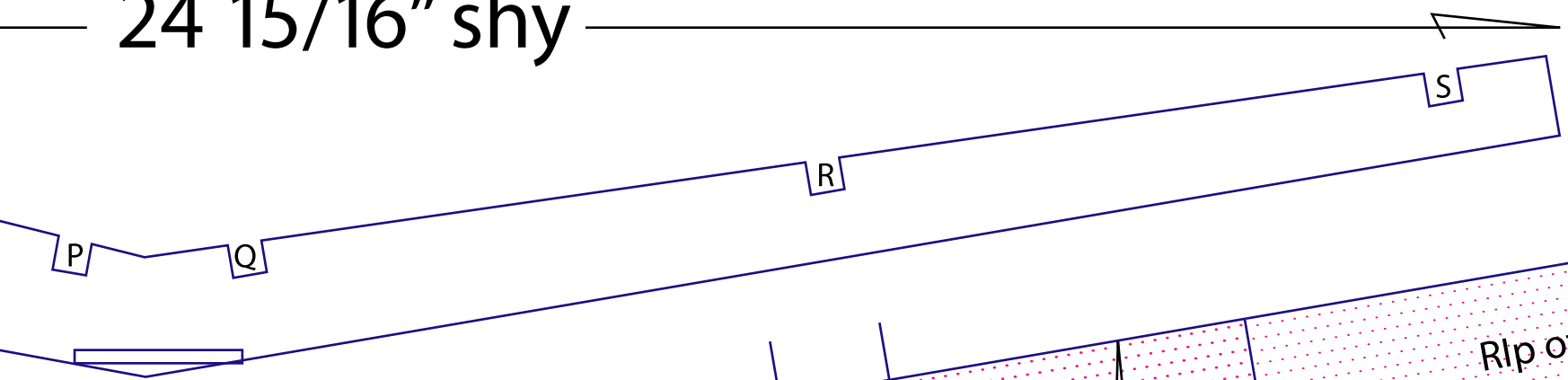

Rip off the paper on the inside of the wing so you get a better curve

RIGHT WING

Place wing rib here

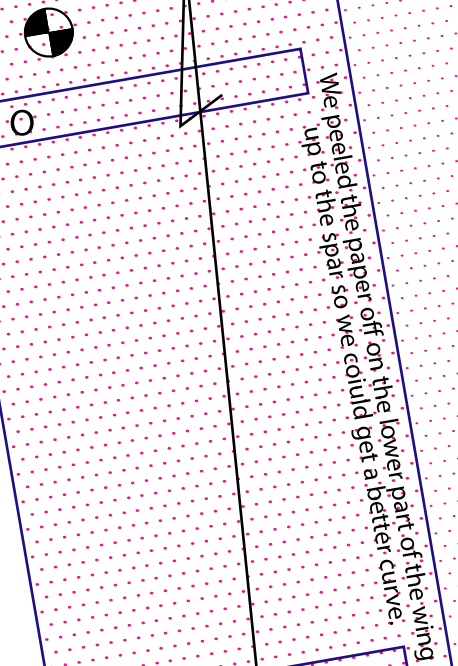

You might need to adjust the curves of these lines to make it fit better when you fold the wing.

Place wing rib here

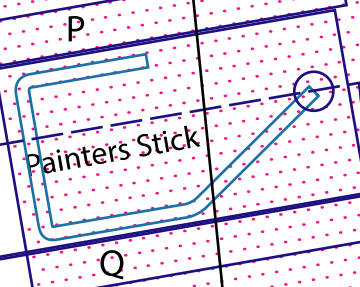
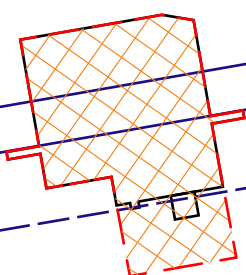

Place wing rib here

19 7/8"

Cut the paper at this line and

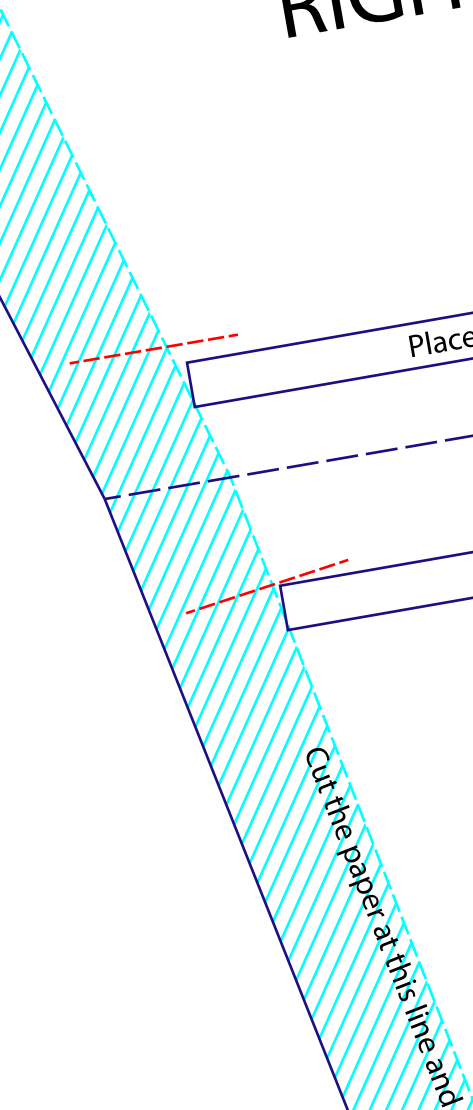

R

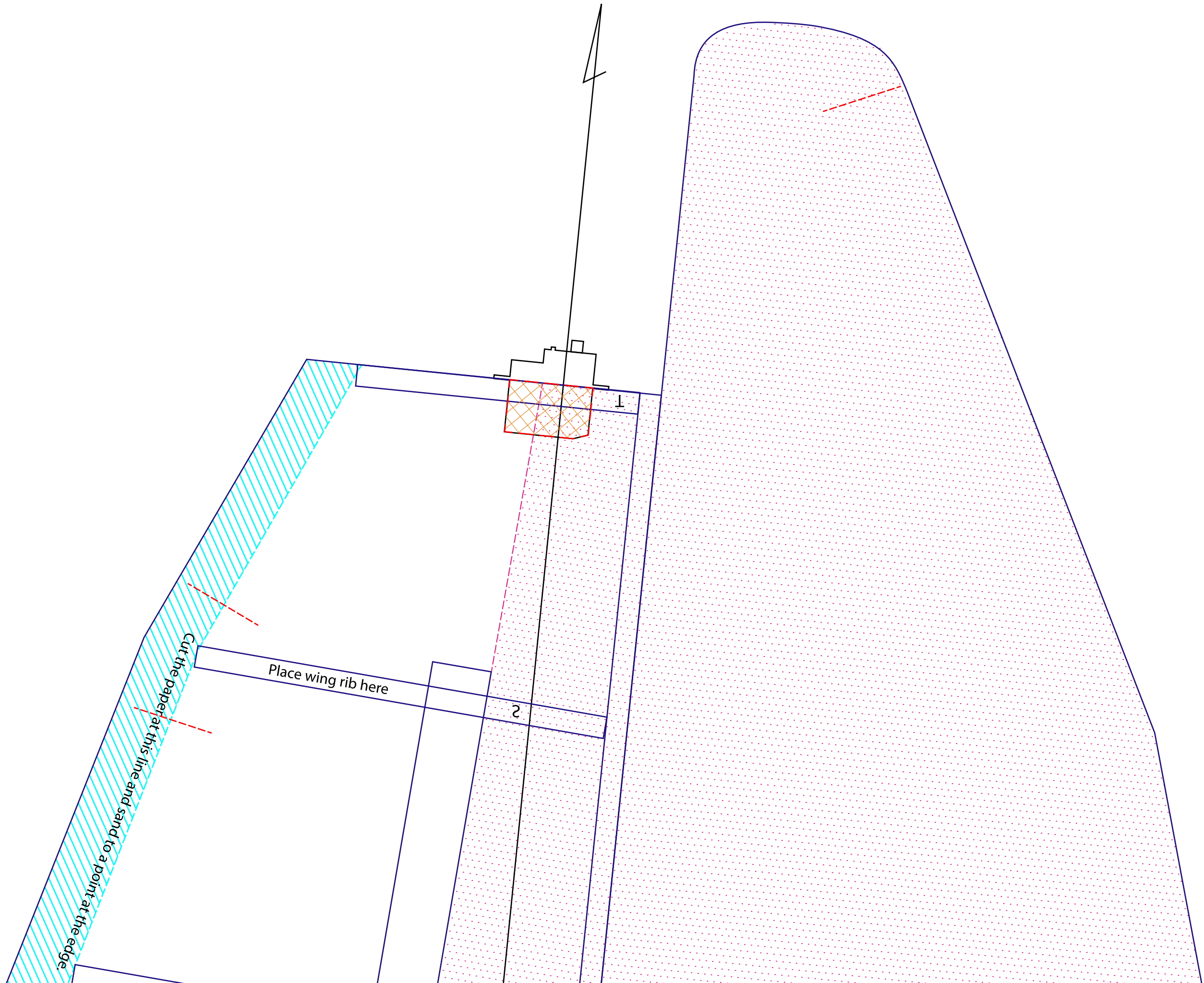

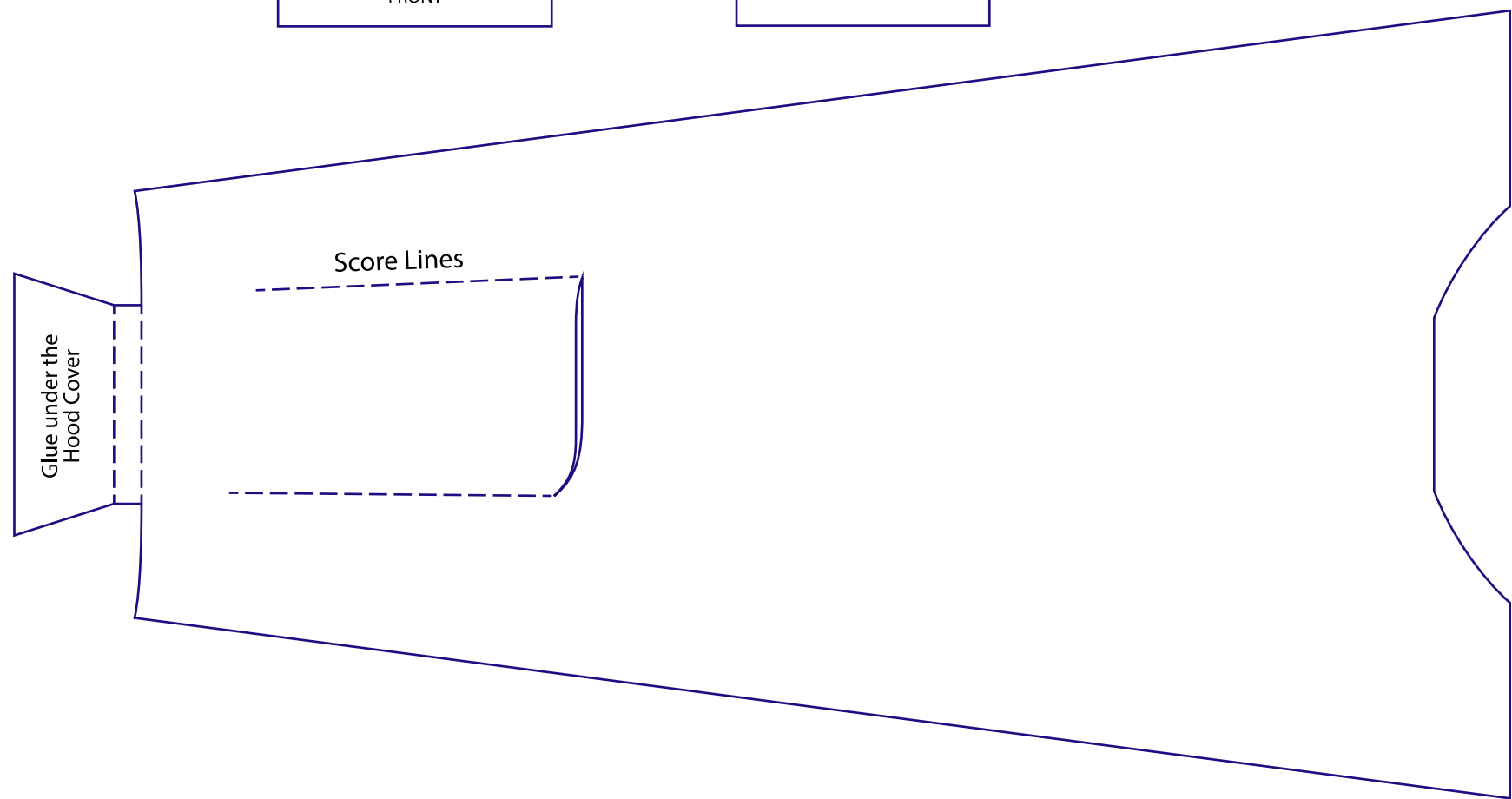
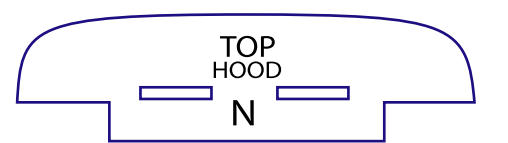
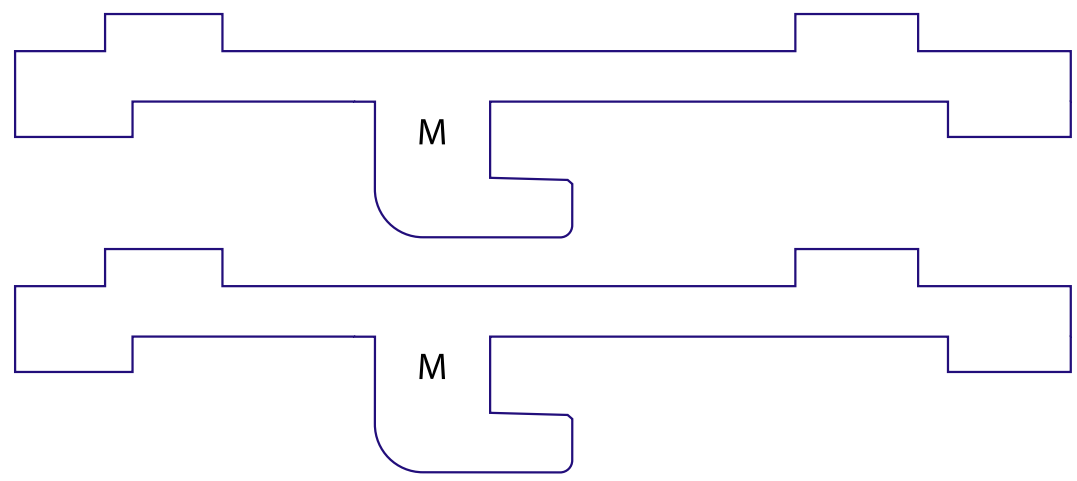
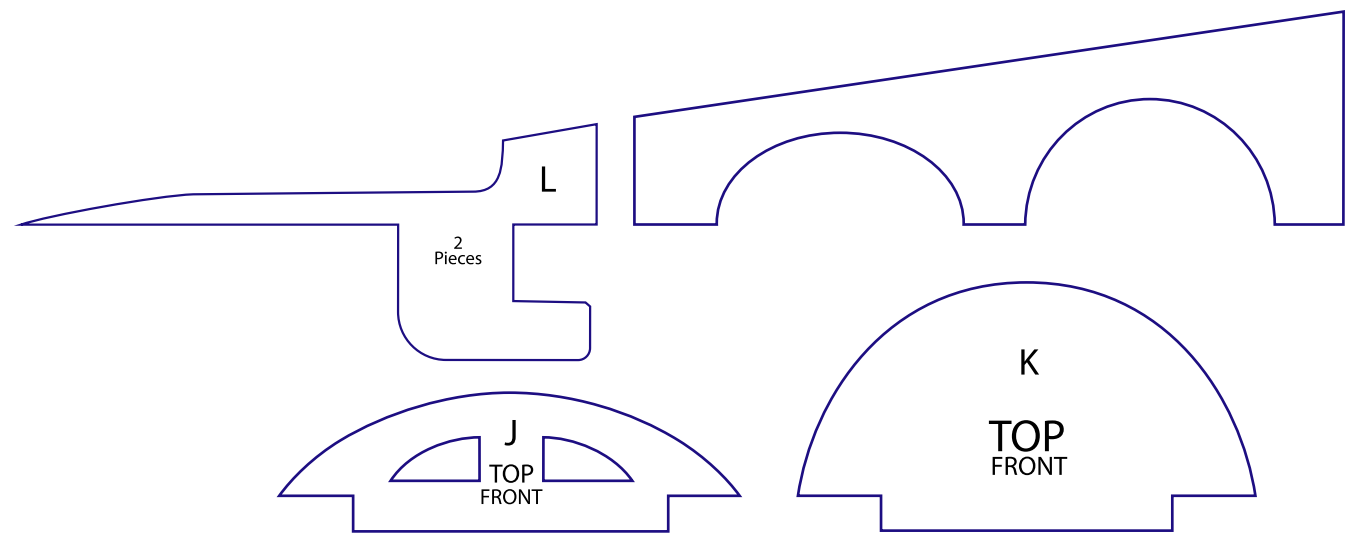
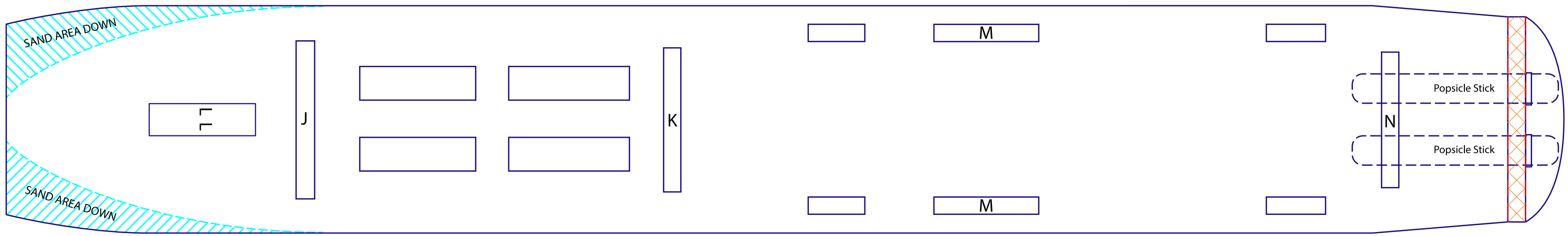

We don't have any real plan or guide for the posterboard behind the cockpit. We kind of just made it work.

We also don't have any real plan for underneath the cockpit. We just placed some foamboard underneath the cockpit to raise it up so it was level with the front and glued it in.

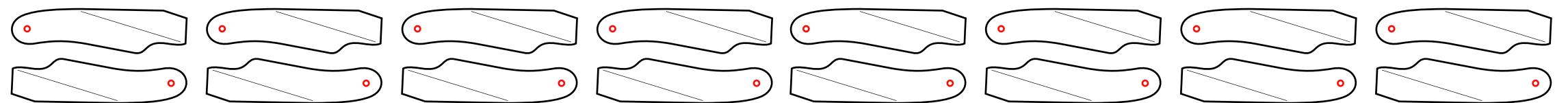
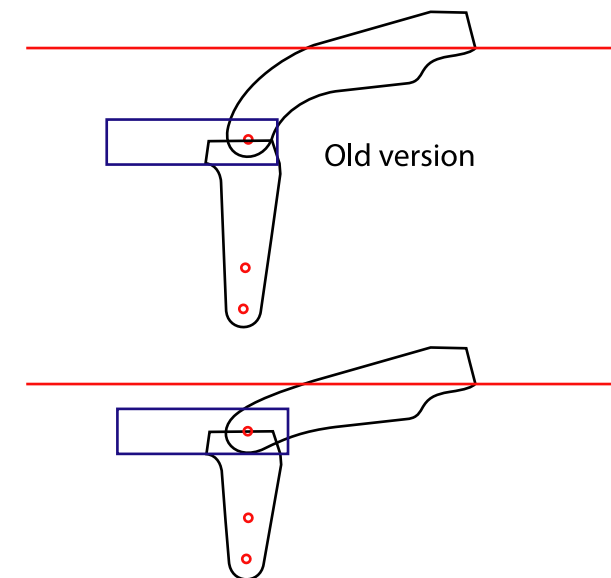
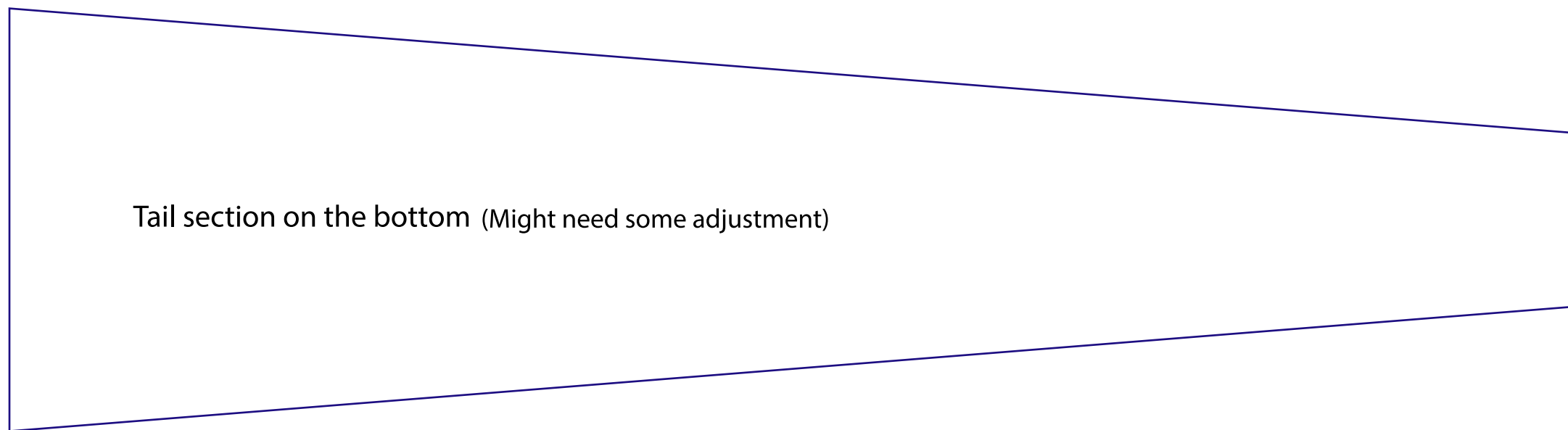
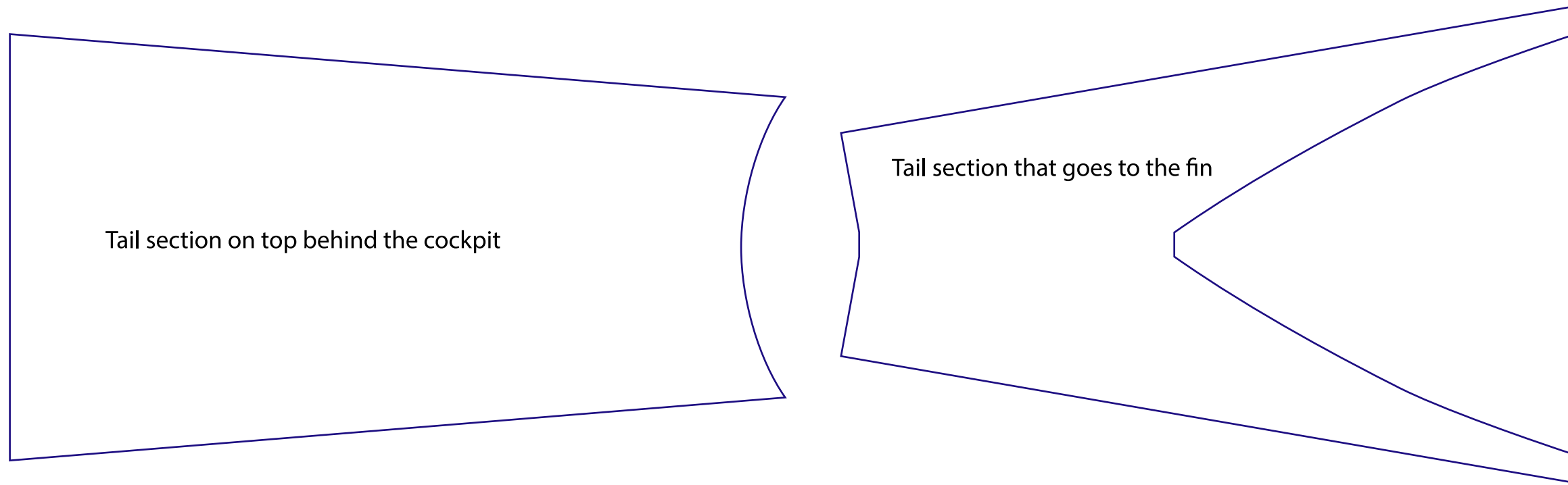

I had a friend of mine cut these on his laser cutter, otherwise I would have had to cut them out with my scroll saw.

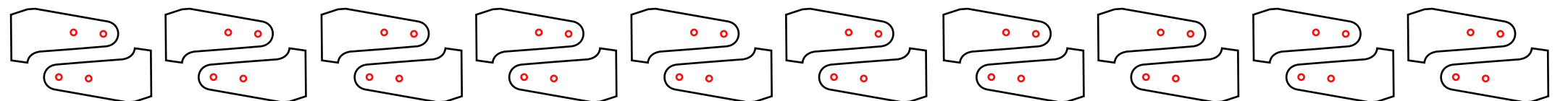

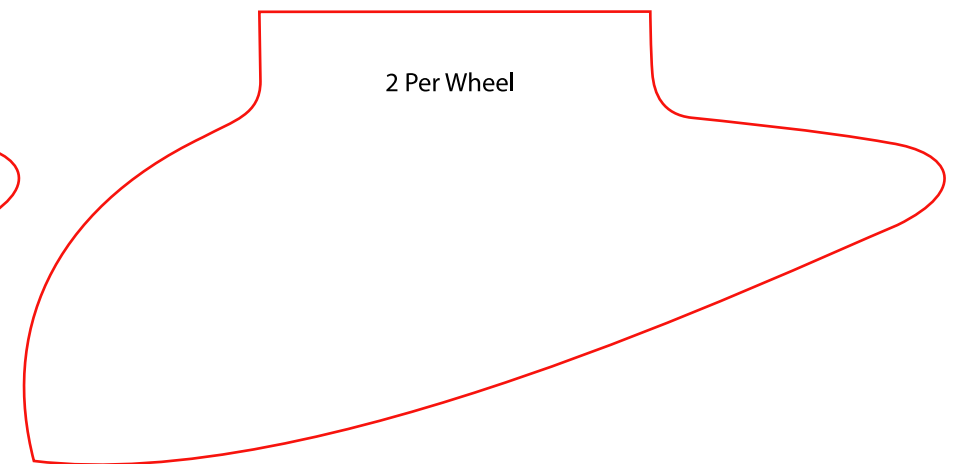
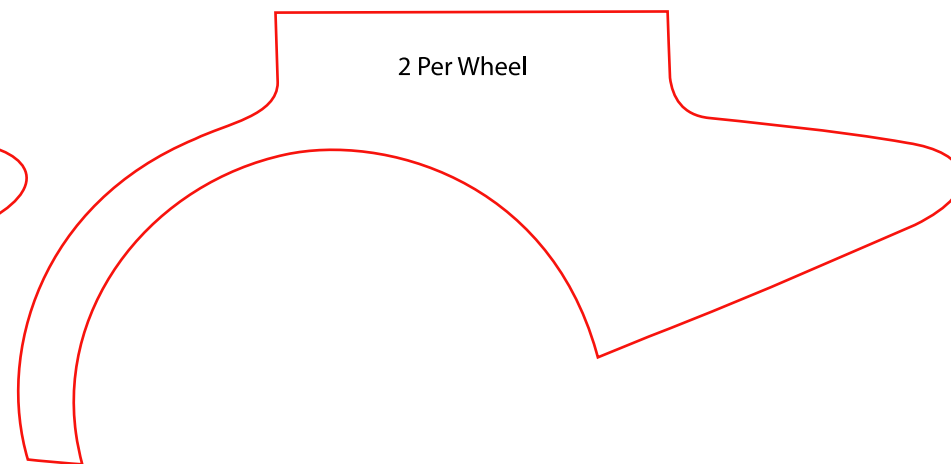
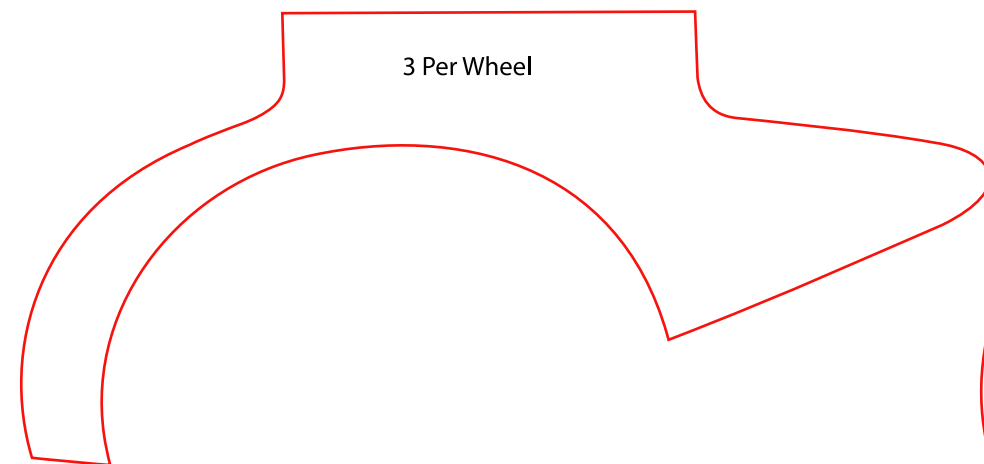
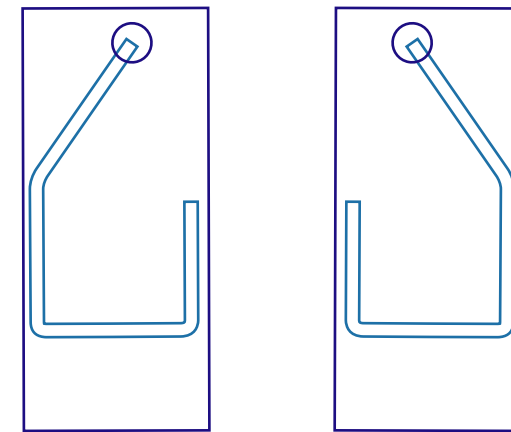
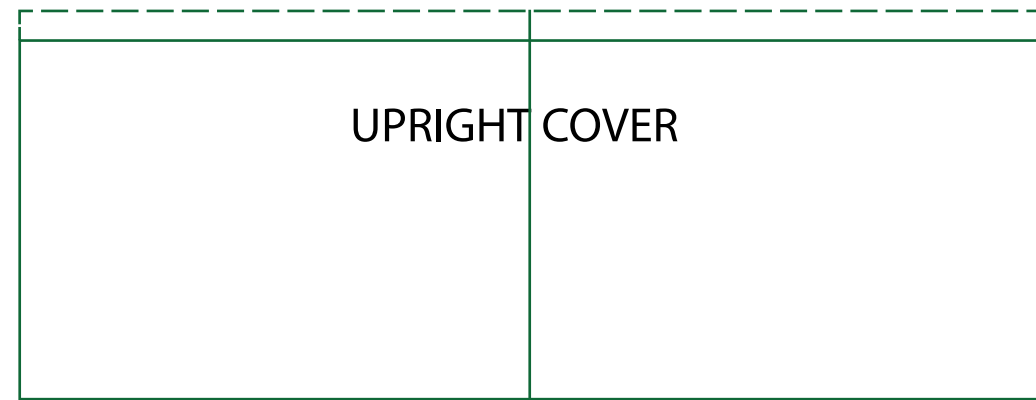
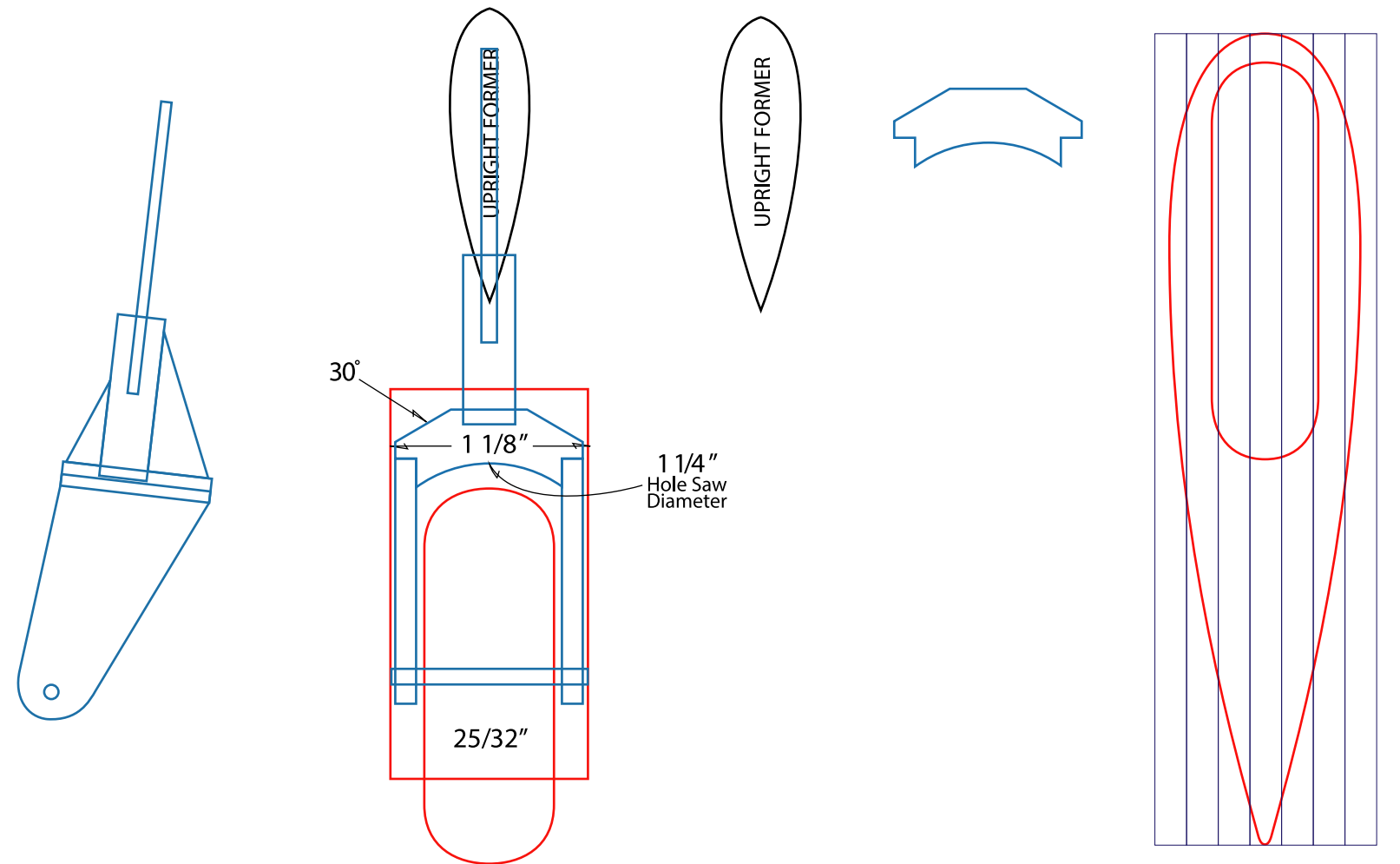
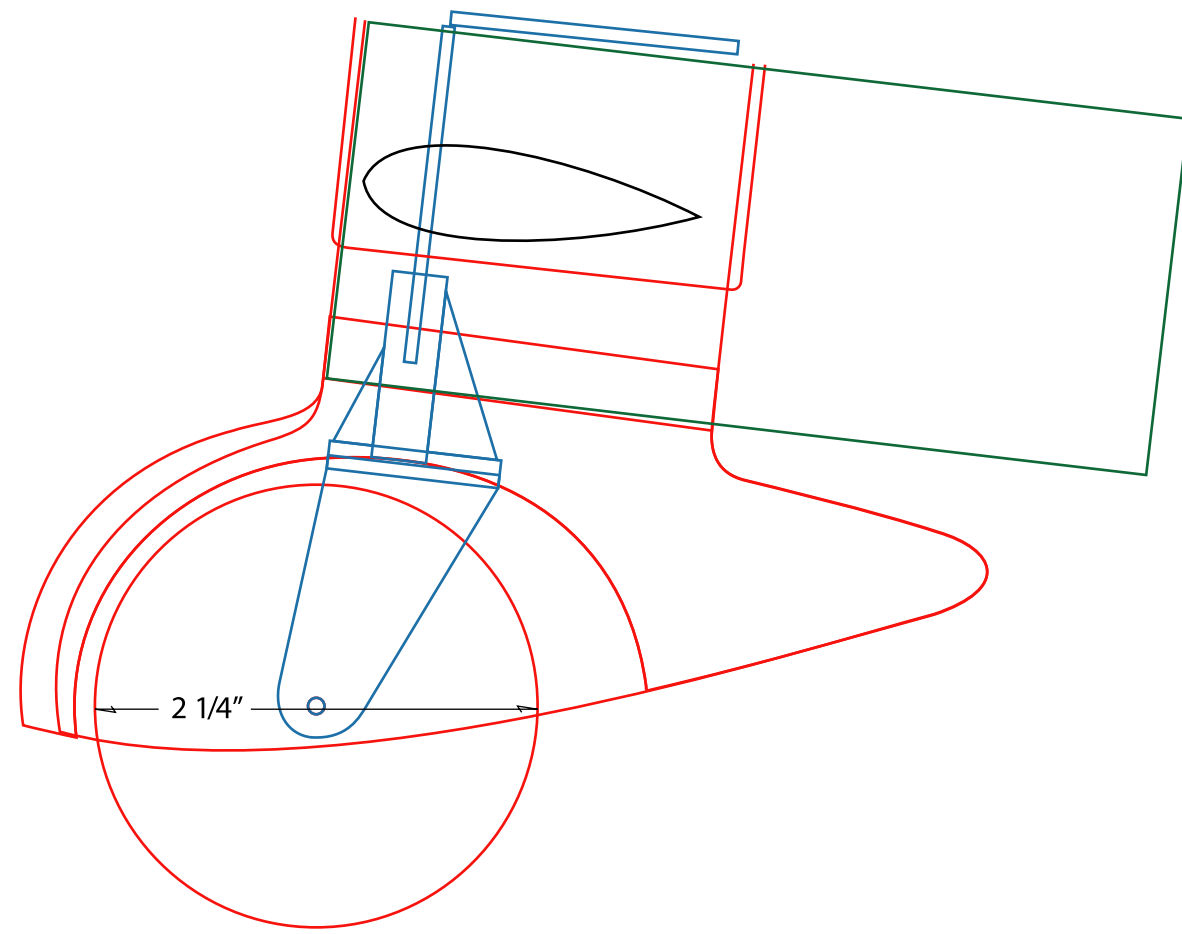

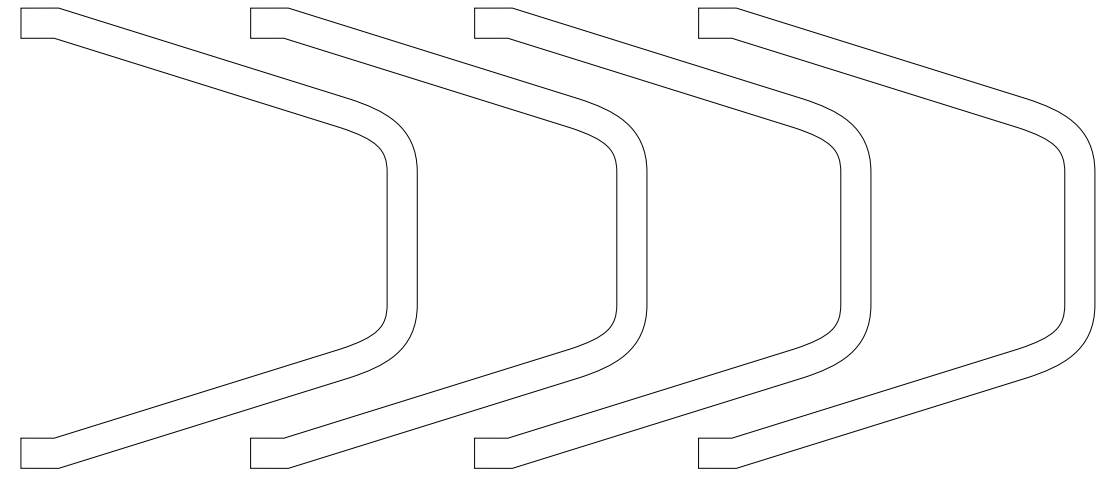
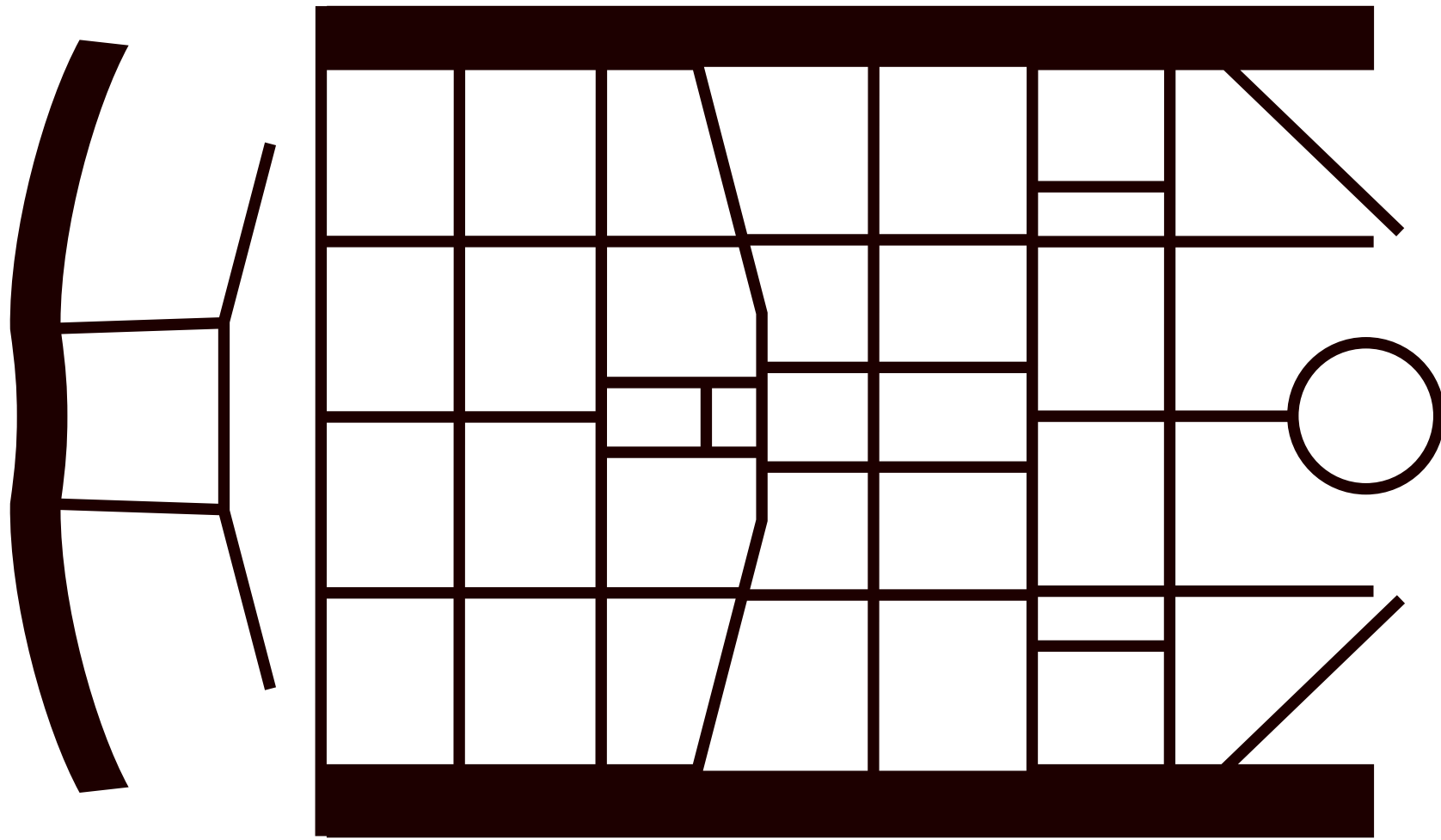

We made about six of these out of Hobby Plywood and wrapped the clear film around them for the cockpit.

We weren't really sure how to finish off the back of the canopy so we made a few slices in the plastic and taped it.

The Normal size canopy was a little short for scale. The Longer size canopy is a little closer to scale size

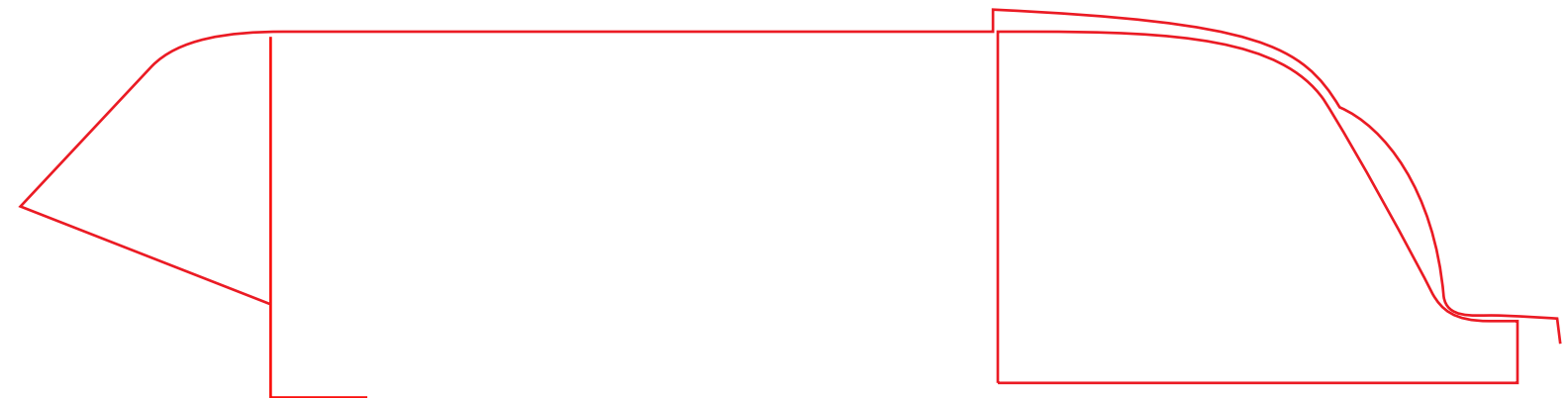
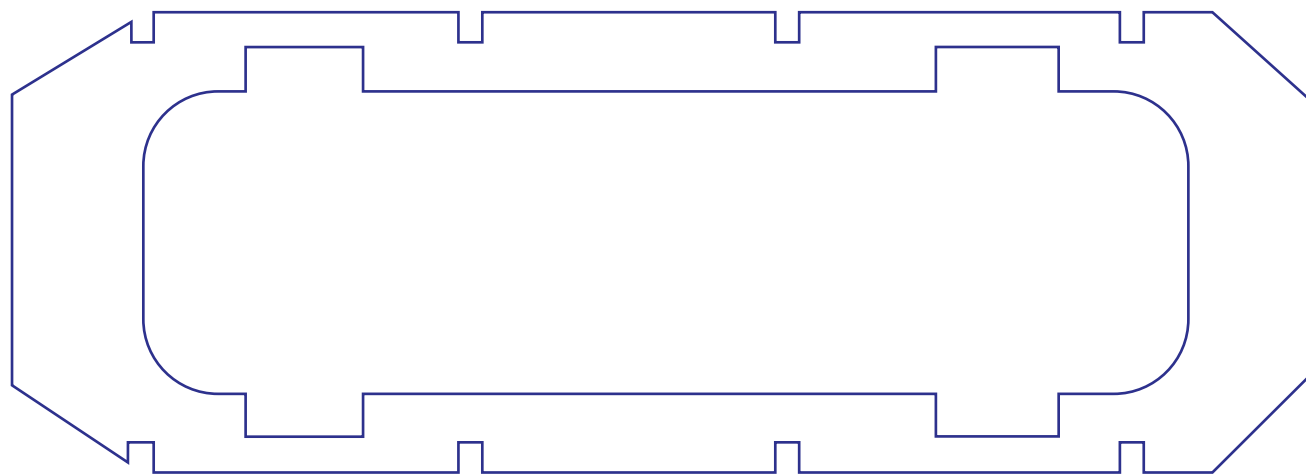
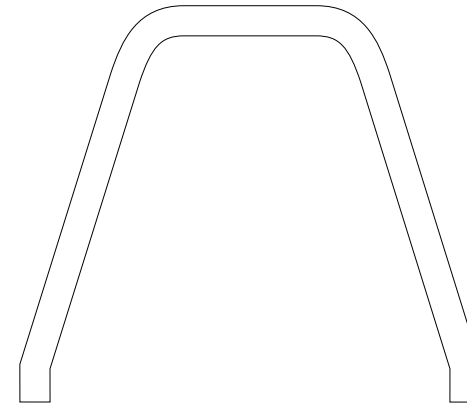

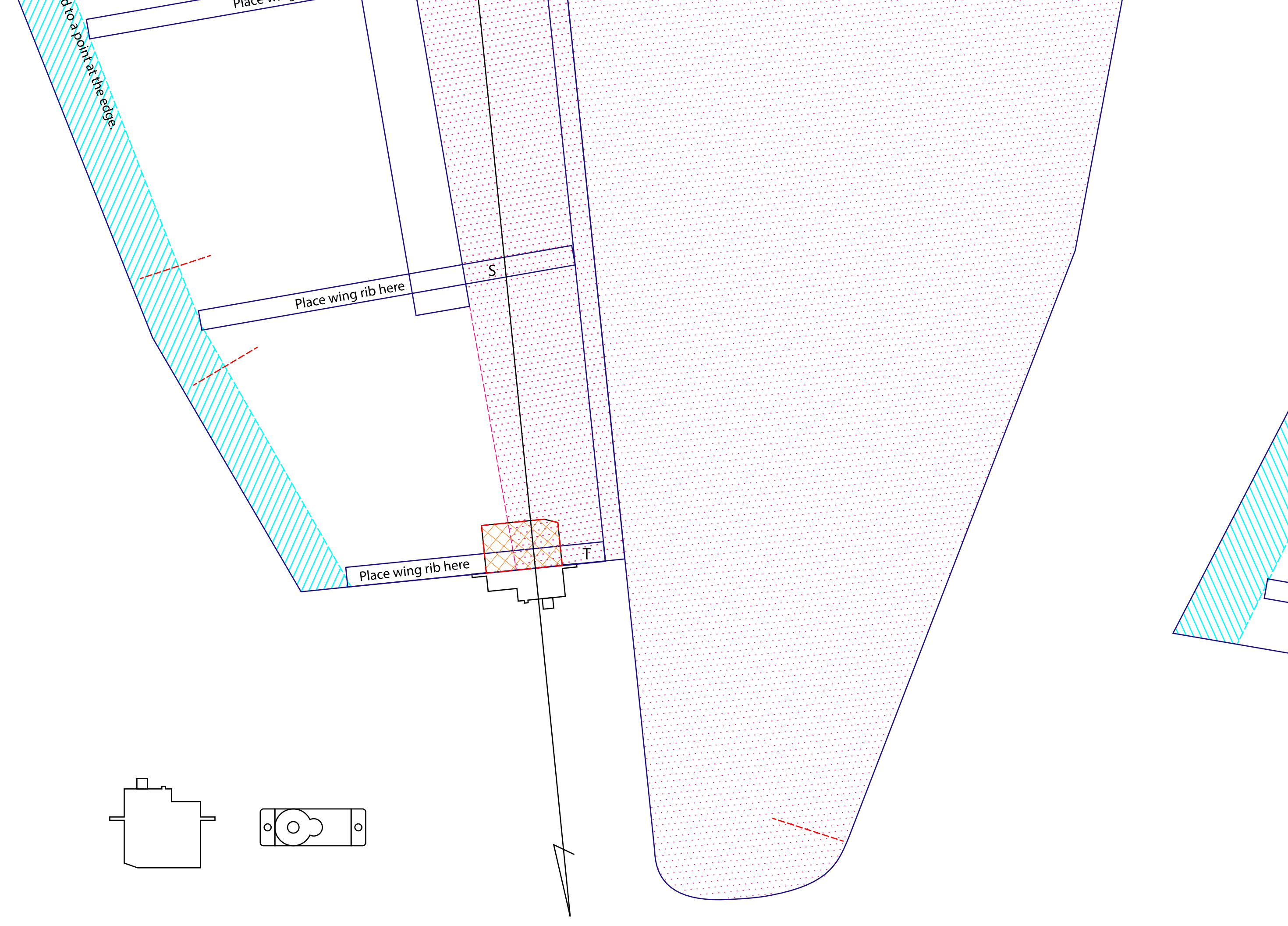

to a point at the edge.

Place wing

Place wing rib here

S

Place wing rib here

T

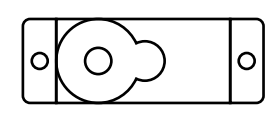
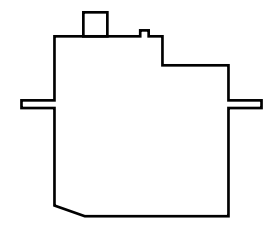

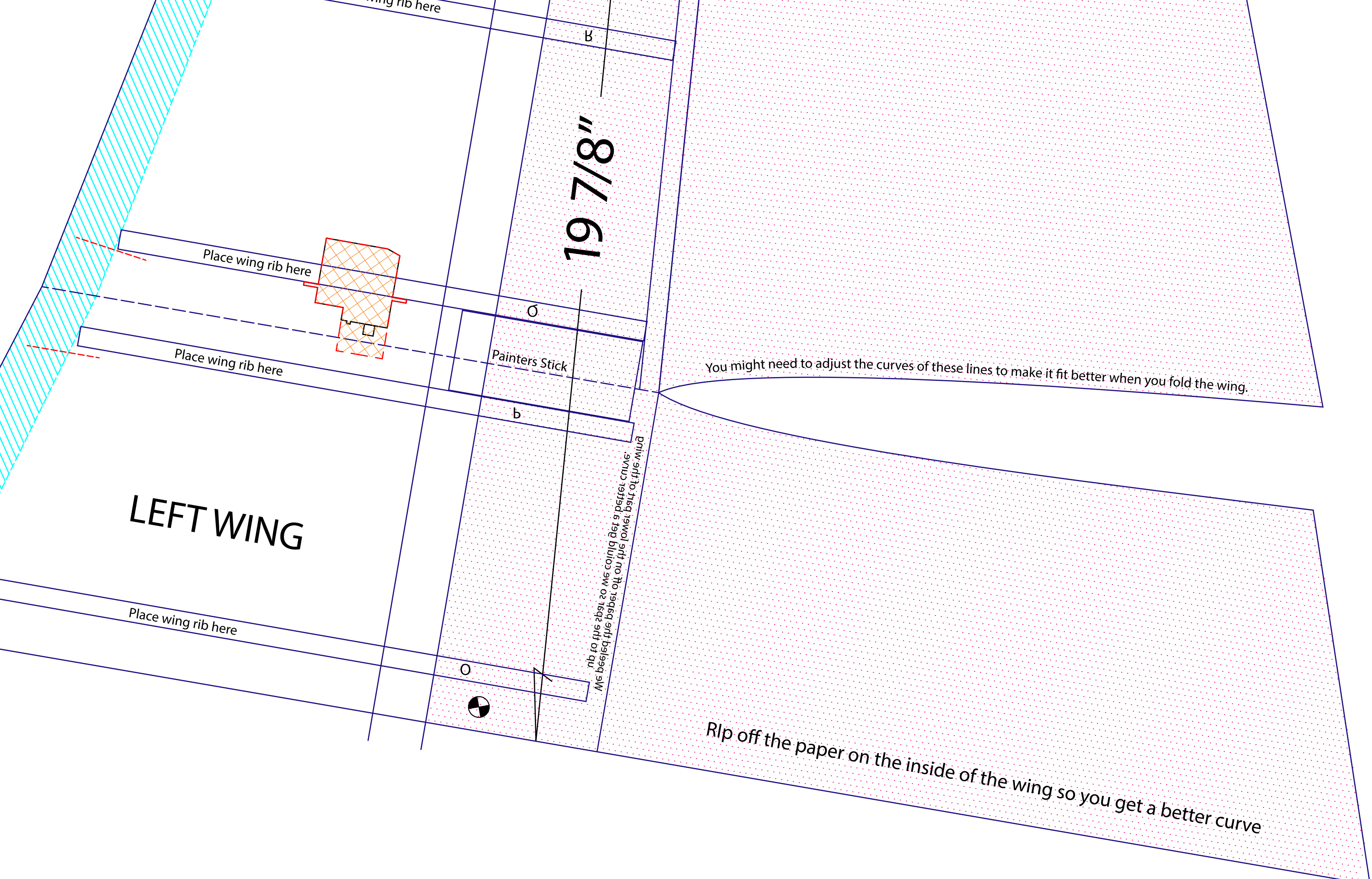

LEFT WING

19 7/8"

Place wing rib here

Place wing rib here

Place wing rib here

Painters Stick

You might need to adjust the curves of these lines to make it fit better when you fold the wing.

Rip off the paper on the inside of the wing so you get a better curve

nb fo the 2bri. so we could get a better curve. We beelq the baber off on the lower part of the midg